

# **National Standard for Commercial Vessels**

## **Part B    General requirements**

## Edition 2.4

This edition 2.4 was prepared by the Australian Maritime Safety Authority to incorporate the NSCV Omnibus amendments instrument No.1, 2022.

NSCV Omnibus amendments instrument No. 1, 2022 was approved by the National Marine Safety Regulator on 6 September 2022 and adopted by the Infrastructure and Transport Ministers on 11 November 2022.

This edition 2.4 commences on 1 January 2023.

Published by Australian Maritime Safety Authority, GPO Box 2181 Canberra, ACT 2601.

## Copyright



© Australian Maritime Safety Authority 2022

The Australian Maritime Safety Authority encourages the dissemination and exchange of information provided in this publication.

Except as otherwise specified, all material presented in this publication is provided under Creative Commons Attribution 4.0 International licence. This excludes:

- the Commonwealth Coat of Arms
- this Authority's logo
- content supplied by third parties.

The Creative Commons Attribution 4.0 International Licence is a standard form licence agreement that allows you to copy, distribute, transmit and adapt this publication provided that you attribute the work.

The details of the version 4.0 of the licence are available on the Creative Commons website, as is the full legal code for that licence.

## Attribution

The Australian Maritime Safety Authority's preference is that you attribute this publication (and any material sourced from it) using the following wording:

Source:

© Australian Maritime Safety Authority, *National Standard for Commercial Vessels, Part B – General Requirements*

## More information

For inquiries regarding copyright including requests to use material in a way that is beyond the scope of the terms of use that apply to it, please contact us.

## Disclaimer

Australian Maritime Safety Authority accepts no liability for the accuracy of the information nor its use or the reliance placed on it.

<b>Chapter 1</b>	<b>Preliminary.....</b>	<b>4</b>
1.1	Scope.....	4
1.2	Application .....	4
1.3	Objectives of this Part.....	4
1.4	Objective of the NSCV .....	4
1.5	Application of the NSCV .....	4
1.6	Meeting the Required Outcomes .....	4
1.7	References to standards.....	5
1.8	References to Sections or Subsections of the NSCV.....	5
1.9	Definitions — the dictionary .....	5
1.10	Interpretation.....	5
<b>Chapter 2</b>	<b>Categories of vessels .....</b>	<b>6</b>
2.1	Vessel use category.....	6
2.2	Operational areas and operational area categories .....	6
2.3	Operational area categories B and C — transitional arrangements.....	6
2.4	Vessel to be assigned a service category .....	7
2.5	Length restrictions for vessels to be assigned certain service categories.....	9
2.6	Vessels assigned multiple service categories .....	9
2.7	Restriction on operation of open vessels.....	9
2.8	Vessels conducting restricted offshore operations near parent vessels .....	10
<b>Chapter 3</b>	<b>General.....</b>	<b>11</b>
3.1	Classed vessels taken to comply.....	11
3.2	Novel vessels.....	11
3.3	Special purpose vessels .....	11
3.4	Design environmental parameters.....	11
3.5	Determination of vessel gross tonnage .....	12
3.6	Special personnel requirements .....	13
<b>Schedule 1</b>	<b>Method of calculation of depth of vessel.....</b>	<b>14</b>
<b>Schedule 2</b>	<b>Method of calculation of measured length of vessel .....</b>	<b>16</b>
<b>Schedule 3</b>	<b>Usual method of calculation of freeboard deck that is discontinuous or stepped .....</b>	<b>25</b>
<b>Dictionary.....</b>		<b>26</b>

## Chapter 1 Preliminary

### 1.1 Scope

This Part specifies the following:

- (a) the application and objectives of the NSCV;
- (b) a system for the categorisation of vessels;
- (c) methods for calculating the measured length, depth and gross tonnage of vessels;
- (d) a dictionary of definitions for the NSCV.

### 1.2 Application

This Part applies to domestic commercial vessels.

### 1.3 Objectives of this Part

- (1) This Part facilitates the consistent interpretation and shortening of the NSCV by:
  - (a) setting out definitions that generally apply in all Parts of the NSCV; and
  - (b) setting out rules of interpretation that apply in all Parts of the NSCV; and
  - (c) specifying methods for calculating the measured length, depth and gross tonnage of vessels.
- (2) This Part also provides a system for the categorisation of vessels so that other Parts of the NSCV may provide appropriate safety standards for the design, construction and operation of vessels in a service category.
- (3) This Part also facilitates industry innovation in developing solutions to control risks by providing for the approval by the National Regulator of equivalent means of compliance with any Part, Section or individual requirement of the NSCV.

### 1.4 Objective of the NSCV

The objective of the NSCV is to specify standards for domestic commercial vessels, including for the safe design and construction of vessels, crew competencies and the safe operation of vessels.

### 1.5 Application of the NSCV

- (1) The NSCV applies to domestic commercial vessels.
- (2) However, a Part, or a Section of a Part, of the NSCV may provide that:
  - (a) it does not apply to specified vessels; or
  - (b) it applies only to specified vessels.

*Note 1* Some Parts of the NSCV are prescribed standards for domestic commercial vessels under the national law — see *Marine Order 501 (Administration — national law) 2013*.

*Note 2* Parts of the NSCV may also apply to regulated Australian vessels if they are adopted by reference in a Marine Order made under the *Navigation Act 2012*.

### 1.6 Meeting the Required Outcomes

A vessel is taken to meet a required outcome if:

- (a) the deemed to satisfy solution that is specified for the required outcome is complied with; or
- (b) the vessel meets any equivalent means of compliance that is approved by the National Regulator under Division 4 of *Marine Order 503 (Certificates*

*of survey – national law) 2018 as providing the same level of safety as the deemed to satisfy solution; or*

- (c) the vessel meets an equivalent means of compliance approved by the Australian Maritime Safety Authority under the NSCV in force prior to 1 January 2018.

*Note* If the vessel has an approved equivalent means of compliance, the owner must ensure that the vessel also meets the other deemed to satisfy solutions mentioned in any Part, Section or Subsection of the NSCV that the approved equivalent means of compliance does not replace.

*Note 1:* This ensures that equivalent means of compliance approved under earlier versions of the NSCV continue to be recognised.”

## 1.7 References to standards

Unless otherwise provided, a national, regional or international standard that is adopted or incorporated by reference in the NSCV is adopted or incorporated by reference as in force from time to time.

## 1.8 References to Sections or Subsections of the NSCV

A reference in the NSCV to a Part from B to F, to a Section in a Part from C to F or to a Subsection from C5A to C7D or from F1A to F1C means that Section or Subsection of the NSCV.

*Note* For the definition of *sheltered waters* in section 4 of the *Marine Safety (Domestic Commercial Vessel) National Law Regulation 2013* that refers to section 1.8 of this Part — see the definition of *sheltered waters* in the dictionary.

## 1.9 Definitions — the dictionary

A definition in the dictionary in this Part applies to each use of the word or expression in each Part, Section and Subsection of the NSCV, unless otherwise provided in the Part, Section or Subsection.

## 1.10 Interpretation

In the NSCV, a vessel is taken to be *in waters to the outer limits of the EEZ* if it is in the Protected Zone.

*Note 1* Waters to the outer limits of the EEZ include:

- (a) the territorial sea of Australia; and
- (b) waters to the landward side of the territorial sea of Australia.

*Note 2* Waters to the landward side of the territorial sea include inland waters.

## Chapter 2 Categories of vessels

### 2.1 Vessel use category

- (1) A kind of vessel mentioned in an item in the following table has the vessel use category mentioned in the item.

Item	Kind of vessel	Vessel use category
1	Passenger vessel	1
2	Non-passenger vessel	2
3	Fishing vessel	3
4	Hire and drive vessel used by the hirer only for recreational purposes	4

- (2) A hire and drive vessel that is not used by the hirer only for recreational purposes has the vessel use category mentioned in subsection (1) that is assigned to the vessel by the National Regulator after considering its intended use.

*Note* The National Regulator may, under subsection (2), assign a hire and drive vessel more than 1 vessel use category under subsection (2).

### 2.2 Operational areas and operational area categories

- (1) A vessel operational area mentioned in an item in the following table is indicated by the letter and any adjacent word mentioned in the item.

Item	Operational area	Operational area category
1	Unlimited domestic operations	A
2	Extended offshore operations	B extended
3	Offshore operations	B
4	Restricted offshore operations	C
5	Restricted offshore operations — specified areas	C restricted
6	Partially smooth water operations	D
7	Smooth water operations	E

*Note* A vessel operational area is either a seagoing operational area or a sheltered waters operational area — see the definitions of *seagoing operational area* and *sheltered waters operational area* in the dictionary.

- (2) A vessel may operate only in the geographical area mentioned in:
- the operational area indicated by a service category assigned to the vessel under subsection 2.4(1); or
  - any operational area mentioned in column 2 of the table to subsection (1) that is below the operational area indicated by the assigned service category.

### 2.3 Operational area categories B and C — transitional arrangements

A vessel that, before the commencement of this Part, was assigned a service category with a vessel operational area of offshore operations or restricted

offshore operations is taken to have been assigned the equivalent service category with the operational area as defined in this Part.

## 2.4 Vessel to be assigned a service category

- (1) The National Regulator must assign the vessel a service category mentioned in the following table according to the kind of vessel that it is, or is intended to be, and its intended operations.

*Note 1* The owner of a vessel will tell the National Regulator in an application for a national law certificate about the kind of vessel that it is, or is intended to be, and its intended operations.

*Note 2* The service category assigned to the vessel will be stated in the certificate of operation or certificate of survey issued by the National Regulator for the vessel.

- (2) Before assigning the vessel a service category, the National Regulator must be satisfied that the vessel meets, or will meet when constructed, the requirements of the service category.
- (3) A service category is the word ‘Class’ followed by:
- (a) the vessel use category of the vessel that is mentioned in subsection 2.1(1); and
  - (b) an operational area category mentioned in section 2.2.
- (4) For service category Class 2C restricted or Class 3C restricted, a **specified area** is an area that is mentioned in the list of specified areas determined by the National Regulator for this section.

*Note* The list of specified areas is available on the AMSA website at <http://www.amsa.gov.au>.

Service category	Description
Class 1A	Seagoing passenger vessel for use in all operational areas up to and including unlimited domestic operations
Class 1B extended	Seagoing passenger vessel: <ol style="list-style-type: none"> <li>(a) for use beyond 200 nm from the baseline of any of the following but in waters to the outer limits of the EEZ:               <ol style="list-style-type: none"> <li>(i) the Australian mainland;</li> <li>(ii) the Tasmanian mainland;</li> <li>(iii) a recognised island; and</li> </ol> </li> <li>(b) that complies with NSCV requirements for passenger vessels for use in the operational area unlimited domestic operations</li> </ol>
Class 1B	Seagoing passenger vessel for use in all operational areas up to and including offshore operations
Class 1C	Seagoing passenger vessel for use in all operational areas up to and including restricted offshore operations
Class 1D	Sheltered waters passenger vessel for operations in partially smooth and smooth waters only
Class 1E	Sheltered waters passenger vessel for use in smooth waters only
Class 2A	Seagoing non-passenger vessel for use in all operational areas up to and including unlimited domestic operations
Class 2B extended	Seagoing non-passenger vessel:

<b>Service category</b>	<b>Description</b>
	<ul style="list-style-type: none"> <li>(a) for use beyond 200 nm from the baseline of any of the following but in waters to the outer limits of the EEZ:               <ul style="list-style-type: none"> <li>(i) the Australian mainland;</li> <li>(ii) the Tasmanian mainland;</li> <li>(iii) a recognised island; and</li> </ul> </li> <li>(b) that complies with NSCV requirements for non-passenger vessels for use in the operational area unlimited domestic operations</li> </ul>
Class 2B	Seagoing non-passenger vessel for use in all operational areas up to and including offshore operations
Class 2C	Seagoing non-passenger vessel for use in all operational areas up to and including restricted offshore operations
Class 2C restricted	Seagoing non-passenger vessel for use in: <ul style="list-style-type: none"> <li>(a) smooth waters; or</li> <li>(b) partially smooth waters; or</li> <li>(c) a specified area determined by the National Regulator for subsection 2.4 (4)</li> </ul>
Class 2D	Sheltered waters non-passenger vessel for operations in partially smooth and smooth waters only
Class 2E	Sheltered waters non-passenger vessel for use in smooth waters only
Class 3A	Seagoing fishing vessel for use in all operational areas up to and including unlimited domestic operations
Class 3B extended	Seagoing fishing vessel: <ul style="list-style-type: none"> <li>(a) for use beyond 200 nm from the baseline of any of the following but in waters to the outer limits of the EEZ:           <ul style="list-style-type: none"> <li>(i) the Australian mainland;</li> <li>(ii) the Tasmanian mainland;</li> <li>(iii) a recognised island; and</li> </ul> </li> <li>(b) that complies with NSCV requirements for fishing vessels for use in the operational area unlimited domestic operations</li> </ul>
Class 3B	Seagoing fishing vessel for use in all operational areas up to and including offshore operations
Class 3C	Seagoing fishing vessel for use in all operational areas up to and including restricted offshore operations
Class 3C restricted	Seagoing fishing vessel for use in: <ul style="list-style-type: none"> <li>(a) smooth waters; or</li> <li>(b) partially smooth waters; or</li> <li>(c) a specified area determined by the National Regulator for subsection 2.4 (4)</li> </ul>



<b>Service category</b>	<b>Description</b>
Class 3D	Sheltered waters fishing vessel for operations in partially smooth and smooth waters only
Class 3E	Sheltered waters fishing vessel for use in smooth waters only
Class 4C	Seagoing hire and drive vessel for use in all operational areas up to and including restricted offshore operations
Class 4D	Sheltered waters hire and drive vessel for operations in partially smooth and smooth waters only
Class 4E	Sheltered waters hire and drive vessel for use in smooth waters only

## **2.5 Length restrictions for vessels to be assigned certain service categories**

A vessel may be assigned service category Class 1A, 1B extended, 1B or 1C only if it is  $\geq 10$  m long.

*Note* **Long** means measured length — see definition of **long** in the dictionary.

## **2.6 Vessels assigned multiple service categories**

- (1) A vessel may be assigned more than 1 service category if the kind of vessel that it is or its operations are not adequately described by 1 service category.
- (2) A vessel that has been assigned more than 1 service category must comply with the requirements of the highest of those service categories and any additional requirements of the other service categories to which it is assigned.

## **2.7 Restriction on operation of open vessels**

An open vessel may carry passengers in operational area C only if:

- (a) it is a rigid inflatable boat, collared vessel or inflatable boat that is in service category Class 2C, 3C or 4C; or
- (b) it is a kind of open vessel, other than a rigid inflatable boat, collared vessel or inflatable, that is:
  - (i) in service category Class 2C, 3C or 4C; and
  - (ii) has level flotation; or
- (c) it is a kind of open vessel, other than a rigid inflatable boat, collared vessel or inflatable, that:
  - (i) is  $\geq 12$  m long; and
  - (ii) is in service category Class 2C, 3C or 4C; and
  - (iii) has mechanical and manual means of pumping bilge water from each compartment that complies with Subsection C5A — *Machinery*; and
  - (iv) when in the swamped condition at maximum draft and upright — can drain all flooded compartments and recesses within 3 minutes; and
  - (v) is restricted to operating in daylight hours  $\leq 5$  nm to sea from the baseline of any of the following:
    - (A) the Australian mainland;
    - (B) the Tasmanian mainland;
    - (C) a recognised island;

(D) its parent vessel.

## 2.8 Vessels conducting restricted offshore operations near parent vessels

- (1) A vessel that is in the operational area restricted offshore operations because it must stay within 30 nm from its parent vessel must have arrangements in place for the following matters so that the safety of the vessel and its parent vessel is not compromised in any sea conditions:
  - (a) the recovery of persons on board the vessel;
  - (b) the securing of the vessel to the parent vessel.
- (2) The vessel may operate only in sea and weather conditions that:
  - (a) comply with the requirement mentioned in the table to section 3.4 for operational area category C for the design parameter *weather and sea characteristics*; and
  - (b) are within the limits mentioned for operational area category C for the following design parameters in the table:
    - (i) *Beaufort scale*;
    - (ii) *assumed gusting wind pressure (Pa)*;
    - (iii) *design significant wave height (m)*.

*Note* The vessel must also comply with the design parameter requirements mentioned in the table to section 3.4 for operational area category C.

## Chapter 3 General

### 3.1 Classed vessels taken to comply

- (1) A vessel designed, constructed and surveyed by a recognised organisation in accordance with the recognised organisation's class rules (however described):
  - (a) is taken to comply with the requirements of the NSCV that are also requirements of the class rules; and
  - (b) is subject to any conditions mentioned in the certificate of classification for the vessel.
- (2) If the recognised organisation's class rules provide that a requirement of the vessel's flag state is to apply, the NSCV requirement applies.

### 3.2 Novel vessels

- (1) If the National Regulator considers that a vessel does not have the shape, form, function or propulsion of most vessels of a similar kind, the National Regulator may categorise the vessel as a novel vessel.

*Note 1* A vessel that is similar to another vessel of its kind may be considered to be a novel vessel.

*Note 2* See the AMSA website at <http://www.amsa.gov.au> for information about vessels the National Regulator considers to be novel.

- (2) A novel vessel must be constructed and maintained in accordance with the class rules of a recognised organisation.

### 3.3 Special purpose vessels

A special purpose vessel must meet the requirements of the NSCV for vessel use category 1 (*Class 1 vessel*).

### 3.4 Design environmental parameters

A vessel that is for use in an operational area mentioned in the following table must comply with the requirements for each design parameter mentioned in the table for the operational area.

Design parameter	Operational areas category A and category B extended	Operational area category B	Operational areas category C and category C restricted	Operational area category D	Operational area category E
Operational characteristics	Independent operation at sea	Independent operation at sea	Restricted operation within a few hours travel of the coast	Operation in sheltered waters	Operation in smooth waters
Weather and sea characteristics	Survives all but the most extreme weather or sea conditions	Survives all but the most extreme weather or sea conditions	Avoids gale-force weather and very rough seas	Avoids gale-force weather and rough seas	Avoids gale-force weather and operates only in small waves

Design parameter	Operational areas category A and category B extended	Operational area category B	Operational areas category C and category C restricted	Operational area category D	Operational area category E
Survival and rescue infrastructure	Early rescues not likely Possible lengthy period in survival mode	Planes for early location and helicopters for rescue out to about 100 nm	Survival in benign conditions or rescue within a relatively short time	Rescue facilities or shoreline nearby	Rescue facilities or shoreline readily available
Assumed gusting wind pressure (Pa)	600	600	450	360	300
Beaufort scale	9 (strong gale)	9 (strong gale)	7 (near gale)	6 (strong breeze)	6 (strong breeze)
Design significant wave height (m)	>6	>6	4.5	2.5	0.6
Water temperature	7-37°C	7-37°C	7-37°C	7-37°C	7-37°C
Air temperature	1-45°C	1-45°C	1-45°C	1-45°C	1-45°C

*Note* information can be obtained from the Bureau of Meteorology's website at <http://www.bom.gov.au> about marine related environmental parameters, eg wind, wave, water and air temperature.

### 3.5 Determination of vessel gross tonnage

- (1) If the NSCV requires a vessel to comply with an international standard for which the gross tonnage of the vessel must be calculated, the gross tonnage of the vessel must be calculated:
- in accordance with the Tonnage Convention; or
  - if the vessel is <80 m long — as:

$$\frac{K_{Block} \times L \times B \times D}{2.83}$$

where:

***K*Block** is:

- for a barge — 0.84; or
- for a sailing vessel — 0.5; or
- for a vessel that is not a sailing vessel or a barge — 0.67.

***L*** is the length overall of the vessel, in metres.

***B*** is the breadth of the vessel, in metres.

***D*** is the depth of the vessel, in metres.

*Note* For definitions of ***overall length***, ***breadth*** and ***depth*** for a vessel — see the dictionary.

- (2) For paragraph (1)(b), if the volume of the vessel's hull is less than the volume of the principal deck structure of the vessel:
- (a) the gross tonnage of the vessel calculated in accordance with paragraph (1)(b) must be increased by 1 tonne for every 2.85 m<sup>3</sup> of superstructure volume; and
  - (b) the volume of the principal deck structure of the vessel must be determined by the product of its average dimensions.

*Note 1* The NSCV is length based while international standards for trading vessels (eg STCW) are tonnage based. Tonnage is a measurement based on the enclosed volume of the vessel.

*Note 2* Examples of international standards are IMO conventions and codes and ISO standards.

- (3) However, the gross tonnage of a vessel for a certificate of competency is the equivalent gross tonnage mentioned in the following table for a vessel of the measured length mentioned in the table.

<b>Item</b>	<b>Measured length (metres)</b>	<b>Equivalent gross tonnage</b>
1	12	20
2	24	80
3	30	200
4	35	500
5	45	1000
6	80	3000
7	120	7000

### **3.6 Special personnel requirements**

Special personnel on a vessel must be inducted and trained in accordance with the vessel's safety management system.

## Schedule 1 Method of calculation of depth of vessel

(Definition of *depth* — see dictionary)

### 1 Method of calculation of vessel depth

- (1) The depth of a vessel is calculated by measuring the moulded depth of the vessel at the middle of the measured length of the vessel from the moulded line of the keel to the top of the freeboard deck beams at the side of the vessel.
- (2) In subclause (1):

*middle of the measured length* means:

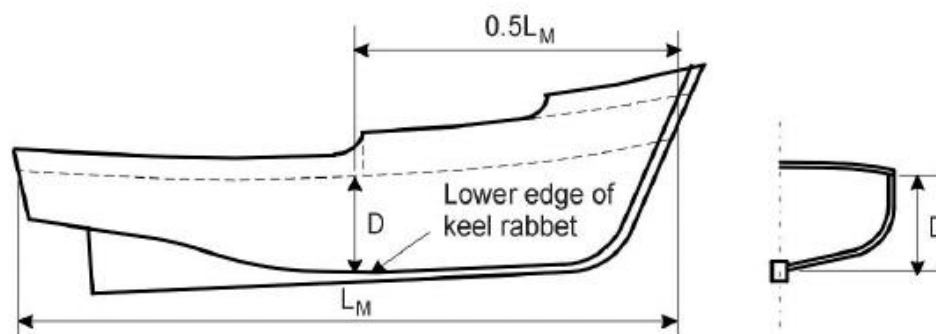
- (a)  $0.5 L_M$  from the fore part of the hull when the measured length is based on the length on deck ( $L_D$ ); or
- (b)  $0.5 L_M$  from the foremost part of the hull when the measured length is based on 96% of the length overall ( $L_{OA}$ ).

*Note* See the definition of *measured length* in the dictionary and see also Schedule 2. For definitions of *length on deck* and *length overall* — see the dictionary.

*moulded line of the keel* means:

- (a) the top of the keel if a plate keel is fitted, as shown in Figure 1(b); or
- (b) for a timber or composite vessel — the lower edge of the keel rabbet as shown in Figure 1(a); or
- (c) for a vessel with a bar keel:
  - (i) as shown in Figure 1(d); or
  - (ii) if the lower part of the vessel is hollow or the vessel has thick garboards fitted — the point where the flat of bottom continued inwards cuts the side of the keel of the vessel, as shown in Figure 1(c).
- (3) The moulded line of the keel must be horizontal when extended transversely.

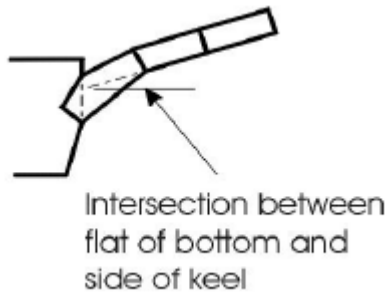
**Figure 1 Measurement of the depth of a vessel**



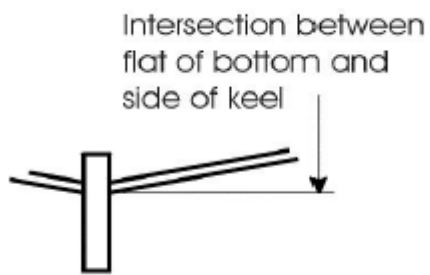
a) Timber deck with rise of keel and deck camber



b) Flat plate keel



c) Vessel with hollow garboards



d) Vessel with bar keel



## Schedule 2 Method of calculation of measured length of vessel

(Definition of *measured length* – see dictionary)

*Note* The NSCV imposes requirements on vessels of a measured length for the following:

- the seagoing operation of passenger vessels
- the limits of the detailed NSCV construction and machinery provisions
- crewing and competency requirements
- load line, weathertight and watertight integrity
- accommodation and railing requirements
- fire safety and equipment
- lifesaving equipment
- stability standards.

### 1 Method of calculation of measured length

The measured length of a vessel is the greater of:

- (a) the length on deck, in metres ( $L_D$ ); and
- (b) 0.96 times the length overall, in metres ( $L_{OA}$ ).

*Note 1* For definitions of *length on deck* and *length overall* — see the dictionary.

*Note 2* For guidance about measuring length on deck and length overall — see Figure 2.

### 2 Method for measuring vessel length

- (1) The measured length of a vessel must be measured in accordance with this clause.
- (2) The measurement must be taken in a direct line parallel to the design waterline between the defined extremities of the vessel.

*Note* For the definition of *design waterline* — see the dictionary. For the definition of *extremities* — see subclause (6).

- (3) If the vessel is afloat, the measurement must be taken by setting up sight boards at the stem and stern of the vessel, together with as many intermediate sights as are necessary to circumvent obstructions or breaks in the uppermost weathertight deck.

*Note* For guidance — see Figure 3.

- (4) If the vessel is onshore, the measurement may be taken:
  - (a) by setting up sight boards at the stem and stern of the vessel, together with as many intermediate sights as are necessary to circumvent obstructions or breaks in the uppermost weathertight deck; or
  - (b) by setting up plumb lines dropped from the extremities of the vessel.
- (5) For paragraph (4)(b), if the lengths are measured with the design waterline not horizontal, the measurement must be corrected for the difference in declivity.

*Note* See Figure 3(b) for the application of this method on a vessel that is on a steeply angled slipway.

- (6) In subclause (2) *extremities* means:
  - (a) for measuring length on deck ( $L_D$ ) — the fore part and the after part of the hull; and
  - (b) for measuring length overall ( $L_{OA}$ ) — the foremost part and the aftermost part of the hull.

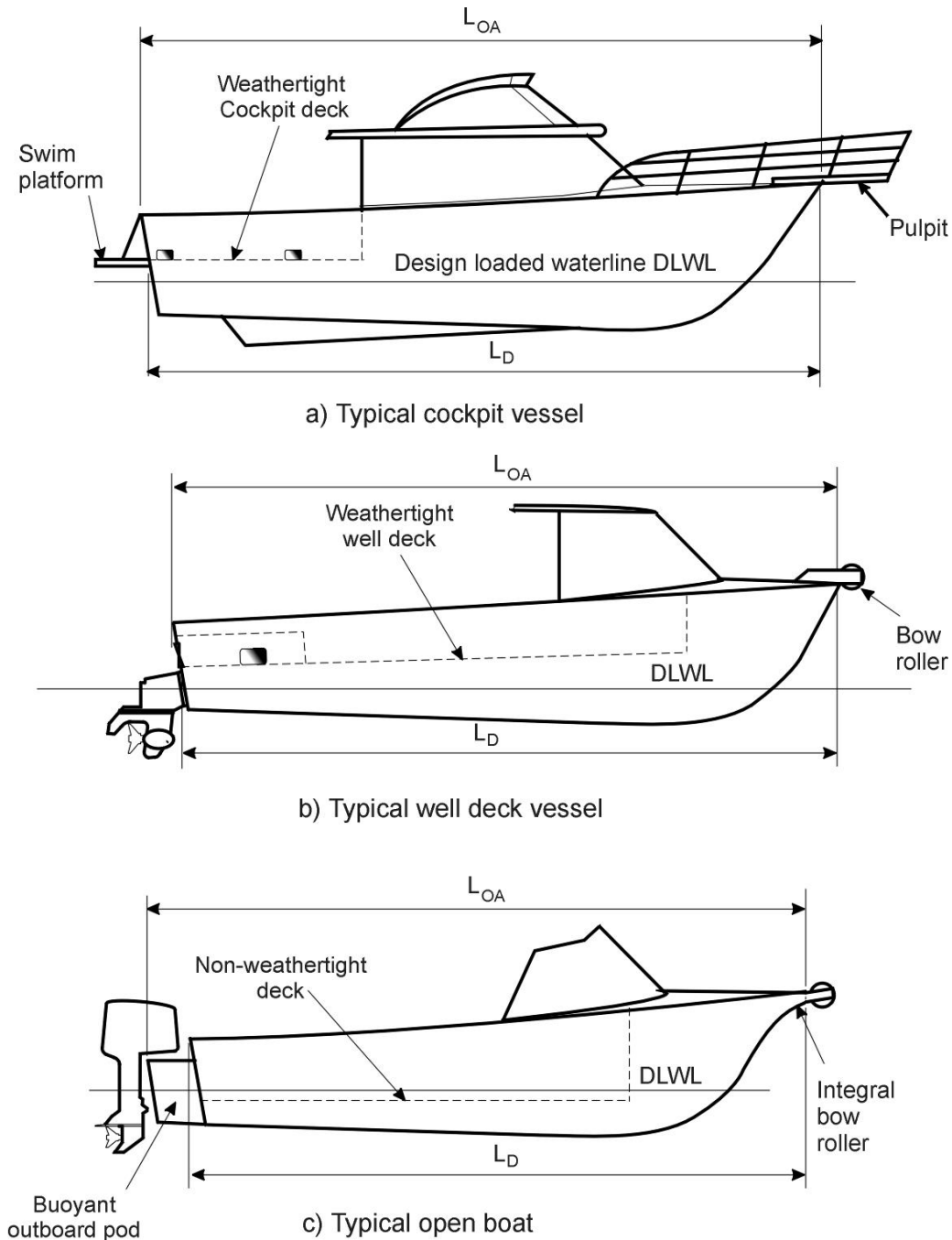
*Note* For guidance — see Figure 2.



### 3 Unusual vessels

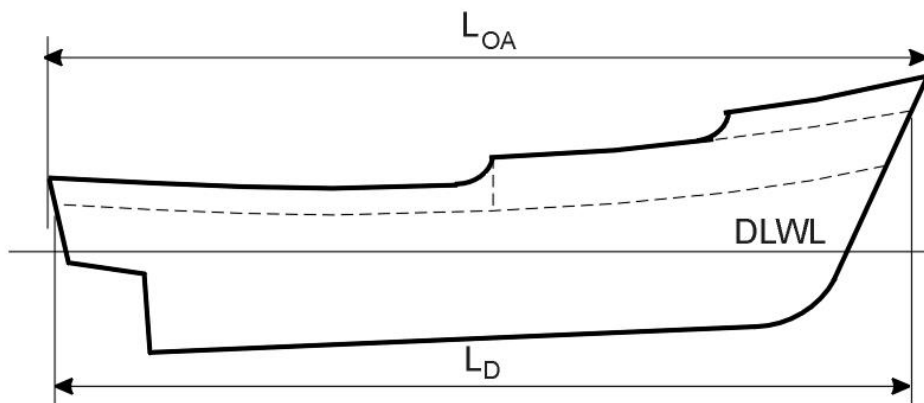
If the physical characteristics of a vessel prevent its length being measured in accordance with clause 2, the National Regulator may determine another measurement method to be used after considering the risks associated with the vessel when compared to those of vessels of a similar size and service category.

**Figure 2 Guidance on measuring length**

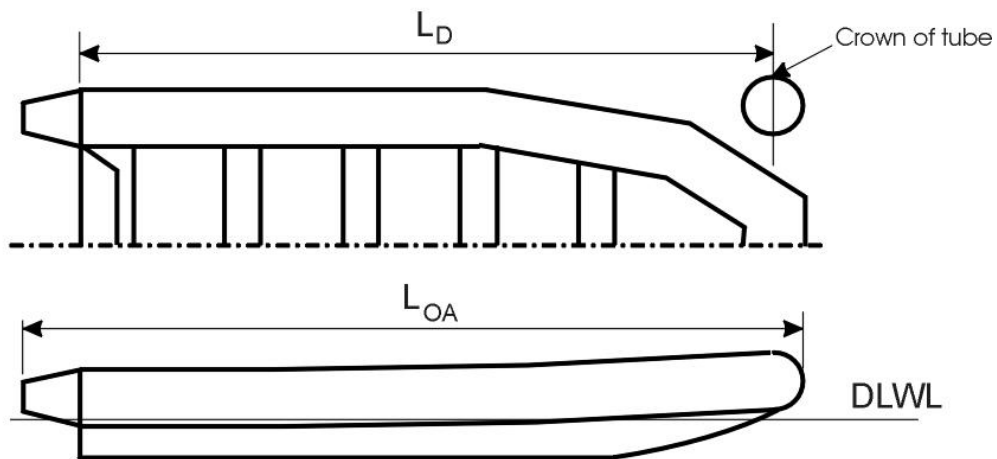




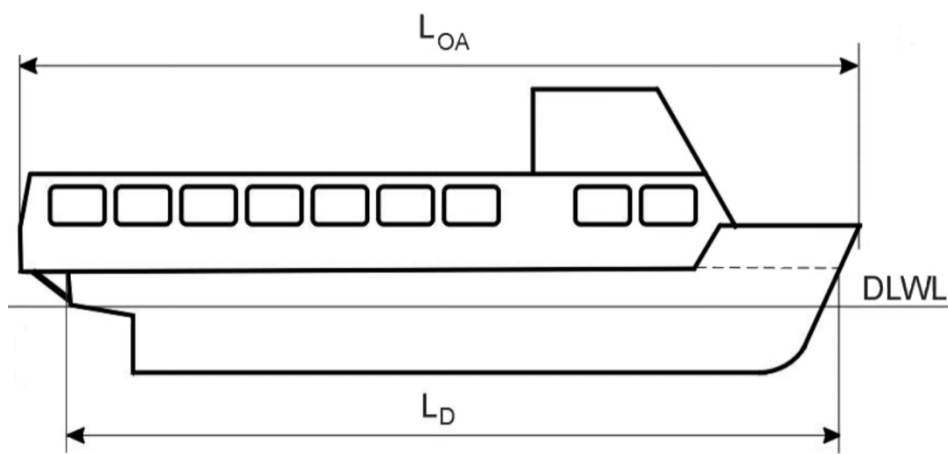
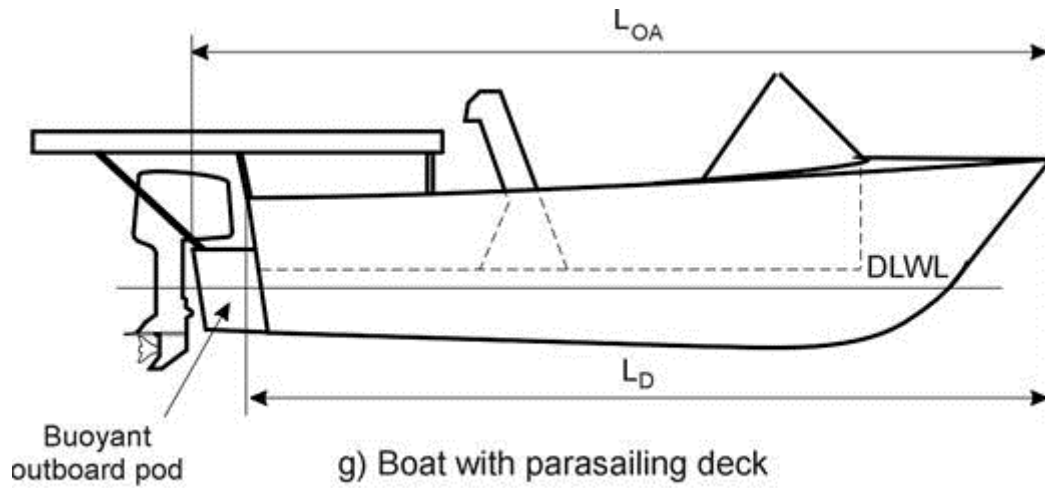
d) Raised fo'c'sle and poop deck



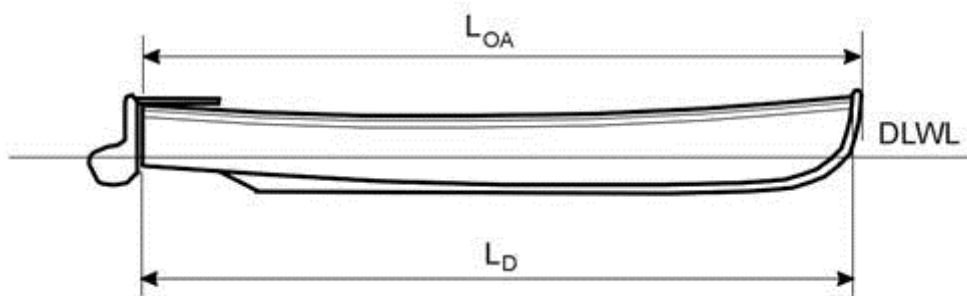
e) Overhang of solid bulwarks



f) RIB or Inflatable

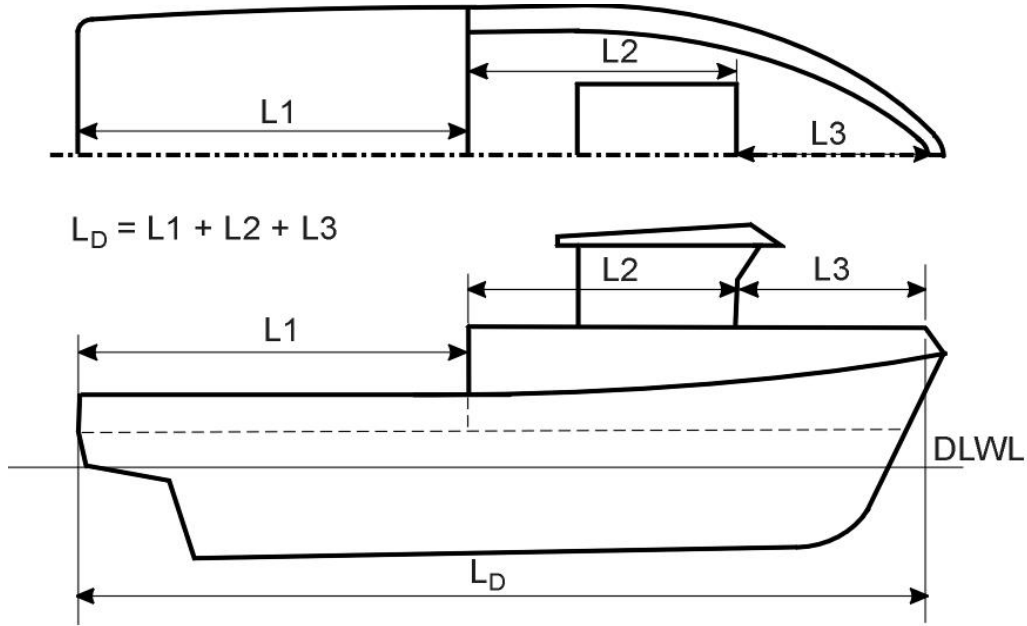


h) Overhanging deck included in deck area calculation

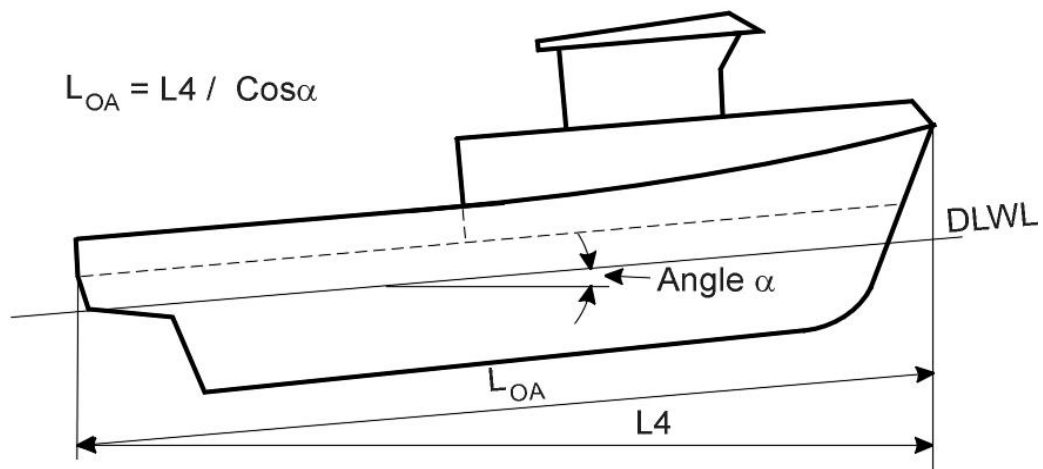


i) Open launch

**Figure 3 Methods for measuring length**

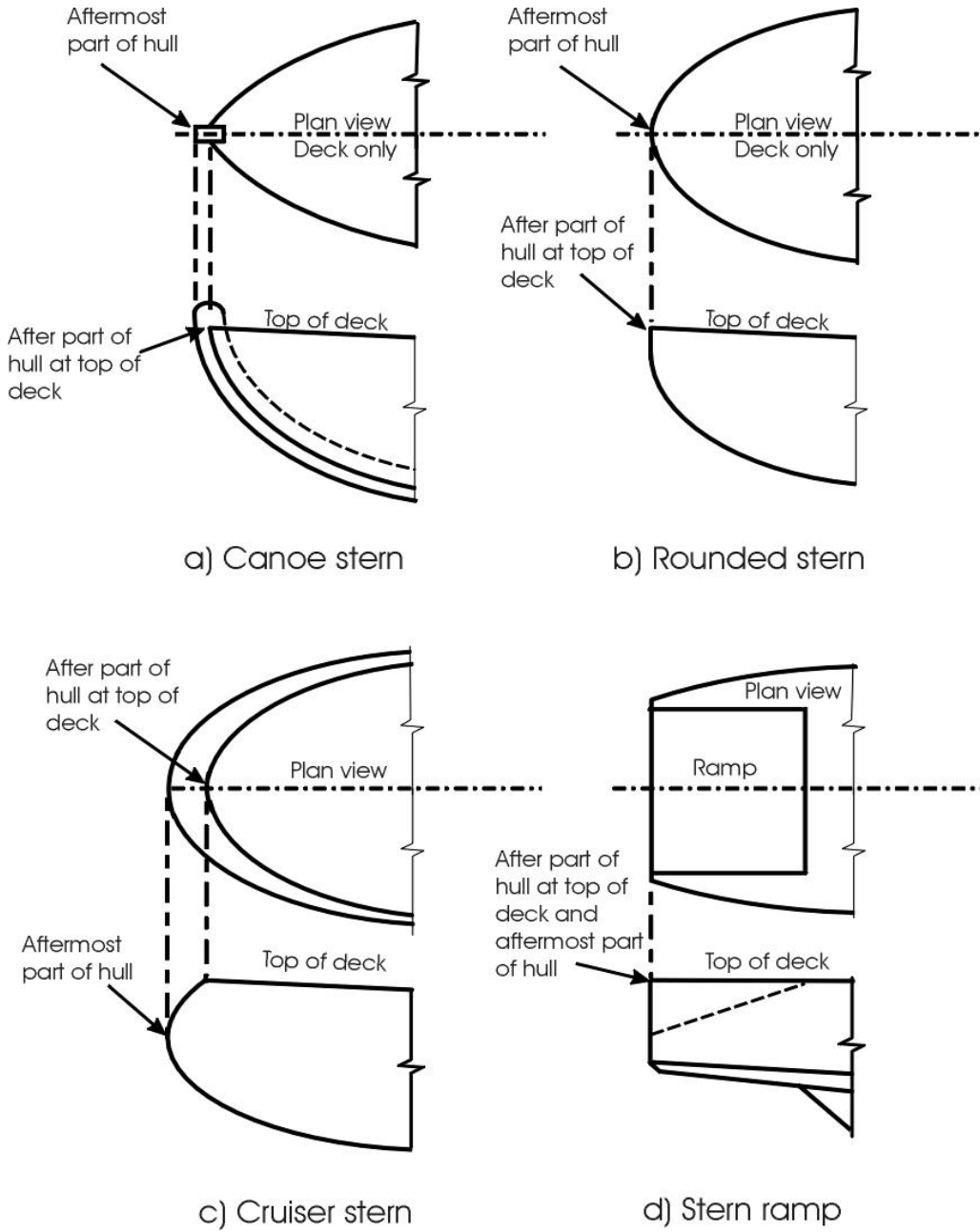


a) Measurement using sight boards ashore or afloat

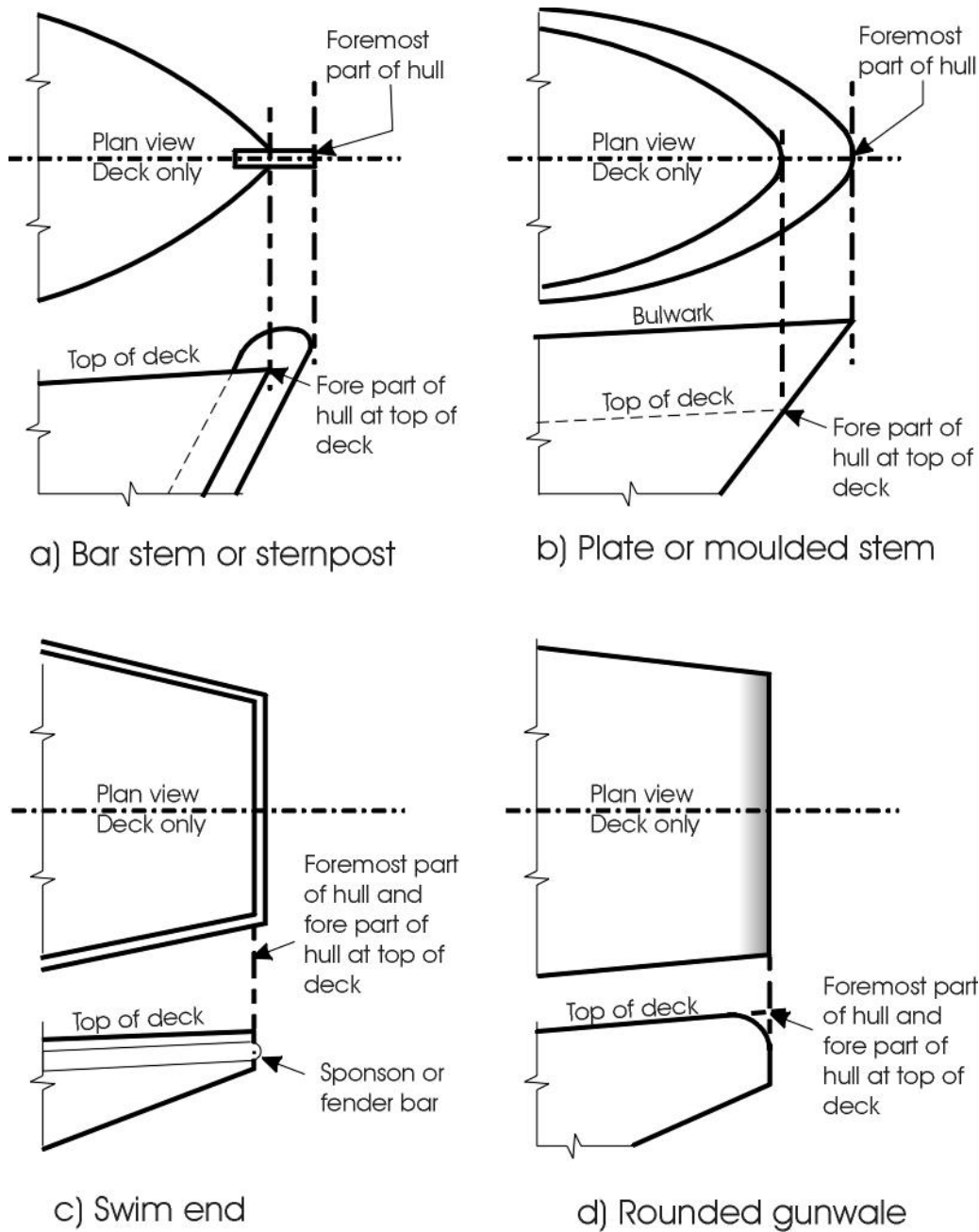


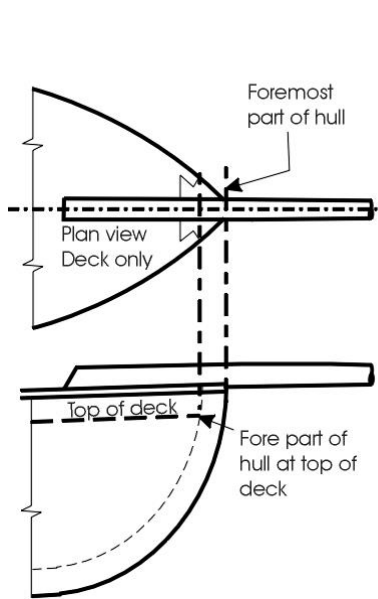
b) Measurement on-shore using plumb-bobs

**Figure 4 Reference points at aft end of a vessel**

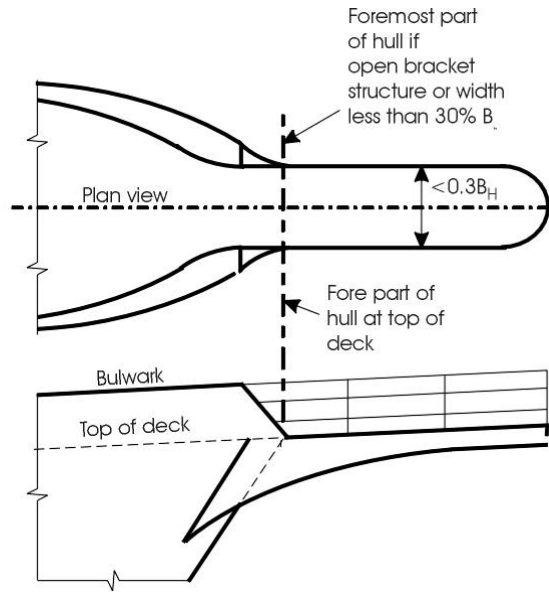


**Figure 5 Reference points at the fore end of a vessel**

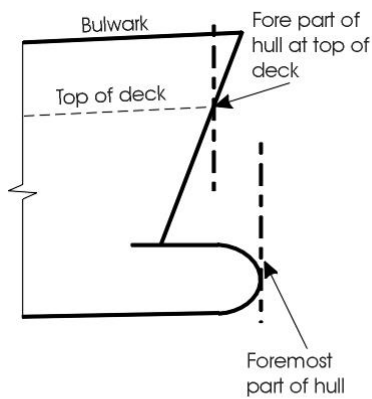




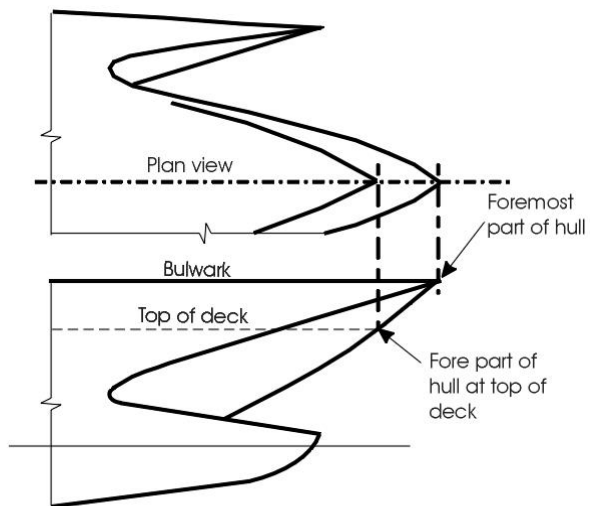
e) Attached bowsprit



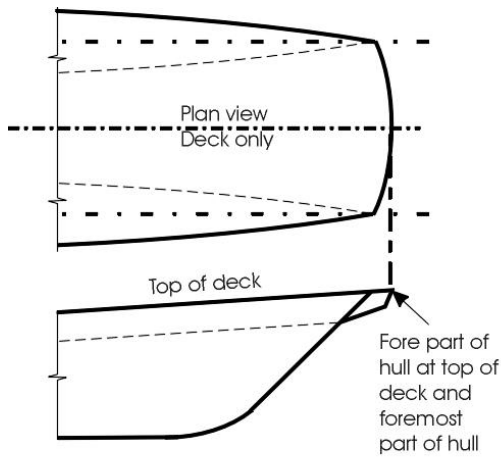
f) Overhanging pulpit / long-lining platform



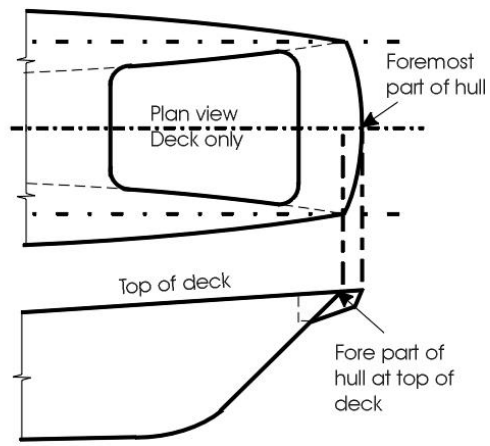
g) Bulbous bow



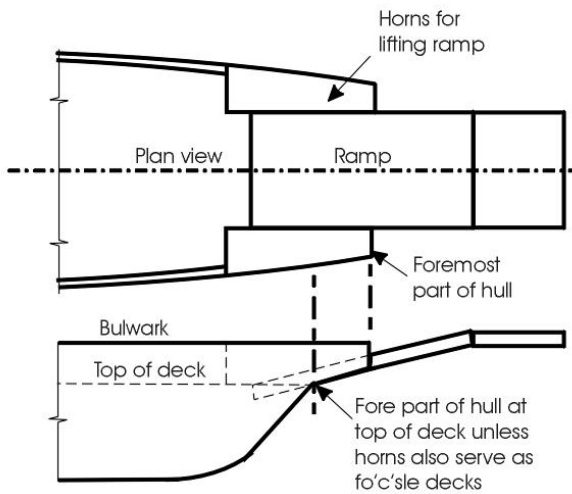
h) Wavepiercer bow



i) Catamaran with buoyant bridging deck or overhanging deck included in deck areas



j) Catamaran with bridging beam not intended for the carriage of persons



k) Overhanging ramp on landing barges and vehicular ferries



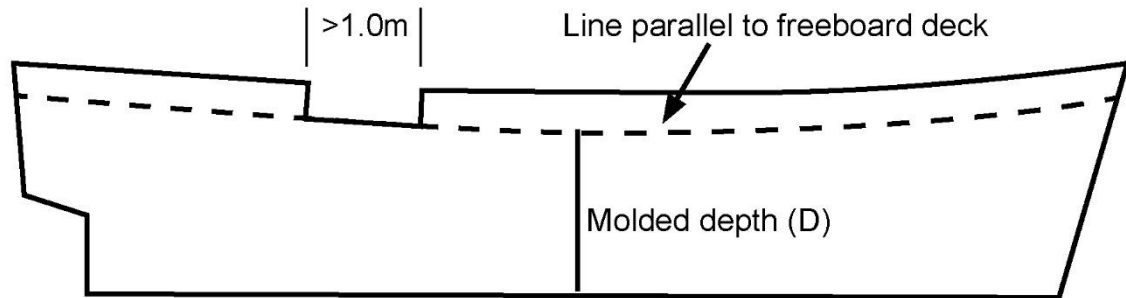
### Schedule 3 Usual method of calculation of freeboard deck that is discontinuous or stepped

(Subparagraph (b)(i) of definition of *freeboard deck* – see dictionary)

- 1 If the freeboard deck is stepped, the lowest line of the deck and the continuation of that line parallel to the upper part of the deck is the freeboard deck.

*Note* For guidance — see Figure 6.

**Figure 6 Freeboard deck that is a discontinuous or stepped deck**



- 2 If the freeboard deck has a recess of  $>1$  m long that extends to the sides of the vessel, the lowest line of the exposed deck and the continuation of that line parallel to the upper part of the deck is the freeboard deck.  
*Note* For guidance — see Figure 6.
- 3 If the freeboard deck has a recess that does not extend to the sides of the vessel, the upper part of the deck is the freeboard deck.
- 4 If the freeboard deck has at least 1 recess not extending from side to side, the recess may be disregarded for the calculation of the freeboard deck if all openings in the weather deck are fitted with weathertight closing appliances.
- 5 Clauses 2 to 4 do not apply to dredgers, hopper barges or other similar types of vessels with large open holds.

## Dictionary

(section 1.9)

**accommodation space** means any of the following areas on a vessel:

- (a) public space;
- (b) a corridor;
- (c) a lavatory;
- (d) a cabin;
- (e) an office;
- (f) a hospital;
- (g) a cinema;
- (h) a game or hobby room;
- (i) a barber shop;
- (j) a pantry that contains no cooking appliances;
- (k) any other space used for leisure or living and not for cargo, storage or the mechanical working of the vessel.

**after part of the hull** means:

- (a) the point of intersection of the trailing edge of the shell plating, planking or other structural material and the upper side of the uppermost weathertight deck; or
- (b) for an open vessel — the point of intersection of the trailing edge of the shell plating, planking or other structural material at the height of the gunwale.

For this definition:

- (a) if the hull has a stern bar or post — the point of intersection lies where the outside of the shell plating or planking meets the stern bar or post; and
- (b) members added to the exterior of the hull are excluded.

*Examples for second paragraph (b)*

fender, sponson, rubbing strip.

*Note* For further guidance about the location of the after part of the hull — see Figure 4 in Schedule 2.

**aftermost part of the hull** means the most aft point of the vessel worked out in accordance with the following:

- (a) members added to the vessel that do not form part of the structure of the vessel are excluded;
- (b) bulwarks are taken to be part of the vessel;
- (c) integrally formed, welded or moulded components and other appendages that provide buoyancy are included in the measurement of length overall;
- (d) areas of deck that are included in the deck area measurement and overhang beyond the extremities of the hull are included in the measurement of length overall.

*Examples for paragraph (a)*

Rudders, outboard motor brackets, non-buoyant swim platforms, fenders, pushpit rails, stern doors or ramp, sponsons, rubbing strip, sternsprits, bumpkins.

*Examples for paragraph (c)*

Integral pods and integral swim platforms.

*Note* For further guidance about the location of the aftermost part of the hull — see Figure 4 in Schedule 2.

**alter**, for a vessel, means to change the vessel so that there is a different level of risk to health or safety, not including a change made because of routine maintenance, repairs or replacement of equipment with identical equipment.

*Note* A vessel might be altered, for example, because of electrical rewiring, machinery alteration, ballast change or alterations to the vessel structure, eg to the hull, bulkheads, decks or superstructure.

**baseline**, for the mainland of Australia, Tasmania and recognised islands off the coast of a State or the Northern Territory, has the same meaning as in the *Sea and Submerged Lands (Territorial Sea Baseline) Proclamation 2006*.

**below deck engine** means an engine that may emanate fuel or fumes that could result in the accumulation of fuel or explosive mixtures in any space on the vessel.

**breadth**, for a vessel, means the maximum breadth of the vessel measured amidships as follows:

- (a) if the vessel has a metal hull — to the moulded line of the frame;
- (b) if the vessel does not have a metal hull — to the outer surface of the hull.

**cargo space** means a space used for cargo, including cargo oil tanks and trunks leading to spaces used for cargo.

**certificate of classification** (or **classification certificate**), for a vessel, means a certificate issued by a recognised organisation that provides that the vessel complies with the recognised organisation's class rules.

**certificate of competency** — see section 6 of the national law.

**certificate of operation** — see section 6 of the national law.

**certificate of survey** — see section 6 of the national law.

**Class 1 vessel** means a vessel that has the vessel use category 1.

**Class 2 vessel** means a vessel that has the vessel use category 2.

**Class 3 vessel** means a vessel that has the vessel use category 3.

**Class 4 vessel** means a vessel that has the vessel use category 4.

**classed vessel** means a vessel for which there is in force a certificate of classification issued by a recognised organisation.

**collared vessel** means a vessel that:

- (a) is fitted with a buoyant collar made up of solid material or hollow sections;  
and
- (b) if it were not fitted in accordance with paragraph (a), would be a rigid inflatable boat.

**control station** means a space where any of the following are located:

- (a) a vessel's radio or main navigating equipment;
- (b) the emergency source of power and emergency switchboard;
- (c) the centralised fire recording or fire control equipment;
- (d) other functions essential to the safe operation of a vessel in normal or emergency conditions.

**crew**, for a vessel, means individuals employed or engaged in any capacity on board the vessel on the business of the vessel, including the master and a pilot.

*Note* This definition differs from the definition of **crew** in the national law. Section 7 of the national law defines **crew** of a vessel as meaning individuals employed or engaged in any capacity on board the vessel on the business of the vessel, *other than* the master of the vessel or a pilot. This definition enables succinct requirements to be set out for a vessel's design, construction, equipment and operation that take into account the total number of persons who must be accommodated on the vessel.

**depth**, for a vessel, means the depth of the vessel calculated in accordance with Schedule 1.

**design waterline** means the waterline corresponding to the maximum operational weight of the vessel with no lift or propulsion machinery active.

**domestic commercial vessel** — see section 7 of the national law.

**extended offshore operations** means vessel operations that are:

- (a) beyond 200 nm seaward from the baseline of any of the following:
  - (i) the Australian mainland;
  - (ii) the Tasmanian mainland;
  - (iii) a recognised island; and
- (b) in waters to the outer limits of the EEZ.

**EEZ** means the exclusive economic zone of Australia.

**EPIRB** means an emergency position indicating radio beacon.

**equivalent length**, for a fast craft, means the equivalent length of the vessel worked out in accordance with the formula mentioned in the definition of the term in section 1.5 of Subsection F1A *General requirements for fast craft*.

**fast craft** (or **high-speed craft**) means:

- (a) a vessel that:
  - (i) is in service category of Class 1A, 1B extended, 1B, 1C, 1D or 1E; and
  - (ii) is able to operate or operates at a speed of at least 25 knots; or
- (b) a vessel that:
  - (i) is in service category of Class 2A, 2B extended, 2B, 2C or 2C restricted; and
  - (ii) is at least  $\geq 35$  m equivalent length; and
  - (iii) is able to operate or operates at a speed of at least 25 knots; or
- (c) a vessel that:
  - (i) is in vessel use category 1, 2 or 3; and
  - (ii) is able to operate or operates at a speed of at least 30 knots.

**fishing operations** means:

- (a) farming, taking, catching or capturing fish for trading or manufacturing purposes; or
- (b) processing or carrying the fish that are farmed, taken, caught or captured; or
- (c) activities in support of fishing operations, including:
  - (i) feeding, storage or transport of fish farmed, taken, caught or captured by the fishing vessel; and
  - (ii) provision of food, fuel and other supplies to the fishing vessel while it is engaged in fishing operations; and

- (iii) transport of the crew or special personnel to and from the fishing vessel while it is engaged in fishing operations; and
- (iv) maintenance of fish farms.

For this definition, **fish** includes any living creature of the sea.

*Examples*

Prawns, oysters, crabs, eels, mussels, octopus.

***fishing vessel*** means:

- (a) a vessel that is used for fishing operations; or
- (b) a vessel that:
  - (i) is in the course of construction; and
  - (ii) is intended to be used for fishing operations.

***fore part of the hull*** means:

- (a) the point of intersection of the leading edge of the shell plating, planking or other structural material and the upper side of the uppermost weathertight deck; or
- (b) for an open vessel — the point of intersection of the leading edge of the shell plating, planking or other structural material at the height of the gunwale.

For this definition:

- (a) if the hull has a bar stem or stem post — the point of intersection lies where the outside of the shell plating or planking meets the stem bar or post; and
- (b) members added to the exterior of the hull are excluded.

*Examples for second paragraph (b)*

fender, sponson, rubbing strip.

*Note* For further guidance about the fore part of the hull — see Figure 5 in Schedule 2.

***foremost part of the hull*** means the most forward point of the vessel worked out in accordance with the following:

- (a) any member added to the vessel that does not form part of the structure of the vessel is excluded;
- (b) a bulwark is taken to be part of the vessel;
- (c) any integrally formed, welded or moulded component or other appendage that provides buoyancy is included in the measurement of length overall;
- (d) any integrally formed bowsprit, pulpit or other similar structure may be excluded if the total width of the structure is not more than 30% of the total breadth of the vessel hull or hulls;
- (e) any area of deck that is included in the deck area measurement and overhangs beyond the extremities of the hull is included in the measurement of length overall.

*Examples for paragraph (a)*

Fenders, pulpit rails, bow doors and ramps, sponsons, rubbing strips and bumpkins.

*Example for paragraph (c)*

Integral long-line fishing platforms.

*Note* For further guidance about the location of the foremost part of the hull — see Figure 5 in Schedule 2.

**freeboard deck**, for a vessel, means:

- (a) the uppermost complete deck of the vessel:
  - (i) that is exposed to weather and sea; and
  - (ii) that has permanent means of closing all openings in its exposed part to maintain weathertight integrity; and
  - (iii) below which all openings in the sides of the vessel are fitted with permanent means of watertight closing; and
  - (iv) that is of a structural strength to withstand the sea and weather conditions likely to be encountered in the intended area of operation of the vessel; or
- (b) if the uppermost complete deck of the vessel that is exposed to weather and sea is discontinuous or has a recess of more than 1 m long that extends to the sides of the vessel:
  - (i) the lowest line of the exposed deck and the continuation of that line parallel to the upper part of the deck; or
  - (ii) for a vessel for which the intact stability criteria mentioned in Chapter 7 of Subsection C6A — *Intact stability requirements* is used — the geometric freeboard determined in accordance with Annex L to Subsection C6C — *Stability tests and stability information*.

*Note for subparagraph (b)(i)* See Figure 6 in Schedule 3 for guidance.

**Great Barrier Reef Region** has the meaning given in subsection 3(1) of the *Great Barrier Reef Marine Park Act 1975*.

**gross tonnage** (or **GT**), for a vessel, means the gross tonnage worked out:

- (a) under regulation 3 of Annex 1 to the Tonnage Convention; or
- (b) in accordance with the formula mentioned in section 3.5.

**hazard** means a source of potential harm.

**height of gunwale** means the vertical distance from the weather deck to the edge of the fore and aft member fitted around the inside of the vessel at the top of the side shell plating, planking or other structural material.

**hire and drive vessel** — see section 6 of the national law.

**HSC Code** means the *International Code of Safety for High-Speed Craft, 2000*, adopted and published by the IMO, as in force from time to time.

**increased level of risk**, for a vessel's operations — see section 13 of *Marine Safety (Domestic Commercial Vessel) National Law Regulation 2013*.

**inflatable boat** has the meaning given by section 3.1 of ISO 6185-1:2001 *Inflatable boats — Part 1: Boats with a maximum power rating of 4.5 kW*.

**initial survey** means the process by which a vessel is inspected for the first time to determine if it meets the requirements of the NSCV or other standards that apply to the vessel under *Marine Order 503 (Certificates of survey — national law) 2013*.

**inland waters** means non-tidal waters.

**inshore operations** means operations of a vessel that are conducted laterally along the coast from either the base or a regular port of departure of the vessel that is within 15 nm to seaward from:

- (a) the baseline of any of the following:
  - (i) the Australian mainland;

- (ii) the Tasmanian mainland;
- (ii) a recognised island; or
- (b) sheltered waters limits.

**ISO** means the International Organization for Standardization.

**length on deck** (or  $L_D$ ) means the distance from the fore part of the hull to the after part of the hull, measured parallel to the design waterline.

**length overall** ( or  $L_{OA}$  ) means the distance measured parallel to the design waterline from the foremost part of the hull to the aftermost part of the hull, excluding appendages.

**lifejacket** means a garment or device that, when correctly worn and used in water, keeps the wearer buoyant.

*Note* A lifejacket is often referred to as a PFD (or personal flotation device).

**long**, for a vessel, means the measured length of the vessel.

**marine incident** — see section 6 of the national law.

**master** — see section 6 of the national law.

**maximum speed**, for a vessel, means the speed achieved by the vessel in smooth water while it is operating at its maximum operational weight and powered by its main propulsion machinery operating at the maximum continuous propulsion power for which the machinery is rated.

**measured length** (or  $L_m$ ), for a vessel, means the length of the vessel calculated in accordance with Schedule 2.

**national law** means the Marine Safety (Domestic Commercial Vessel) National Law set out in Schedule 1 to the National Law Act.

*Note* Under the definition of **this Law** in the national law, the national law includes legislative instruments made under the national law.

**National Law Act** means the *Marine Safety (Domestic Commercial Vessel) National Law Act 2012*.

**national law certificate** — see section 6 of the national law, meaning of **certificate**.

**National Regulator** means the National Marine Safety Regulator — see section 9 of the national law.

**Navigation Act** means the *Navigation Act 2012*.

**non-integral air chamber** means a sealed airtight flotation chamber in a vessel that has no hull surface forming part of its structure.

**non-passenger vessel** means a vessel that is not any of the following:

- (a) a passenger vessel;
- (b) a fishing vessel;
- (c) a hire and drive vessel.

*Note* A non-passenger vessel may carry up to 12 passengers — see definition of *passenger vessel*.

**novel vessel** — see section 3.2.

**NSCV** — see section 6 of the national law, meaning of **National Standard for Commercial Vessels**.

**offshore operations** means vessel operations that are:

- (a) within 200 nm seaward of the baseline of:

- (i) the Australian mainland; or
  - (ii) the Tasmanian mainland; or
  - (ii) a recognised island; and
- (b) in waters to the outer limits of the EEZ.

**open vessel** means a vessel that is:

- (a) not fitted with a watertight weather deck; or
- (b) fitted with a watertight weather deck over part of its length; or
- (c) fitted with a watertight weather deck over the whole of its length and has freeboard to the deck that does not meet the minimum amount required by the NSCV.

*Examples*

- A rowing boat with open bottom boards
- A half-cabin boat with a cockpit or well aft fitted with loose deck panels.

**operate** — see section 6 of the national law.

**operational area**, for a vessel, means the geographical area in which the vessel may be operated.

**owner** — see section 6 of the national law.

**Part B** means *Part B — General requirements* of the NSCV.

**partially smooth waters** means waters that are designated as partially smooth waters under a law in force in a State or Territory.

**partially smooth waters operations** means vessel operations in partially smooth waters.

**passenger**, for a vessel, means any person other than:

- (a) the master or a member of the crew; or
- (b) special personnel; or
- (c) a child not more than 1 year old; or
- (d) a person on board the vessel because of the master's obligation to carry shipwrecked or distressed persons or because of circumstances the master or owner could not prevent.

**passenger vessel** means a vessel that carries or is certified to carry more than 12 passengers.

**pilot** — see section 6 of the national law.

**Protected Zone** — see section 14 of the Navigation Act.

**recognised island** means an island that is:

- (a) part of a State or Territory; and
- (b) mentioned as a recognised island in the list of State or Territory islands determined by the National Regulator for this definition.

*Note* The list of State or Territory islands is available on the AMSA website at <http://www.amsa.gov.au>.

**recognised organisation** — see section 14 of the Navigation Act.

*Note* For organisations that have been prescribed for the definition — see *Marine Order 1 (Administration) 2013*.

**regulated Australian vessel** — see section 6 of the national law.

**rescue boat** means a vessel designed to rescue persons in distress and to marshal survival craft.



**restricted offshore operations** means vessel operations, not beyond the outer limits of the EEZ, within any of the following:

- (a) 30 nm seaward of the baseline of:
  - (i) the Australian mainland other than Queensland; or
  - (ii) the Tasmanian mainland; or
  - (iii) a recognised island;
- (b) the Great Barrier Reef Region or the Torres Strait zone;
- (c) 50 nm seaward from the baseline of the mainland of Queensland;
- (d) 30 nm from the parent vessel of the vessel.

*Note for paragraph (d)* See section 2.8.

**restricted offshore operations — specified areas** means vessel operations in:

- (a) smooth waters; or
- (b) partially smooth waters; or
- (c) a specified area determined by the National Regulator for subsection 2.4 (4).

**rigid inflatable boat** (or **RIB**) has the meaning given by section 3.2 of *ISO 6185-1:2001 Inflatable boats – Part 1: Boats with a maximum power rating of 4.5 kw*.

**risk** has the meaning given by section 2.1 of AS/NZS ISO 31000:2009 *Risk management – Principles and guidelines*.

**risk assessment** has the meaning given by section 2.14 of AS/NZS ISO 31000:2009 *Risk management – Principles and guidelines*.

**sailing vessel** means a vessel designed for and capable of undertaking a voyage when propelled by sail alone.

**seagoing operational area** means any of the following operational areas:

- (a) unlimited domestic operations;
- (b) extended offshore operations;
- (c) offshore operations;
- (d) restricted offshore operations;
- (e) restricted offshore operations — specified areas.

**service category**, for a vessel, means the service category assigned to a vessel under section 2.4.

**sheltered waters** means waters comprising designated smooth or partially smooth waters.

**sheltered waters operational area** means either of the following operational areas:

- (a) partially smooth water operations;
- (b) smooth water operations.

**shore base**, for a vessel, means an area on shore or land that has services, including communication and rescue services and medical or first aid facilities, that can support the operations of the vessel including its launching and retrieval.

**significant wave height** means the mean value of the highest one-third of wave heights measured from trough to crest as recorded in wave time history.

**smooth waters** means waters that are designated as smooth waters under a law in force in a State or Territory.

**smooth waters operations** means vessel operations in smooth waters.

**SOLAS** has the same meaning as **Safety Convention** in section 14 of the Navigation Act.

**special personnel**, for a vessel, means a person who is:

- (a) all of the following:
  - (i) not the master, a pilot or a member of the crew;
  - (ii) not a passenger of the vessel;
  - (iii) on the vessel to perform or assist the performance of the special work being carried out on board the vessel; or
- (b) an observer, trainee, person being coached or a coach; or
- (c) employed by or a volunteer for an emergency services organisation.

**special purpose vessel** means a non-passenger vessel that, because of its purpose, carries on board:

- (a) at least 13 special personnel; or
- (b) at least 13 special personnel or passengers of whom:
  - (i) at least 1 is special personnel; and
  - (ii) not more than 12 are passengers.

**special vessel** means a vessel that is any of the following:

- (a) a novel vessel;
- (b) a hire and drive vessel;
- (c) a fast craft;
- (d) a special purpose vessel.

**STCW Convention** — see section 14 of the Navigation Act.

**superstructure**, for a vessel, means any of the following:

- (a) a structure on the deck of the vessel that extends from 1 side of the vessel to the other side;
- (b) a raised quarter deck on the freeboard deck of the vessel;
- (c) a structure on the deck of the vessel that has side plating not inboard of the shell plating by more than 4% of the breadth of the vessel;
- (d) for a vessel with a lower deck designated as the freeboard deck of the vessel — any part of the hull that extends above the deck.

**superstructure deck** means a deck forming the upper boundary of a superstructure of a vessel.

**tanker** means a cargo vessel constructed or adapted for the carriage of bulk fluid cargoes.

**tender** means a vessel that:

- (a) is used:
  - (i) to transport goods or up to 12 people; or
  - (ii) for a purpose associated with its parent vessel's operation; and
- (b) is not powered by a petrol below deck engine; and
- (c) operates:

- (i) in line of sight of its parent vessel or another distance approved in writing by the National Regulator; or
- (ii) in a marina or a mooring area; and
- (d) is <7.5 m long or another length approved in writing by the National Regulator; and
- (e) if it has a parent vessel — is no longer than its parent vessel.

For this definition a **mooring area** is an area outside a marina that is determined under waterways management legislation to be an area for the mooring of vessels.

*Note* A tender is also known as an auxiliary.

**Tonnage Convention**— see section 14 of the Navigation Act.

**Torres Strait zone** has the same meaning as in Schedule 14 of the *Transport Operations (Marine Safety) Regulation 2004* (Qld).

**unlimited domestic operations** means all domestic operations greater than 200 nm to seaward of the coast.

**unmanned machinery space** means an enclosed propulsion machinery space that under normal operating conditions is not occupied or is intermittently occupied.

**USL Code** means the Uniform Shipping Laws Code adopted by the Australian Transport Council established by the Council of Australian Governments.

**vessel** means a domestic commercial vessel.

**weather deck** means the main deck of a vessel that is exposed to the weather.

**weathertight**, for a vessel, means that in any sea conditions water will not penetrate into the vessel.

---