

NATIONAL SEARCH & RESCUE MANUAL

February 2023 Edition



Australian Government
Australian Maritime Safety Authority



Published by the Australian Maritime Safety Authority (AMSA) on behalf of the Australian National Search and Rescue Council

Written and amended by Senior Sergeant Jim Whitehead, Queensland Police Service.

© This publication is copyright. The reproduction of this work in whole or in part is invited for search and rescue purposes other than commercial purposes provided due acknowledgment is given to the Australian National Search and Rescue Council.

For further information contact the Council Secretariat at:

Secretariat

National Search and Rescue Council

GPO Box 2181

Canberra ACT 2601

2023 EDITION Version 1 – February 2023



Foreword

Search and Rescue (SAR) is the search for and provision of lifesaving assistance to people in distress and imminent danger of loss of life. Australian SAR arrangements are intended to complement other emergency services (police, fire, ambulance) in circumstances where those services are unable to operate effectively. Such circumstances could include, for example, remote area operations, rescues at sea, and the need for specialist SAR facilities not normally available to emergency services.

Depending upon the extent and complexity of the incident and on the available staff and facilities, SAR may take many forms in response to a distress situation. Unless the action is indivisible from that of safeguarding life, a SAR operation does not, however, include salvage or the saving of property.

The Australian search and rescue region covers the Australian continent and large areas of the Indian, Pacific and Southern Oceans as well the Australian Antarctic territories. This is an area of about 52.8 million square kilometres, or about one tenth of the earth's surface. Dedicated SAR assets are limited in Australia and other government, private and commercial assets may be diverted from their primary function by charter, arrangement and request.

In practice, many SAR operations are conducted jointly by Commonwealth and State / Territory authorities. It is, therefore, essential that the available resources and operational techniques are standardised and coordinated across the Australian region.

All SAR authorities in Australia: Australian Maritime Safety Authority, Australian Defence Force and State, Territory and Federal Police must be able to act cooperatively.

In 2017, the Commonwealth, State and Territory Ministers responsible for search and rescue response in Australia updated the Intergovernmental Agreement (IGA) on National Search and Rescue Response Arrangements. The IGA (Appendix A of this Manual) confirmed the National Search and Rescue Council's role as the national coordinating body for search and rescue procedures with a function, among others, of sponsoring this National Search and Rescue Manual.

Documenting standardised techniques and procedures, the National Search and Rescue manual enables SAR authorities to cooperate and coordinate to best effect. By establishing and standardising procedures, the manual seeks to promote effective saving of lives.

Mark Morrow

Chairman

National Search Rescue Council

Australian Maritime Safety Authority

First published in Australia in 1992 by the Australian Maritime Safety Authority (AMSA) on behalf of the Australian National Search and Rescue Council.
82 Northbourne Avenue, Braddon, ACT, 2612, Australia

Written and amended by Senior Sergeant Jim Whitehead, Queensland Police Service on behalf of the National Search and Rescue Council.

Copyright © 2021

Australian Maritime Safety Authority (AMSA) on behalf of the Australian National Search and Rescue Council.

The reproduction of this work in whole or in part is invited for search and rescue purposes other than commercial purposes provided due acknowledgment is given to the Australian National Search and Rescue Council.



A catalogue record for this book is available from the National Library of Australia

ISSN: 2653-2085 (Online)

For further information contact the Council Secretariat at:

Secretariat
National Search and Rescue Council
GPO Box 2181
Canberra ACT 2601

Introduction

This National Search and Rescue Manual is the result of the recent merger of the aviation, maritime and land search and rescue (SAR) manuals and is the standard reference document for use by all Australian SAR authorities. It is promulgated by the National SAR Council operating under direction from relevant Commonwealth, State and Territory Ministers. The Manual promulgates SAR coordination procedures for SAR operations conducted within Australia and the Australian SAR Region (SRR).

The manual is consistent with the relevant International Conventions to which Australia is a party and is supplemented by various legal, informative and instructional documents used within, and between, organisations concerned with search and rescue. It has been developed with due regard to the International Aviation and Maritime Search and Rescue Manual (IAMSAR).

The National SAR Manual meets the requirements of international conventions for an Australian Search and Rescue Plan, and includes material covering:

- a) Abbreviations, terminology and definitions relevant to SAR practitioners
- b) The elements and functions of the Australian SAR system
- c) Details of communications, assets and procedures for coordination
- d) SAR planning and techniques including worksheets

The National Search and Rescue Manual acts as a set of procedures and guidelines in providing a search and rescue response within Australia. It is understood that the knowledge and experience of officers can extend beyond what is covered within this manual and therefore initiative should be used accordingly in search and rescue operations. It is however, necessary to follow the guidelines outlined within this manual as closely related to the circumstances presented and keep all relevant parties well informed throughout the process. Officers should be prepared to justify their actions if necessary. When developing Standard Operating Procedures (SOP) at the organisational level, care should be taken to ensure that procedures are written consistent with the National SAR Manual. Should an SOP be identified that may be of benefit to the wider SAR community, it is recommended that the issue be raised with the National SAR Council so that inclusion of the procedure into the National SAR Manual can be considered.

This manual is under continual review and will be updated as necessary. The National SAR Manual is promulgated online for the use of all search and rescue practitioners. The Internet version is the controlled document and is the latest version of this manual. The online version should always be referred to as it contains the most up to date information.

Suggestions and questions regarding this Manual should be forwarded to:

The Secretariat of the National SAR Council

Australian Maritime Safety Authority
GPO Box 2181
Canberra ACT 2601

Defence Letter of Promulgation

UNCLASSIFIED



CHIEF OF JOINT OPERATIONS

Headquarters Joint Operations Command

AM3290753

Mr Toby Stone

Chairman, National Search and Rescue Council
Australian Maritime Safety Authority

Dear Mr Stone,

ADF ENDORSEMENT OF THE NATIONAL SEARCH AND RESCUE MANUAL

The Australian Defence Force (ADF) has a long and proud history of conducting Search and Rescue (SAR) operations in support of the civil community. Through our long-running involvement with the National SAR Council, we are fortunate to have developed highly effective relationships with both the Australian Maritime Safety Authority, and the State and Territory police forces. As a previous Commander of [then] Border Protection Command, I have witnessed first-hand the expertise and dedication of Australian SAR professionals under the most challenging circumstances.

The SAR mission is one of utmost importance to the Soldiers, Sailors and Airmen of the ADF. As their Operational Commander I remain committed to the provision of military support if and when it is required. I commend you on the continued success of the National SAR Council and on the proficient realisation of the National SAR Plan. Further, I recognise the high quality of the National SAR (NATSAR) Manual and the important role it plays in coordinating inter-departmental operations. The NATSAR Manual is an authoritative instruction on SAR best practice, and as such I have directed that it be accepted by the ADF as the standard procedural guide for the conduct of ADF SAR operations.

Yours sincerely,

DL Johnston, AM
Vice Admiral, RAN
Chief of Joint Operations
Details
AC

B1-1-J001
Department of Defence
PO BOX 7928
CANBERRA ACT 2610
(02) 6128 4000, fax (02) 6128 4020

21 December 2017

Table of Contents

Contents

Foreword	1
Introduction.....	3
Defence Letter of Promulgation	4
Table of Contents	5
Index	21
Acronyms and Abbreviations	27
Glossary	34
Volume 1 - Search and Rescue Administration	
Chapter 1 SAR System Organisation.....	43
1.1 Organisation	43
Global SAR System Organisation	43
National and Regional SAR System Organisation	43
Australian Maritime Safety Authority (AMSA)	44
State and Territory Governments.....	45
Australian Defence Force Responsibilities – Military SAR.....	46
Headquarters Joint Operations Command.....	46
Airservices Australia	46
Other Commonwealth Agencies/Authorities	47
Bureau of Meteorology (BOM).....	47
Emergency Management Australia (EMA)	47
Maritime Border Command	47
Australian Communications and Media Authority (ACMA)	47
Australian Transport Safety Bureau (ATSB).....	47
Civil Aviation Safety Authority (CASA).....	47
Volunteer Organisations.....	47
Commercial and Private Organisations	48
1.2 SAR Coordination.....	48
Overview.....	48
Alerting Post	48
Determination of SAR Authority Responsible for Overall Coordination	48
Initial Response.....	49
SAR Authority Best Placed to Coordinate.....	49

Effective Consultation and Coordination	50
Cooperation with Foreign Rescue Coordination Centres	50
Transfer of Coordination	51
Requesting JRCC Australia Assistance	54
1.3 Requesting State / Territory SAR Authority Assistance	55
Requests for Defence Assistance (DACC)	55
Defence Requests for Civil Assistance	55
1.4 Australian Search and Rescue Region	55
1.5 SRR Coordinates	57
1.6 Australian States and Land Search Area	57
Chapter 2 SAR Management	59
2.1 Overview	59
SAR Authority Responsibilities	59
Forward Command Post	60
RCC/Field Search Headquarters (FSH) Staff	61
Search and Rescue Roles	62
2.2 Search and Rescue Resources	65
Overview	65
Personnel	66
Dropmasters, Dispatchers and Observers	66
Rescue Preparation	67
2.3 Public Relations	67
Overview	67
Operations involving two or more SAR Authorities	67
Public Relations Officers (PRO's)/Media Officers (MO)	68
Press Releases	68
Requesting Public Assistance	69
Liaison with Relatives	69
Notification of Next of Kin	69
Casualties	70
2.4 Other Emergency Assistance and Services available from JRCC Australia	70
General	70
Maritime Safety Information	70
Unlawful Acts	71
Chapter 3 Training and Exercises	72
3.1 Requirements for SAR Training	72

Training	72
Who to Train	72
Requirement for Training	72
3.2 National Training Framework	72
Qualifications	72
Public Safety Training Package; Police Training Package	73
AMSA Training	73
The National Search and Rescue Manager’s Course	73
State/Territory SAR Authority Training	73
3.3 Search and Rescue Exercises	74
3.4 Training of Search and Rescue Assets	74
Land SAR Training	74
Search and Rescue Crew Training	74
Dropmaster and Dispatchers	75
Air Observer Training	75
Aviation Search and Rescue Assets (SRA)	75
First Aid Training	75
Map Reading and Navigation	75
Radio Operating Procedures	76
Field craft	76
Observation Skills	76
Observation Skills-Day	76
Team and Individual Skills	77
Searchers	78
Search Team Leaders/On-Scene Commanders	78
3.5 Photographic Records	79
3.6 Liaison Visits	79
Volume 2 - Search and Rescue Operations	
Chapter 1 Communications	82
1.1 Aviation and Maritime	82
Overview	82
1.2 Distress and Emergency Signals	82
Maritime Radio Alarm Signal	82
Radiotelephone Distress Signal	83
Radiotelephone Urgency Signal	83
Radiotelephone Safety Signal	83

Radiotelephony Distress/Emergency Frequencies.....	83
GMDSS Distress, Urgency, Safety and Calling Frequencies	83
2182 kHz	83
4125, 6215, 8291, 12290 and 16420 kHz	84
121.5 MHz.....	84
156.8 MHz (Marine VHF Channel)	84
243 MHz.....	84
Safety Frequencies	84
1.3 Global Maritime Distress and Safety System (GMDSS)	84
1.4 Emergency Signalling Devices.....	85
Daylight Devices	85
Night Vision Imaging Systems (NVIS) for aviation searching.....	85
RADAR/IFF/SSR	86
Radio and Distress Beacons.....	86
1.5 COSPAS-SARSAT Distress Beacon Detection System.....	86
Overview.....	86
Purpose.....	87
Satellites	87
Beacon Detection	88
Beacons.....	88
1.6 Other Types of Distress Alerting Devices	89
SPOT Personal Satellite Messenger device (SPOT).....	89
AIS-SART	89
Maritime Survivor Locating Systems. VHF DSC Maritime Survivor Locating Devices (MSLD).....	89
Thuraya Satellite Devices.....	90
1.7 SAR RADAR Transponder (SART)	90
Overview.....	90
1.8 Communications in Support of SAR Operations.....	91
Overview.....	91
SAR Frequencies	91
SAR Call Signs.....	91
1.9 Communications Facilities.....	92
Overview.....	92
Communications Capabilities Australian Defence Force Ships and Aircraft	92
Search and Rescue Visual Signals	93
Merchant Shipping and GMDSS	93

Limited Coast Radio Stations	94
Ship Stations	94
Fishing Vessels	94
Pleasure Craft	94
Volunteer Organisations.....	95
Communication Capabilities of State & Territory SAR Authorities	95
Communications Aircraft.....	95
Inmarsat Aero	96
1.10 Land Search Communications	96
Overview.....	96
1.11 Communications.....	97
1.12 Communications Officer.....	97
1.13 Communication Requirements.....	97
1.14 Headquarter Requirements.....	97
1.15 Telephone/Radio	98
1.16 Rear Net.....	98
1.17 Forward Net.....	98
1.18 Frequencies	98
1.19 Radios in general	99
1.20 Procedures and Practices	100
1.21 Other Methods of Communications.....	100
Chapter 2 Awareness and Initial Action	101
2.1 Awareness Introduction	101
2.2 Types of SAR Incidents.....	101
Maritime SAR Incident.....	102
Aviation SAR Incident	102
Land SAR Incident	103
2.3 Recording of Events.....	103
2.4 SAR Stages	103
2.5 Awareness and Initial Action Stages (Stage 1 and 2).....	104
Types of Notification Reports	104
Evaluation of Notification Reports	105
Information: SAR Incident Information	105
Advising States of Foreign Persons in Distress	108
2.6 Emergency Phases	108
Uncertainty Phase	109

Alert Phase.....	109
Distress Phase.....	110
2.7 Initial Action: Procedures of the Emergency Phases.....	111
Overview.....	111
Uncertainty Phase Initial Action.....	111
Alert Phase Procedures.....	112
Distress Phase Procedures.....	113
2.8 Intelligence Gathering and Assessment.....	114
Overview.....	114
Communication Checks.....	115
Intelligence gathering.....	116
Sighting and Hearing Reports.....	119
Coordination with the Police.....	121
Examination of Recorded Communications - Aircraft and vessels.....	121
Flight Path Analysis - Aircraft.....	121
Weather Analysis.....	122
Logistical Information.....	122
General Considerations for the SMC.....	122
Chapter 3 Search Planning and Evaluation.....	128
3.1 Aviation and Maritime Search Planning.....	128
Overview.....	128
3.2 Aviation and Maritime Search Planning Steps.....	128
Evaluating the Situation.....	129
Estimating the Distress Incident Location.....	129
Datum Considerations.....	130
Drift Considerations.....	130
3.3 Search Response Stages.....	131
Factors Affecting the Search Response Plan.....	131
3.4 Aviation and Maritime Basic Search Planning.....	133
Controlling Factors.....	134
Search Effort Expenditure Rate.....	135
Maximum Search Effort.....	135
Search Sequence.....	135
3.5 Aviation and Maritime Determination of Search Areas.....	137
Aviation and Maritime Planning.....	137
Possibility Area.....	137

Calculation of Circles of Probability.....	140
Probable Errors of Position.....	141
Search Radius (R).....	141
Drift Error for Waterborne Targets	141
Currents	142
Leeway.....	145
Divergence.....	145
Calculating Leeway	145
Plotting Drift	147
Datum Plot.....	147
Drift Error (De).....	148
Search Area Based on Non-Moving Datum	149
Search Based on Moving Datum	149
Labelling the Datum	151
Consideration of Possible Courses of Action by the Captain of the Target.....	152
3.6 Coastal Search Planning.....	152
Search Area.....	152
Position Uncertainty.....	155
Track Line Overdue Incident.....	155
Recomputed Datum	156
Track Spacing.....	158
3.7 Land Search Planning.....	159
Overview.....	159
3.8 Incident Command	159
3.9 Situational Awareness	159
3.10 Conducting an Appreciation.....	160
Definition	160
Sequence	160
Phases.....	160
Aim.....	161
Limitations	161
Written Statement.....	161
Factors	161
Examination.....	161
3.11 Courses Open.....	162
Plan	162

Planning Principles.....	163
Keep it simple	163
Relate to the Aim.....	163
Logical deductions	163
Land Search Planning.....	163
Scenario-based Assessment	164
Factors Influencing Discovery.....	165
Analyse possible land strategies.....	165
Raise land search strategies	165
Identify priority land search area	165
Ongoing reassessment of land search.....	165
Search Urgency Assessment (SUA).....	166
3.12 Terrain Factors.....	166
3.13 Land Environments.....	167
Rainforest	167
Alpine Environment.....	170
Arid Environment.....	172
Mountain Environment	173
Dangerous Animals.....	179
Telephone Triangulation	180
Land Search Planning.....	180
Reflex Search	181
3.14 Formal Search (Land).....	182
Theoretical Search Strategy (Naismith’s Rule)	182
Statistical Strategy (Lost Person Behaviour).....	184
3.15 Subjective/Decision Point Strategy (Land)	186
Decision Points	187
3.16 Deductive Strategy (Land)	189
Using all four Formal Search Strategies.....	189
3.17 Recording of search areas (Land)	198
Behaviour of Lost People.....	205
Mass Casualty SAR Incidents	207
Urban SAR (USAR).....	208
Coordination.....	208
Initial Actions	209
Working under or within a MIR.....	210

MIR Liaison Officer	210
Field Search Headquarters	210
Searching	211
Land Search problems	212
Search Area Delineation	213
Tasking sheets.....	214
Briefings.....	215
Record Keeping.....	216
Passive Searching.....	218
Chapter 4 Search and Rescue Techniques	219
4.1 Aviation and Maritime Search Operations	219
Overview.....	219
4.2 General Guidelines for Searches	219
Stage One Search: Immediate response	219
Stage Two Search: Nominated Area Either Side of Track.....	220
Stage Three Search: Mathematically Derived Area.....	221
4.3 Aviation and Maritime Search Area Coverage	221
General	221
Sweep Width (W): Factors affecting Sweep Width	222
Track Spacing (S).....	227
Coverage Factor (C)	228
Aviation and Maritime Probability of Detection (POD).....	228
4.4 Navigation of SAR Assets (Aviation and Maritime)	230
4.5 Visual Search Patterns (Aviation and Maritime)	231
General	231
Parallel Track Search Pattern.....	232
Creeping Line Patterns	234
Track Line Search.....	234
Expanding Square Search	235
Sector Search.....	237
Aural Search by Surface Craft.....	239
Coastal Search (Islands and their Foreshores)	240
Contour Search by Aircraft	240
Mountainous or Rugged Terrain Searches	243
Line Abreast Helicopter Searches.....	243
Aviation and Maritime Search Considerations.....	243

4.6	Flare Searches.....	244
4.7	Electronic Searches.....	245
	Distress Beacons.....	245
	Maximum Radio Signal Range Calculations.....	248
	Signal Heard, Signal Fade Plotting Method.....	248
	De-tuning Method.....	249
	Hill Shading.....	249
	Locating a Signal from the Ground.....	249
	Search by RADAR.....	250
	Search by Infrared (IR) Devices.....	251
	Night Vision Imaging Systems.....	252
4.8	Aviation and Maritime SAR Asset Selection and Characteristics.....	252
	Overview.....	252
	Aviation Assets.....	253
	Australian Defence Force Aviation Assets.....	255
	Customs and Border Force Aircraft.....	256
	Maritime Assets.....	256
	Naval Vessels.....	257
	Customs Vessels.....	257
	Use of Merchant Shipping.....	257
	Equipment for Marine Craft.....	258
	Land Search Facilities.....	258
4.9	Aviation and Maritime Search Asset Allocation.....	258
	Introduction.....	258
	Aircraft Capability.....	259
	Calculation of Search Time Required.....	259
	Calculation of Search Time Available.....	260
	Investigation Time.....	260
	Effective Search Time.....	261
	Comparison of Search Time Required and Time Available for Search Aircraft.....	261
	Allocation Variations to Suit Particular Aircraft.....	263
	Allocation Chart Presentation.....	263
4.10	SAR Crew Briefing.....	264
	General.....	264
	Search Briefing.....	264
	Search Aircrew Briefing.....	265

Search Aircraft Operations	266
Communications Relay Aircraft	267
Top Cover Aircraft.....	267
Maritime Search Crews	268
Land Assets in Aircraft Search	268
4.11 SAR Crew Debriefing.....	269
Overview.....	269
4.12 Land Search Operations.....	270
Overview.....	270
4.13 Land Search Assets	270
Land Assets	270
Land Search using Maritime Assets	275
Land Search Considerations for Aviation Assets	276
Land Search Action Plan	278
General Search (Land SAR)	281
Contact Search (Land SAR)	281
4.14 Land Search Area Coverage.....	283
Land SAR Target Type.....	284
Land SAR Meteorological Visibility	284
Type of Terrain/Conditions.....	284
Land Search Speed.....	284
Cloud Cover and Sun Light.....	285
Land SAR First and Last Search Light	285
Land SAR Probability of Detection.....	286
Visual Horizon: Ankle Rule (Land SAR)	286
Area Swept (Land SAR)	286
Accuracy of Navigation by Land Search Teams	287
Land SAR Night Searching.....	288
Searching in Hazardous Areas	288
4.15 Land Search Patterns.....	289
Common Land Search Patterns	291
4.16 Clue Recognition and Interpretation.....	303
General Principles.....	303
4.17 Land Search Briefings	305
Preparation.....	306
Mattson Consensus	311

Chapter 5	Rescue Planning Operations	313
5.1	Rescue General.....	313
5.2	Medical Assistance	314
5.3	Aircraft Accidents	314
	Health Hazards.....	314
5.4	Land Rescue	315
	Avoidance of Danger	316
5.5	Maritime Rescue.....	316
	Use of Rescue Boats and Vessels.....	317
	Marking Targets.....	317
5.6	Rescue Assets	317
	Use of Aircraft for Rescue.....	317
	Use of Helicopters for Rescue	318
	Use of Top Cover Aircraft with Rescue and MEDEVAC Helicopters	319
5.7	Supply Dropping and Delivery of Survival Equipment.....	319
	Civil SAR Equipment.....	319
	Supply Drop from Aircraft over Sea.....	320
	Supply Drop from Helicopter over Sea	320
	Supply Drop from Aircraft over Land.....	320
Chapter 6	Conclusion of SAR Operations	321
6.1	Conclusion General.....	321
6.2	Conclusion of a successful SAR operation	321
6.3	Suspension/termination of a search when the target is not found	321
6.4	Reopening a Suspended Search	323
6.5	Records and Reports.....	323
6.6	Incident Debriefs	323
	Conducting the Debrief	325
	Lesson for improvement	325
6.7	Case Studies.....	326
6.8	Peer Reviews	326
Chapter 7	Medical Factors	328
7.1	General	328
7.2	Time Frame for Survival (TFFS).....	328
7.3	Survivor Stress Factors	328
7.4	Survival Environment Factors.....	329
7.5	Hypothermia.....	329

7.6	Water Hypothermia.....	329
7.7	Wind Hypothermia	332
7.8	Wind Chill.....	333
7.9	Hypothermia Survivability	334
7.10	Wet-Chill Survivability	334
7.11	Water Immersion.....	335
7.12	Effects of Alcohol.....	335
7.13	Hyperthermia, Heat Stress and Dehydration	335
7.14	Heat Exhaustion.....	336
7.15	Heat Stroke	337
7.16	Hyperthermia Survivability.....	339
7.17	Terrain Factors.....	341
7.18	Seeking Medical Advice	342
Appendix A – Intergovernmental Agreement		343
Appendix B – National SAR Responsibilities		344
Appendix C – National Operational Procedure for Transfer of Coordination		359
	Guidelines for Procedure to transfer coordination.....	360
	State / Territory SAR Authority Points of Contact.....	361
	Transfer of Coordination Information Exchange Requirements	365
	Overview.....	366
Appendix D-1 Distress Emergency Signals.....		366
	Overview.....	366
	International Distress Signals	366
	Search and Rescue Signals – Australian Area	366
	Civil Air-Ground Code	367
	International SAR Signals.....	368
Appendix D-2 Maritime SAR Recognition Code (MAREC)		369
	Overview.....	369
	Part 1 – Merchant Vessels	370
	Complete example Merchant Ship	375
	Part 2 – Small Craft	376
Appendix D-3 Plotting Symbols		386
Appendix D-4 Sighting and Hearing (SHR) Techniques.....		387
	Listening Techniques	387
	Open Questions	387
	Closed Questions	387

Leading Questions	387
Instructions for Completing Sighting and Hearing Reports.....	388
Sighting and/or Hearing Report for Missing Aircraft.....	389
Sighting and Hearing Report – Generic	390
Sighting and/or Hearing Log	391
Appendix D-5 Tables and Graphs	392
Local Wind Current.....	392
Leeway Tables (kt)	392
Sweep Width Tables For Visual Search Over Water.....	392
Sweep Width Tables For Visual Search Over Land:	392
Probability of Detection.....	392
Local Wind Current.....	393
Leeway Tables.....	394
Taxonomy Class Definitions/Descriptions	395
Probability of Detection.....	403
Sweep Width Tables for Visual Search over Water	404
Weather Correction Factors for all Types of Search Facilities.....	405
Uncorrected Visual Sweep Widths for Merchant Ships (NM)	405
Uncorrected Sweep Widths for Fixed-Wing Aircraft (NM) at 500 ft and 1000 ft.....	406
Weather Correction Factors for all Types of Search Facilities.....	407
Uncorrected Sweep Widths for Fixed-Wing Aircraft (NM) at 1500 ft and 2000 ft.....	408
Weather Correction Factors for all Types of Search Facilities.....	409
Uncorrected Sweep Widths for Helicopters (NM) – Maritime 500 ft and 1000 ft.....	409
Weather correction factors for all types of search facilities	410
Uncorrected Sweep Widths for Helicopters (NM) - Maritime 1500 ft and 2000 ft	411
Weather correction factors for all types of search facilities	412
Fixed-wing Aircraft Search Facilities.....	413
Sweep Width Tables for Visual Search Over Land.....	414
Correction Factors – Vegetation and High Terrain.....	414
Appendix D-6 Probable Errors of Position.....	415
Probable Navigation Error of the Target (x)	415
Probable Navigation error of the Search Craft (y).....	416
Appendix D-7 Maritime and Aviation Worksheets.....	418
Overview.....	418
Worksheet 1: Maritime Planning	419
Worksheet 2 – Maritime Search by Aircraft.....	420

Worksheet 3 – Land Search by Aircraft	421
Worksheet 4 – Search Radius	422
Worksheet 5 – Sector Search	423
Worksheet 6 – Aircraft Allocation	424
Worksheet 7 – Asset Allocation.....	425
Worksheet 8 – Maritime Search by Vessel.....	426
Appendix D-8 Aircraft Accident Site Precautions	427
Safety Precautions and Procedures at Aircraft Accidents	427
Appendix D-9 Civil Aircraft Search and Rescue Assets (SRAs)	428
AMSA Aircraft Tier SRA Capability Definitions	428
Tier 1 SRAs	428
Opportunity Based SAR Services	429
Current Aircraft and Police Fixed-Wing Operators.....	430
Air Search Observer Programme	430
Air Search Equipment	430
Locations of Tier 1, 2 Assets	430
Appendix D-10 Coastal Datum Search and Rescue Planning	432
A Step-By-Step Guide for SAR Trained Personnel	432
Vessel Adrift.....	432
Step-By-Step Guide.....	433
Position Uncertainty	438
Step-By-Step Guide.....	483
Time Uncertainty	441
Step-By-Step Guide.....	442
Track Line Overdue.....	446
Step-By-Step Guide.....	447
Multiple Winds	454
Step-By-Step Guide.....	455
Multiple Current and Winds	457
Step-By-Step Guide.....	457
Overview.....	460
Appendix E-1 Search Urgency Assessment Form	461
Appendix E-2 Missing Person Questionnaire	462
Appendix E-3 Object Questionnaire	463
Appendix E-4 Land SAR Checklist	464
Appendix E-5 Lost Person Behaviour.....	468

Appendix E-6 Land Search Planning Tables	485
Land Search Planning Tables	485
Land Search Area Quick Reference.....	486
Land Air Search Planning Table	486
Vegetation Correction Factor (Ve).....	486
Appendix E-7 Additions to Naismith’s Rule	488
Appendix E-8 Land SAR Probability of Detection (Land)	489
Appendix E-9 Mattson Consensus.....	494
Appendix E-10 Land Search Organisation Chart Example	495
Appendix E-11 Field Search Headquarters Layout Example.....	496
Appendix E-12 Search Communications Network Example	497
Appendix E-13 Clue Recognition	498
Appendix E-14 SAR Tasking Sheet Example.....	500
Appendix E-15 Search for Skeletal Remains.....	501
Bone characteristics.	502
Plant growth on bones	505
Predator damage to bones.....	507
Appendix E-16 Peer Review Form Example.....	508
Appendix E-17 Body Flotation Information	510
Appendix F - Aircraft Electronic Night Search Guidance	512

Index

121.5 MHz.....	82	Aviation Assets.....	250
156.8 MHz (Marine VHF Channel 16).....	82	Aviation and Marine Basic Search Planning	133
2182 kHz.....	81	Aviation and Marine Determination of Search Areas	136
243 MHz.....	82	Aviation and Marine Planning	133
4125, 6215, 8291, 12290 and 16420 kHz	82	Aviation and Maritime Probability of Detection (POD).....	226
Accepting Coordination for a Component of the SAR Event from another SAR Authority.....	52	Aviation and Maritime Search Planning Steps	127
Accuracy of Navigation by Land Search Teams	283	Aviation and Maritime Communications.....	80
Actions by JRCC Australia	116	Aviation and Maritime SAR Asset Selection and Characteristics	249
Additional considerations for Search Dogs	270	Aviation and Maritime Search Area Coverage..	219
Advising States of Foreign Persons in Distress .	108	Aviation and Maritime Search Asset Allocation	255
Air Observer Training.....	75	Aviation and Maritime Search Considerations	241
Air Wings/State and Community provided aerial assets Communications	93	Aviation and Maritime Search Operations	217
Air, Marine or Land Incident Information	106	Aviation and Maritime Search Planning	127
Aircraft Accidents	308	Aviation Capability.....	54
Aircraft Capability.....	255	Aviation SAR Incident	102
Aircraft Incidents	132	Aviation Search and Rescue Units (SRU)	75
Airservices Australia	46	Avoidance of Danger	310
AIS-SART	87	Awareness and Initial Action	101
Alert Phase.....	109	Awareness and Initial Action Stages (Stage 1 and 2).....	104
Alert Phase Procedures	112	Awareness Introduction	101
Alert Phase Transition	113	Barrier	289
Alerting Post	48	Beacon Detection	85
All Other Requests for Defence SAR Assistance.	55	Beacon Search Procedures	244
Allocation Chart Presentation	260	Beacon Transmission Characteristics	243
Allocation Variations to Suit Particular Aircraft	259	Beacon Types	243
Allocator/Planner	64	Beacons.....	86
Alpine Environment.....	168	Behaviour of Lost People	203
Area Swept	283	Bone Characteristics	494
Arid Environment	170	Briefing Officer.....	64
Assessing Reports	120	Briefings	54, 212
Assistant SAR Mission Coordinator (A/SMC) Responsibilities and Duties.....	64	Bureau of Meteorology (BOM).....	47
Aural Location of Beacons	245	Calculated Search Area	278
Aural Search by Surface Craft.....	237	Calculating Leeway	144
Australian Communications and Media Authority (ACMA)	47	Calculation of Circles of Probability.....	139
Australian Defence Force Aviation Assets	252	Calculation of Search Time Available.....	256
Control of ADF Aircraft	252	Calculation of Search Time Required.....	256
Australian Defence Force Responsibilities – Military SAR	46	Case Studies.....	319
Australian Maritime Safety Authority (AMSA) ...	44	Casualties.....	70
Australian Search and Rescue Region	55	Civil Aviation Safety Authority (CASA)	47
Australian States and Land Search Area.....	57	Civil SAR Equipment.....	313
Australian Transport Safety Bureau (ATSB).....	47	Cloud Cover.....	223
Available Search Asset Factors	125	Cloud Cover and Sun Light.....	281

Clue Recognition and Interpretation.....	298	Creeping Line Ahead.....	292
Clue Time Sequence.....	299	Creeping Line Patterns.....	232
Clues or Messages.....	299	Currents.....	141
Coastal Search (Islands and their Foreshores).....	237	Customs and Border Force Aircraft.....	253
Coastal Search Planning.....	150	Customs Vessels.....	254
Command/Communications Caravans.....	93	Dangerous Animals.....	177
Commercial and Private Organisations.....	48	Datum Considerations.....	129
Common Land Search Patterns.....	286	Datum Plot.....	146
Communication Capabilities of State & Territory		Day and Night Factors.....	224
SAR Authorities.....	93	Daylight Devices.....	83
Communication Checks.....	115	Daylight Factor.....	123
Communication Checks for Marine Craft.....	115	Decision Points.....	185
Communication Requirements.....	95	Deductive Strategy.....	186
Communication Search.....	111	Defence Requests for Civil Assistance.....	55
Communications.....	92	De-tuning Method.....	246
Communications Aircraft.....	93	Distress Alerts.....	104
Communications Capabilities Australian Defence		Distress and Emergency Signals.....	80
Force Ships and Aircraft.....	90	Distress Beacons.....	242
Communications Checks for Aircraft.....	115	Distress Phase.....	110
Communications Facilities.....	89	Distress Phase Procedures.....	113
Communications in Support of SAR Operations.....	88	Distress Phase Transition.....	112
Communications Officer.....	95	Divergence.....	144
Communications Relay Aircraft.....	263	Drift Compensation.....	241
Comparison of Search Time Required and Time		Drift Considerations.....	129
Available for Search Aircraft.....	258	Drift Error (De).....	147
Composition of Contact Search Teams.....	278	Drift Error for Waterborne Targets.....	140
Conclusion General.....	315	Dropmaster and Dispatchers.....	75
Conclusion of a successful SAR operation.....	315	Dropmasters, Dispatchers and Observers.....	66
Conclusion of SAR Operations.....	315	Echelon Pattern.....	296
Conducting an Appreciation.....	159	Effective Consultation and Coordination.....	50
Conducting the Debrief.....	318	Effective Search Time.....	257
Consideration of Possible Courses of Action by		Effects of Alcohol.....	329
the Captain of the Distress Craft.....	150	Electronic Searches.....	242
Considerations for Aviation Assets.....	272	Emergency Management Australia (EMA).....	47
Contact Search.....	278	Emergency Phases.....	108
Contact Search Considerations.....	278	Emergency Signalling Devices.....	83
Contour Search by Aircraft.....	238	Equipment for Marine Craft.....	254
Contour Search by foot.....	294	Estimating the Distress Incident Location.....	128
Control of ADF Aircraft.....	252	Evaluating the Situation.....	128
Controlling Factors.....	133	Evaluation of Notification Reports.....	105
Cooperation with Foreign Rescue Coordination		Evidentiary Searches.....	214
Centres.....	50	Examination of Recorded Communications -	
Coordination.....	206	Aircraft and vessels.....	121
Coordination Principles with Foreign RCCs.....	50	Execution Factors.....	213
Coordination with the Police.....	121	Expanding Square.....	294
COSPAS-SARSAT		Expanding Square Search.....	233
MEOSAR.....	84	Explanatory terms.....	269
COSPAS-SARSAT Distress Beacon Detection		Factors Affecting the Search Response Plan ...	130
System.....	84	Fast/Reconnaissance Search.....	276
Courses Open.....	161	Fatigue Factor.....	222
Coverage Factor (C).....	226	Field craft.....	76
Crashed Aircraft Communication Checks.....	116	Field Search Headquarters.....	208

First Aid Training.....	75	Intelligence Officer	64
First and last search light.....	123	International Distress Frequencies - Guarded by Royal Australian Naval Ships.....	90
First Search Light/Last Search Light.....	224	Interviewing Witnesses.....	120
Fishing Vessels	92	Introduction	255
Flare Searches.....	242	Investigation Time	257
Flight Path Analysis - Aircraft.....	121	Irregularly Shaped Areas.....	241
Forensic Searching.....	175	JRCC Responsibilities	44
Formal Search.....	180	Labelling the Datum.....	149
Forward Command Post.....	60	Land Assets	267
Forward Net.....	96	Land Assets in Aircraft Search	265
Frequencies	96	Land Environments.....	166
Fungal Growth on bones	499	Land Operations	
General	70	General Search Method	277
General - Communication Checks	115	Land SAR Additional Aircraft.....	274
General Considerations	157	Land SAR First and Last Search Light	281
General Considerations for the SMC.....	122	Land SAR Incident	102
General Guidelines for Searches	217	Land SAR Meteorological Visibility	280
General Search	277	Land SAR Night Searching.....	284
General Time Factors.....	123	Land SAR Probability of Detection.....	282
Geographical Coordinates	261	Land SAR Resources.....	175
Global Maritime Distress and Safety System (GMDSS).....	82	Land SAR Target Type	280
Global SAR System Organisation	43	Land SAR Training	74
GMDSS Distress, Urgency, Safety and Calling Frequencies	81	Land Search Action Plan	274
Good Search Conditions	156	Land Search and Rescue Units (SRU)	272
Guidance in Support of Transferring Coordination of a Component of a SAR Operation	52	Land Search Area Coverage	279
Headquarter Requirements.....	95	Land Search Assets	267
Headquarters Joint Operations Command.....	46	Land Search Briefings.....	300
Health Hazards	308	Land Search Communications	94
Health Hazards - Aircraft Accidents.....	116	Land Search Considerations for Aviation Assets	272
Heat Exhaustion.....	329	Land Search Facilities.....	255
Heat Stroke	330	Land Search Helicopters	274
Hill Shading	246	Land Search Operations.....	266
Hyperthermia Survivability.....	330	Land Search Patterns	285
Hyperthermia, Heat Stress and Dehydration ...	329	Land Search Planning.....	162, 179
Hypothermia.....	323	Land Search Private aircraft.....	274
Hypothermia Survivability	327	Land Search problems	210
Immediate Response	275	Land Search Seaplanes	274
Incident Command	157	Land Search Speed.....	280
Incident Debriefs	317	Land Search using Maritime Assets	272
Information: SAR Incident Information	105	Landmarks.....	262
Initial Action: Procedures of the Emergency Phases.....	110	Leeway	144
Initial Actions	207	Lesson for improvement.....	319
Initial Response	49	Liaison Officer	65
Initial Search Procedures	131	Liaison Visits.....	79
Inmarsat Aero	93	Liaison with Relatives	69
Insufficient Search Time	259	Limited Coast Radio Stations	91
Intelligence gathering.....	116	Line Abreast Helicopter Searches.....	241
Intelligence Gathering and Assessment	114	Lines of Communications - NAVY	91
		Local Wind Current	143
		Localised Emergency Assistance to Save Life	55

Locating a Beacon Signal Source by Homing Devices.....	245	Observation Skills-Day	76
Locating a Signal from the Ground	246	On Scene Coordinator.....	65
Logistical Information	122	Operations involving two or more SAR Authorities	67
Longshore Current.....	142	Organisation	43
Map Reading and Navigation	75	Other Commonwealth Agencies/Authorities	47
Maritime Radio Alarm Signal.....	80	Other Emergency Assistance and Services available from JRCC Australia	70
Maritime Assets.....	253	Other Methods of Communications.....	97
Maritime Border Command	47	Other Types of Distress Alerting Devices.....	86
Maritime Safety Information.....	70	Over Sufficiency of Search Time	259
Maritime SAR Incident.....	101	Overall.....	48
Maritime Search Crews	264	Overview	48, 59, 65, 67
Marking Targets.....	311	Parachute Drift.....	132
Mass Casualty SAR Incidents	205	Parallel Sweep (Multiple Teams)	291
Mattson Consensus	306	Parallel Sweep (Single Team).....	291
Maximum Radio Signal Range Calculations.....	245	Parallel Track Pattern Multi-Unit.....	231
Maximum Search Effort.....	134	Parallel Track Pattern Single Unit	231
Medical Assistance	307	Parallel Track Search Pattern.....	230
Medical Assistance to Vessels at Sea	45	Passive Searching.....	216
Medical Factors	322	Peer Reviews.....	320
Merchant Shipping and GMDSS	91	Person in Water	156
Meteorological Visibility	221	Person Overboard Incident Information	107
MIR Liaison Officer	208	Personnel	66
Miscellaneous Factors	224	Phase Transition	112
Missing person.....	107	Photographic Records.....	79
Modification for the Allocation of Areas to Search Assets Other than Aircraft.....	150	Plant Growth on bones	497
Modification of Areas Incorporating De and Increased Safety Factors.....	150	Pleasure Craft	92
Modification of the Probability Area.....	149	Plotting Drift	145
Modification Resulting from a Shortage of Search Aircraft.....	150	Point and Flank	288
Modification Suggested by Intelligence Information.....	149	Poor Search Conditions	156
Mountain Considerations	172	Position of the Sun.....	223
Mountain Environment	172	Position Uncertainty	152
Mountain Environment Search Strategies	173	Possibility Area.....	136
Mountainous or Rugged Terrain Searches	240	Possible Location of a Distressed Target	131
National and Regional SAR System Organisation	43	Predator Damage to bones.....	499
National Training Framework.....	72	Preparation - Land search briefings.....	300
Naval Vessels	254	Press Releases.....	68
Navigation of SAR Assets (Aviation and Maritime)	228	Probable Errors of Position.....	139
Night Factor	123	Procedures and Practices	97
Night Time Multi-Asset Searches	241	Provision for Entry of Foreign Aircraft during SAR Operations	50
Night-Vision Devices.....	83	Public Relations.....	67
Night Vision Goggles.....	249	Public Relations Officers (PRO's)/Media Officers (MO).....	68
Notification by Airservices Australia	104	Purpose	84
Notification of Next of Kin	69	Purposeful Meandering	289
Objects/evidence.....	108	Qualifications.....	72
Observation Skills	76	RADAR/IFF/SSR	83
		Radio and Distress Beacons.....	84
		Radio Operating Procedures.....	76
		Radios in general	97

Radiotelephony Distress/Emergency Frequencies	81	Search Aircraft Operations	263
Rainforest	166	Search Aircraft Speed	222
RCC/Field Search Headquarters (FSH) Staff.....	61	Search Aircrew Briefing	262
Rear Net.....	95	Search and Rescue Crew Training.....	74
Reasons for Transfer of Coordination	50	Search and Rescue Exercises	74
Recomputed Datum	154	Search and Rescue Resources.....	65
Record Keeping.....	214	Search and Rescue Roles	62
Recorder/Logger.....	64	Search and Rescue Techniques.....	217
Recording of Events.....	103	Search and Rescue Visual Signals	91
Recording of search areas	196	Search Area.....	150, 299
Records and Reports	317	Search Area Based on Non-Moving Datum	147
Reflex Search	179, 276	Search Area Delineation	210
Reopening a Suspended Search	317	Search Area Description	261
Requesting JRCC Australia Assistance	54	Search Based on Moving Datum.....	148
Requesting Public Assistance	69	Search Briefing.....	261
Requesting State / Territory SAR Authority		Search by Infrared (IR) Devices.....	248
Assistance	55	Search by RADAR	247
Requests for Assistance from Foreign RCCs	51	Search Dog Capabilities	268
Requests for Defence Assistance (DACC)	55	Search Dog teams in Australia	271
Requirement for Training	72	Search Effort Expenditure Rate	134
Requirements for SAR Training	72	Search Pattern Abbreviations.....	262
Rescue Assets	311	Search Pattern Conclusion.....	298
Rescue at Sea.....	310	Search Planning and Evaluation.....	127
Rescue General.....	307	Search Radius (R)	140
Rescue on Land.....	308	Search Response Stages	130
Rescue Planner	64	Search Sequence.....	135
Rescue Planning Operations.....	307	Search Strategies for Land SAR.....	275
Rescue Preparation	67	Search Team Leaders/On-Scene Commanders .	78
Responsibilities as Air Search Coordinator.....	54	Searchers	78
Rip Current.....	143	Searchers or Clue Seekers	299
Risks v Gain Factors	126	Searching	209
River Current	142	Searching in Hazardous Areas	284
RTF Distress Signal.....	82	Sector Search	235
RTF Safety Signal.....	82	Sector Search Pattern for a Vessel	236
RTF Urgency Signal	82	Seeking Medical Advice	334
Safety Frequencies	82	Ship Stations	92
SAR Authority Best Placed to Coordinate.....	49	Sighting and Hearing Reports	119
SAR Authority Responsibilities	59	Signal Heard, Signal Fade Plotting Method	245
SAR Call Signs.....	89	Single File Search	287
SAR Coordination.....	48	Situational Awareness	158
SAR Crew Briefing.....	260	Specific factors of LPB that may affect search	
SAR Crew Debriefing.....	266	planning:	203
SAR Frequencies	88	SPOT Personal Satellite Messenger device (SPOT)	
SAR Management	59	86
SAR Mission Coordinator (SMC)	62	Square Search	290
SAR RADAR Transponder (SART)	88	SRR Coordinates.....	57
SAR Stages	103	Stage One Search: Immediate response.....	217
SAR System Organisation	43	Stage Three Search: Mathematically Derived Area	
Satellites	85	219
Sea Current.....	141	Stage Two Search: Nominated Area Either Side of	
Search Aircraft Height	222	Track	218
		State and Territory Governments.....	45

State Emergency Services (SES).....	267	Training and Exercises	72
State/Territory Police Responsibilities	45	Transfer of Coordination	51
State/Territory SAR Authority Training	73	Transfer of Coordination after Suspension of SAR Action.....	53
Statistical Strategy (Lost Person Behaviour).....	182	Transferring Overall Coordination	51
Subject Matter Expertise and Advice	54	Type of Aviation and Maritime Target.....	221
Subjective/Decision Point Strategy	184	Type of Terrain/Conditions.....	280
Sufficient Search Time for Search Aircraft.....	258	Type of Terrain/Conditions of the Sea.....	221
Supply Drop from Aircraft over Land.....	314	Types of Notification Reports	104
Supply Drop from Aircraft over Sea.....	313	Types of SAR Incidents.....	101
Supply Drop from Helicopter over Sea.....	314	Uncertainty Phase.....	109
Supply Dropping and Delivery of Survival Equipment	313	Uncertainty Phase Initial Action	111
Surf Current	143	Uncorrected Sweep Widths for Fixed-Wing Aircraft (NM) at 500 ft and 1000 ft.....	398
Survival Environment Factors.....	322	Universal Grid Reference	261
Survival Equipment Factors	126	Unlawful Acts.....	71
Survivor.....	87	Urban SAR (USAR).....	206
Survivor Stress Factors	322	Urban Search Patterns.....	296
Suspension/termination of a search when the target is not found.....	315	Urban searching.....	173
Sweep Width (W): Factors affecting Sweep Width	220	Urgency of Response	122
Sweep Width Calculations (W)	225	Use of Aircraft for Rescue	311
Swell/Wave Current	143	Use of Helicopters for Rescue.....	312
Target or Clue Generator.....	299	Use of Merchant Shipping	254
Tasking Search Dog teams.....	271	Use of Rescue Boats and Vessels.....	311
Tasking sheets	212	Use of Top Cover Aircraft with Rescue and MEDEVAC Helicopters	313
Tasks of Contact Search Teams	278	Using all four Formal Search Strategies.....	187
Team and Individual Skills	77	Using Search Dog capability for SAR.....	270
Telephone Triangulation	178	Vehicle Search Patterns	295
Telephone/Radio	95	Visual Horizon: Ankle Rule (Land SAR).....	282
Terrain Factors.....	125, 165, 333	Visual Search Patterns (Aviation and Maritime).....	229
Theoretical Search Strategy (Naismith's Rule) .	180	Volunteer Organisations.....	48, 92
Thuraya Satellite Devices.....	87	Water Hypothermia.....	323
Tidal Streams	141	Water Immersion.....	328
Time Frame for Survival (TFFS)	322	Weather Analysis	122
Top Cover Aircraft.....	264	Weather/Oceanographic Factors	124
Track Line.....	261	Wet-Chill Survivability.....	327
Track Line Overdue Incident.....	153	Who to Train	72
Track Line Search.....	232	Wind Chill.....	326
Track Spacing (S).....	225	Wind Hypothermia	326
Track Sweep.....	287	Working under or within a MIR	207
Training.....	72		

Acronyms and Abbreviations

Acronym/ Abbreviation	Meaning
A	Area or search area
ACMA	Australian Communications and Media Authority
ACFT	Aircraft
AFTN	Aeronautical fixed telecommunications network
ADF	Australian Defence Force
ADFLO	Australian Defence Force Liaison Officer
AGL	Above Ground Level
AIP	Aeronautical Information Publication
ALRS	Admiralty List of Radio Signals
AIS	Automatic Identification System
AIS-SART	AIS Search and Rescue Transmitter
AM	Amplitude modulation
AMVER	Automated Mutual-assistance Vessel Rescue
AMSA	Australian Maritime Safety Authority
AMSL	Above Mean Sea Level
A/SMC	Assistant Search and Rescue Mission Coordinator
ASH	Actual Search Hours
ASRK	Air Sea Rescue Kit (RAAF)
ATA	Actual time of arrival
ATC	Air Traffic Control
ATD	actual time of departure
ATS	Air Traffic Services
ATSB	Australian Transport Safety Bureau
AUMCC	Australian Mission Control Centre
AULUTE	Australian Local User Terminal East
C	Coverage Factor
CAO	Civil Aviation Order
CAR	Civil Aviation Regulations
CASR	Civil Aviation Safety Regulations
C/C	Cabin cruiser
CES	Coast Earth Station (Inmarsat) see also LES
CRS	Coast radio station
CSP	Commence Search Point
CSS	Coordinator surface search (maritime)
CTAF	Common Traffic Advisory Frequency

Acronym/ Abbreviation	Meaning
D	Datum
D	Diameter
DACC	Defence Aid to the Civil Community
De	Total drift error
DCJOPS	Deputy Chief Joint Operations
DCS	Defence Communications Station
DF	Direction finding
DR	Dead-reckoning
DGPS	Differential GPS
DSC	Digital selective calling
dwt	Dead weight tonnes
E	East longitude
E	Total probable error of position
EGC	Enhanced Group Call
ELR	Extra-long range aircraft
ELT	Emergency locator transmitter
EMA	Emergency Management Australia
EO/IR	Electro-Optic/Infrared
EPIRB	Emergency position indicating radio beacon
ERSA	En Route Supplement Australia
ETA	Estimated time of arrival
ETD	Estimate time of departure
FCP	Forward Command Post
FFB	Forward Field Base
F/V	Fishing vessel
Fig	Figure
FIR	Flight information region
FLIR	Forward looking infrared
FM	Frequency modulation
FSH	Field Search Headquarters
Ff	Fatigue Factor
Fs	Safety Factor
Ft	Feet
Fw	Weather Factor
GHz	Gigahertz
GMDSS	Global Maritime Distress and Safety System

Acronym/ Abbreviation	Meaning
GNSS	Global Navigation Satellite System
GPS	Global positioning system
GS	Ground speed
gt	Gross tonnes
h	Hours
HDG	Heading
HPA	Hectopascals
HEL-H	Heavy helicopter
HEL-L	Light helicopter
HEL-M	Medium helicopter
HF	High frequency
HQAC	Headquarters Air Command (Air Force)
HQJOC	Headquarters Joint Operations Command
I/B	Inboard motor
ICAO	International Civil Aviation Organization
IERCC	International Emergency Response Coordination Centre
IFER	In Flight Emergency Response
IFR	Instrument Flight Rules
IGA	The Inter-Governmental Agreement (IGA) on National Search and Rescue Response Arrangements
IMO	International Maritime Organization
IR	Infrared
Inmarsat Ltd	International Maritime Satellite Organisation – formally the international Maritime Satellite Organisation
INS	Inertial Navigation System
INTERCO	International Code of SIGNALS
IPP	Initial Planning Point
JCC	Joint Control Centre (ADF)
JRCC	Joint (aeronautical and maritime) Rescue Coordination Centre
JOSS	Joint Operations Support Staff
KHz	Kilohertz
Km	Kilometre (1000 metres)
Kph	Kilometres per hour
kt	knot (nautical mile per hour)
L or l	Length
LCRS	Limited Coast Radio Station
LED	Light Emitting Diode

Acronym/ Abbreviation	Meaning
LES	Land Earth Station (Inmarsat) synonymous with CES
LHQ	Land Headquarters (Army)
LKP	Last Known Position
LPB	Lost Person Behaviour
LRG	Long range
LO	Liaison officer
LUT	Local user terminal
LW	Leeway
m	Metres
M	Degrees magnetic
MAREC	Maritime SAR recognition code
MASTREP	Modernised Australian Ship Tracking and Reporting System
MAYDAY	When repeated three times, this forms the distress call. Any subsequent messages including self-identification, position, nature of distress and other useful information, forms the <i>distress message</i> .
MAX	Maximum
MBC	Maritime Border Command
MBZ	Mandatory Broadcast Zone
MCC	Mission Control Centre
MCS	Maritime Communications Station
MEDEVAC	Medical evacuation
MF	Medium frequency
MIN	Minimum
MHQ	Maritime Headquarters (Navy)
MHz	Mega Hertz
MMSI	Maritime mobile service identity
MPD	Miles per day
MP	Missing Person
MPP	Most probable position
MRG	Medium range
MSC	Marine supply container (RAAF)
MSI	Maritime safety information
MSLD	Maritime Survivor Locating Devices
MSLS	Maritime Survivor Locating Systems
M/V	Motor Vessel
MTS	Mean track spacing (sector search)
n	Number of required track spacings

Acronym/ Abbreviation	Meaning
N	North Latitude
N	Number of searchers
NAVAREA X	Navigational warning area X(ten)
NAVTEX	Is not provided in Australia
NBDP	Narrow-Band Direct Printing
NM	Nautical mile
NOTAM	Notice to airmen
NOK	Next of Kin
NVD	Night Vision Devices
NVG	Night Vision Goggles
NVIS	Night Vision Imaging System
O/B	Outboard motor
OSC	On-scene coordinator
P	Pacing (Land Search speed)
PAW	Police Air Wing
P/C	Pleasure craft
PIW	Person in water
PLB	Personal locator beacon
PLS	Position Last Seen
POA	Probability of Area
POB	Persons on board
POD	Probability of detection
POM	Period of Mobility
PPE	Personal Protective Equipment
PR	Public relations
R	Radius
RAAF	Royal Australian Air Force
RADAR	Radio detection and ranging
RAN	Royal Australian Navy
RA-Aus	Recreational Aviation Australia
RB	Rescue boat
RC	River current
RCC	Rescue Coordination Centre (Local)
RFDS	Royal Flying Doctor Service
ROW	Rest of the World
RPAS	Remotely Piloted Aerial Systems (also known as drones, UAVs)

Acronym/ Abbreviation	Meaning
RV	Rescue Vessel
S	Track spacing
S	South latitude
SART	Search and Rescue Radar Transponder. Also known as 'Survival Craft Radar Transponder' or 'Radar Transponder'
SF	Signal Fade
SH	Signal Heard
S/V	Sailing vessel
SafetyNET	Communications service provided via Inmarsat-C for promulgation of maritime safety information, including shore-to-shop relays of distress alerts and communications for search and rescue coordination
SAR	Search and rescue
SAREX	Search and Rescue Exercise
SART	Search and Rescue Radar Transponder. Also known as a survival craft radar transponder or radar transponder
SC	Sea current
SDB	SAR Datum Buoys
SECURITE	The safety signal 'SECURITE' indicates that the station is about to transmit a message concerning the safety of navigation or providing an important meteorological warning. The safety message is preceded by the word 'SECURITE' spoken three times.
SEND	Satellite Emergency Notification Device
SES	State Emergency Service
SH	Search Headquarters
SITREP	Situation report
SLDMB	Self-Locating Datum Marker Buoy
SMC	Search and rescue mission coordinator
SOLAS	International Convention for the Safety of Life at Sea
SOPs	Standard Operating Procedures
SOS	Internationally recognized signal of distress, made by any method of signalling
SP	Splash point
SPOC	Search and rescue point of contact
SRA	Search and Rescue Asset (Aircraft, vessel, search team)
SRG	Short range
SRR	Search and rescue region
SRS	Single raft system
STOL	Short Takeoff and Landing
SURPIC	Surface picture

Acronym/ Abbreviation	Meaning
T	Time
T	Degrees True
T	Search time available
TAS	True air speed
TC	Tidal current
TCA	Time of closest approach
TELEX	Teletype
TFFS	Time Frame for Survival
TL	Team Leader
TWC	Total water current
u	Wind speed
UHF	Ultra-high frequency
ULR	Ultra-long range
USAR	Urban Search and Rescue (Collapsed Buildings)
UTC	Coordinated universal time
v	Speed of search object
V	SAR unit ground speed or aircraft true air speed
V	Velocity
Ve	Vegetation Correction Factor
VFR	Visual flight rules
VHF	Very high frequency
VLR	Very long range
VMC	Visual meteorological conditions
VMS	Vessel Monitoring System
VTS	Vessel Tracking System
w	Width
W	Corrected Sweep Width
W	West longitude
W/C	Wind current
W/V	Wind velocity
Wu	Uncorrected sweep width
Wx	Weather Factor
X	Search target position error
Y	Search unit position error

Glossary

Term	Definition
Aircraft Coordinator (ACO)	A person who coordinates the involvement of multiple aircraft in SAR operations.
Aeronautical drift (Da)	Drift caused by bailout trajectory or aircraft gliding distance.
Aeronautical position	Initial position of a distressed aircraft at the time of re-entry, engine failure, aircrew ejection or bailout.
Aircraft glide	Maximum ground distance an aircraft could cover during descent.
Alert Phase	A situation wherein apprehension exists as to the safety of an aircraft or marine vessel, and of the persons on board.
Alerting Post	Any facility intended to serve as an intermediary between a person reporting an emergency and a rescue coordination centre or rescue sub-centre.
ARGOS	A satellite-based location and data collection system.
Awareness Range	Distance at which a search scanner can first detect something different from its surroundings but not yet recognise it.
Awareness Stage	A period during which the SAR system becomes aware of an actual or potential incident.
Captain	Master of a ship or pilot-in-command of an aircraft, commanding officer of a warship or an operator of any other vessel.
Checksum Digit	A digit that is appended to a numeric data element and used to verify its accuracy. Checksum digits are computed by adding the digits of the data element.
Coast Earth Station (CES)	Maritime name for an Inmarsat shore-based station linking ship earth stations with terrestrial communications networks.
Conclusion Stage	A period during a SAR incident when SAR facilities return to their regular location and prepare for another mission.
Coordination	The bringing together of organisations and elements to ensure effective search and rescue response. One SAR authority must always have overall coordination responsibility and other organisations are to cooperate with this agency to produce the best response possible within available resources.
Coordinated Search Pattern	Multi-unit pattern using vessel(s) and aircraft.
Coordinated Universal Time (UTC)	International term for time at the prime meridian.
COSPAS-SARSAT System	An international satellite system designed to provide distress alert and location data from 406MHz distress beacon signals.
Course	The intended horizontal direction of travel of a craft.
Coverage Factor (C)	For parallel sweep searches, Coverage Factor (C) is computed as the ratio of sweep width (W) to track spacing (S). $C = W/S$.
Craft	Any air or sea-surface vehicle, or submersible of any kind or size.
Datum	A geographic point, line, or area used as a reference in search planning.
Datum Area	Area where it is estimated that the search object is most likely to be located.
Datum Line	A line, such as the distressed target's intended track line or a line of bearing, which defines the centre of the area where it is estimated that the search object is most likely to be located.

Term	Definition
Datum Point	A point, such as a reported or estimated position, at the centre of the area where it is estimated that the search object is most likely to be located.
Dead Reckoning (DR)	Determination of position of a target by adding to the last fix the target's course and speed for a given time.
Digital Selective Calling (DSC)	A technique using digital codes which enables a radio station to establish contact with, and transfer information to, another station or group of stations.
Direction of Current	Direction toward which a current is flowing. Also called set.
Direction of Waves, Well or Seas	Direction from which the waves, swells, or seas are moving.
Direction of Wind	Direction from which the wind is blowing.
Distress Phase	A situation wherein there is reasonable certainty that a vessel/aircraft, or person, is threatened by grave and imminent danger and requires immediate assistance.
Ditching	The forced landing of an aircraft on water.
Drift	The movement of a search object caused by environmental forces.
Drift Error (De)	See Total drift error.
Emergency Phase	Emergency phases are based on the level of concern for the safety of persons or target that may be in danger. The three levels of emergency are classified as Uncertainty, Alert, and Distress.
Electro-Optic/Infrared (EO/IR)	Electronic imaging systems which include both visible and infrared sensors that can be used day and night and in low light conditions with the ability to view objects at long distance.
Enhanced Group Call (EGC) System	The international broadcast of coordinated Maritime Safety Information and Search and Rescue related information, to a defined geographical area using a recognized mobile satellite service.
False Alarm	Distress alert initiated for other than an appropriate test, by communications equipment intended for alerting, when no distress situation actually exists.
False Alert	Distress alert received from any source, including communications equipment intended for alerting, when no distress situation actually exists, and a notification of distress should not have resulted.
Fetch	The distance over which the wind blows in a constant direction, without obstruction.
Field Search Coordinator	Term for SMC who coordinates land searches only.
Field Search Headquarters	Land equivalent of a RCC
First RCC	RCC affiliated with the shore station that first acknowledges a distress alert, and which will accept responsibility for all subsequent SAR coordination unless and until coordination is transferred to another RCC.
Fix	A geographical position determined by visual reference to the surface, referencing to one or more radio navigation aids, celestial plotting, or other navigation device.
Forward Looking Infrared (FLIR)	An imaging system, mounted on board surface vessels or aircraft, designed to detect thermal energy (heat) emitted by targets and convert it into a visual display.
General Communications	Operational and public correspondence traffic other than distress, urgency and safety messages, transmitted or received by radio.

Term	Definition
Global Maritime Distress and Safety System (GMDSS)	A global communications service based upon automated systems, both satellite-based and terrestrial, to provide distress alerting and promulgation of maritime safety information for mariners.
Global Navigation Satellite System (GNSS)	Worldwide position and time determination system that includes one or more satellite constellations and receivers.
Great Circle Route	The shortest course between two points on the surface of a sphere. It lies in a plane that intersects the sphere's centre.
Ground Speed (GS)	The speed an aircraft is making relative to the earth's surface.
Heading	The horizontal direction in degrees magnetic in which a target is pointed.
Hypothermia	Abnormal lowering of internal body temperature (heat loss) from exposure to cold air, wind or water.
Indicated Air Speed (IAS)	The aircraft speed shown on the air speed indicator gauge. IAS corrected for instrument error and atmospheric density equals true air speed.
Initial Position Error (X)	The estimated probable error of the initially reported position of a SAR incident.
Inmarsat Ltd	Formally the International Maritime Satellite Organisation
International Iridium SafetyCast Service	The coordinated broadcast and automatic reception of Maritime Safety Information and Search and Rescue related information via the Enhanced Group Call system, using the English language.
International Maritime Satellite Organisation (Inmarsat)	A system of geostationary satellites for worldwide mobile communications services, and which support the Global Maritime Distress and Safety System and other emergency communications systems.
Instrument Flight Rules (IFR)	Rules governing the procedures for conducting instrument flight. Also a term used by pilots and controllers to indicate type of flight plan.
Instrument Meteorological Conditions (IMC)	Meteorological conditions expressed in terms of visibility, distance from cloud, and ceiling less than the minima specified for visual meteorological conditions.
Joint Rescue Coordination Centre (JRCC)	A rescue coordination centre responsible for both aeronautical and maritime search and rescue incidents.
Knot (kt)	A unit of speed equal to one nautical mile per hour.
Last Known Position (LKP)	The Last Known Position is a term used in search planning to indicate the last known location of the person, marine craft or aircraft the target of a search and /or rescue mission. It is also known by its acronym LKP. The LKP may be a boat ramp where a small craft was launched, a reporting point or navigation aid where an aircraft last reported its position or the location where it can be confirmed a person was last sighted e.g., at the start of a walking track. The Last Known Position differs from the other term used in marine search planning of Splash Point or SP.
Leeway (LW)	The movement of a search object through water caused by winds blowing against exposed surfaces.
Land Earth Station (LES)	Land Earth Station (Inmarsat) – synonymous with CES
Local User Terminal (LUT)	An earth receiving station that receives beacon signals relayed by COSPAS-SARSAT satellites, processes them to determine the location of the beacons, and forwards the signals.
Maritime Safety Information (MSI)	Navigational and meteorological warnings, meteorological forecasts and other urgent safety-related messages broadcast to ships.

Term	Definition
MAYDAY	The distress signal “MAYDAY” is used to indicate that a target or person is threatened by grave and imminent danger and requires immediate assistance. It has precedence over all other communications. The distress message is preceded by the word MAYDAY spoken three times. The word is pronounced 'Mayday' from the French m'aider (help me). Any subsequent messages including self-identification, position, nature of distress and other useful information, forms the distress message.
MEDEVAC	Evacuation of a person for medical reasons.
Meteorological Visibility	The maximum range at which a large object, such as landmasses or mountains, can be seen. Also referred to as Meteorological Range.
Mission Control Centre (MCC)	Part of the Cospas-Sarsat system that accepts alert messages from the local user terminal(s) and other mission control centres to distribute to the appropriate rescue coordination centres or other search and rescue points of contact.
Narrow-Band Direct Printing (NBDP)	Automated telegraphy, as used by the NAVTEX system and telex-over-radio.
NAVAREA	A geographical sea area established for the purpose of coordinating the broadcast of navigational warnings. The term NAVAREA followed by a roman numeral may be used to identify a particular geographical sea area.
NAVTEX	Telegraphy system for transmission of maritime safety information, navigation and meteorological warnings and urgent information to ships. NAVTEX is not provided in Australia - see SafetyNet .
Night Vision Imaging System	A self-contained binocular night vision enhancement device, usually including goggles, that: <ol style="list-style-type: none"> 1. is helmet mounted or otherwise worn by a person; and 2. can detect and amplify light in both the visual and near infrared bands of the electromagnetic spectrum. <p>NVIS is a term used to incorporate all of the aspects associated with night vision, including Night Vision Devices and Night Vision Goggles.</p>
On-scene	The search area or the actual distress site.
On-scene Coordinator (OSC)	A person designated to coordinate search and rescue operations within a specified area
On-scene Endurance	The amount of time a facility may spend at the scene engaged in search and rescue activities.
Overall Coordination	The responsibility of the SAR authority to prosecute a SAR operation for a given target in accordance with Volume 1, Chapter 1, section 1.2, Appendix B or the SAR authority best placed to coordinate efforts of the response agencies that may become involved in a SAR action.
Overdue	A situation where a target has failed to arrive at its intended destination when expected and remains missing.
PAN-PAN	The international radiotelephony urgency signal. When repeated three times, indicates uncertainty or alert, followed by nature of urgency. The urgency signal “PAN PAN” is used to indicate that the calling station has a very urgent message to transmit covering the safety of a ship, aircraft or person. It has precedence over all other communications, except distress traffic. The urgency message is preceded by the words 'PAN PAN' spoken three times. The words are pronounced 'Pan pan' from the French panne (a breakdown).

Term	Definition
Personal Locator Beacon (PLB)	Personal radio distress beacon for alerting and transmitting homing signals.
Pilot-in-command	The pilot responsible for the operation and safety of the aircraft during flight time.
Planning Stage	A period during a SAR incident when an effective plan of operations is developed.
Position	A geographical location normally expressed in degrees and minutes of latitude and longitude.
Positioning	Process of determining a position that can serve as a geographical reference for conducting a search.
Possibility Area	(1) The smallest area containing all possible survivor or search object locations. (2) For a scenario, the possibility area is the smallest area containing all possible survivor or search object locations that are consistent with the facts and assumptions used to form the scenario.
Primary Swell	The swell system having the greatest height from trough to crest.
Probability Area	The area in which a missing target and/or survivors are most likely to be found taking into account possible errors in the navigation of the missing target and of the search craft.
Probability of Detection (POD)	The probability of the search object being detected, assuming it was in the areas that were searched. POD is a function of coverage factor, sensor, search conditions and the accuracy with which the search facility navigates its assigned search pattern. Measures sensor effectiveness under the prevailing search conditions.
Recognized Mobile Satellite Service	Any service which operates through a satellite system and is recognised by IMO for use in the GMDSS.
Rescue	An operation to retrieve persons in distress, provide for their initial medical or other needs, and deliver them to a place of safety.
Rescue Coordination Centre (RCC)	The centre from which a SAR incident is controlled and coordinated. The Centre is known by various terms such as the Rescue Coordination Centre, Major Incident Room, Operations Room, Base Station or Field Search Headquarters. For the purposes of this manual these centres will be known generically as the Rescue Coordination Centre or RCC.
Rhumb Line	A line of constant bearing that cuts meridians at the same angle. It is a straight line between two points on a Mercator projection chart.
SafetyNET	Communications service provided via Inmarsat-C for promulgation of maritime safety information, including shore-to-ship relays of distress alerts and communications for search and rescue coordination.
SAR Datum Buoy	Droppable floating beacon that is not self-locating requiring the beacon to be relocated by homing the frequency. Once relocated used to determine actual sea current, or to serve as a location reference.
Scenario	A consistent set of known facts and assumptions describing what may have happened to the survivors and/or target.
Sea	Condition of the surface resulting from waves and swells.
Sea Current (SC)	The residual current when currents caused by tides and local winds are subtracted from local current. It is the main, large-scale flow of ocean waters.
Search	An operation, normally coordinated by a rescue coordination centre, using available personnel and facilities to locate persons in distress.

Term	Definition
Search and Rescue Asset (SRA)	An aircraft, vessel of search team with equipment suitable for the expeditious conduct of search and rescue operations.
Search and Rescue Authority	The authority within an Administration with overall responsibility for establishing and providing SAR services and ensuring that planning for those services is properly coordinated. The national SAR authority in Australia is the Australian Maritime Safety Authority with each of the States and Territories Polices services and the Department of Defence being the SAR Authorities within their jurisdictions. In Australia, the SAR Authority takes on the roles of the SAR Coordinator as described in the IAMSAR Manual.
Search Action Plan	Message, normally developed by the SMC, for passing instructions to SAR facilities and agencies participating in a SAR mission.
Search and Rescue Briefing Officer	An officer appointed, usually by the SMC, to brief departing SAR facilities and debrief returning SAR facilities.
Search and Rescue Case	Any potential or actual distress about which a facility opens a documentary file, whether or not SAR resources are dispatched.
Search and Rescue Coordinating Communications	Communications necessary for the coordination of facilities participating in a search and rescue operation.
Search and Rescue Facility	Any mobile resource, including designated search and rescue units, used to conduct search and rescue operations. The terms unit and asset maybe interchangeable with facility.
Search and Rescue Incident	Any situation requiring notification and alerting of the SAR system and which may require SAR operations.
Search and Rescue Liaison Officer	An officer assigned to promote coordination during a SAR mission.
Search and Rescue Mission Coordinator (SMC)	The suitably trained or qualified official temporarily assigned to coordinate a response to an actual or apparent distress situation. In Australia, the acronym SARMC is also used in some jurisdictions. Throughout this manual, the terms SMC and SARMC are synonymous. Some jurisdictions also use the term A/SARMC to describe the SMC's assistants.
Search and Rescue Plan	A general term used to describe documents which exist at all levels of the national and international search and rescue structure to describe goals, arrangements, and procedures which support the provision of search and rescue services.
Search and Rescue Point of Contact (SPOC)	Rescue coordination centres and other established and recognised national points of contact that can accept responsibility to receive COSPAS-SARSAT alert data to enable the rescue of persons in distress.
Search and Rescue Region (SRR)	An area of defined dimensions, associated with the national rescue coordination centre (JRCC Australia), within which search and rescue services are provided.
Search and Rescue Service	The performance of distress monitoring, communication, coordination and search and rescue functions, including provision of medical advice, initial medical assistance, or medical evacuation, through the use of public and private resources, including cooperating aircraft, vessels and other craft and installations.
Search and Rescue Stage	Typical steps in the orderly progression of SAR missions. These are normally Awareness, Initial Action, Planning, Operations, and Mission Conclusion.

Term	Definition
Search Area	The area determined by the search planner to be searched. This area may be subdivided into search sub-areas for the purpose of assigning specific responsibilities to the available search facilities.
Search Endurance (T)	The amount of "productive" search time available at the scene also known as Available Search Hours (ASH). This figure is usually taken to be 85% of the on-scene endurance, leaving a 15% allowance for investigating sightings and navigating turns at the ends of search legs.
Search Facility Position Error (Y)	Probable error in a search target's position, based on its navigational capabilities.
Search Object	A ship, aircraft, or other target missing or in distress or survivors or related search objects or evidence for which a search is being conducted.
Search Pattern	A procedure assigned to an SRA for searching a specified area.
Search Radius	The actual search radius used to plan the search and to assign search facilities. It is usually based on adjustments to the optimal search radius that are needed for operational reasons.
Secondary Swells	Swell systems of less height than the primary swell.
SECURITE	The safety signal 'SECURITÉ' indicates that the station is about to transmit a message concerning the safety of navigation or providing an important meteorological warning. The safety message is preceded by the word "SECURITE" spoken three times. The word is pronounced 'See-cure-e-tay' from the French sécurité.
Self-Locating Datum Marker Buoy	A droppable floating beacon that is self-locating. Used to determine actual sea current, sea surface temperature or to serve as a location reference.
SEND	SEND Satellite Emergency Notification Device. Mobile, personal distress alerting device that functions outside the COSPAS-SARSAT System (for example SPOT, Thuraya SatSleeve). SENDs use different satellite communication constellations eg. Iridium, Global star or Thuraya. Distress alert messages are received by the IERCC in Houston and relayed to the RCC as required.
Sensors	Human senses (sight, hearing, touch, etc.), those of specially trained animals (such as dogs), or electronic devices used to detect the object of a search.
Set	Direction towards which a current flows
Situation Report (SITREP)	Reports, from the OSC to the SMC or the SMC to interested agencies, to keep them informed of on-scene conditions and mission progress.
Splash Point	A term used in maritime search planning to indicate a known point of distress. Also referred to by its acronym SP.
SOS	Internationally recognised signal of distress, made by any method of signalling.
Surface Drift	Vector sum of total water current and leeway. Sometimes called Total Drift.
Surface Picture (SURPIC)	A list or graphic display from a ship reporting system of information about vessels in the vicinity of a distress situation that may be called upon to render assistance.
Surface Position	The position of the search object on the earth's surface at the time of initial distress, or its first contact with the earth's surface.
Sweep Width (W)	A measure of the effectiveness with which a particular sensor can detect a particular object under specific environmental conditions.

Term	Definition
Swell	Condition of the surface caused by a distant wind system. The individual swell appears to be regular and smooth with considerable distance between rounded crests.
Swell Direction	The direction from which a swell is moving. The direction toward which a swell is moving is called the down swell direction.
Swell Face	The side of the swell toward the observer. The backside is the side away from the observer. These definitions apply regardless of the direction of swell movement.
Swell Velocity	Velocity with which the swells advance with relation to a fixed reference point, measured in knots.
Time of Closest Approach (TCA)	Time during a satellite pass when the satellite is closest to a signal source.
Total Drift Error (De)	Sum of the individual drift errors from the time of the incident until datum. Used when determining Total Probable Error (E).
Total Probable Error (E)	The estimated error in the datum position. It is the square root of the sum of the squares of the total drift error, initial position error, and search facility position error.
Total Water Current (TWC)	The vector sum of currents affecting search objects.
Track Spacing (S)	The distance between adjacent parallel search tracks.
Triage	The process of sorting survivors according to medical condition and assigning them priorities for emergency care, treatment, and evacuation.
True Air Speed (TAS)	The speed an aircraft is travelling through the air mass. TAS corrected for wind equals ground speed.
Uncertainty Phase	A situation wherein uncertainty exists as to the safety of an aircraft or a marine vessel, and of the persons on board.
Unreported	A situation where a target has failed to report its location or status when expected and remains missing.
Vector	A graphic representation of a physical quantity or measurement, such as wind velocity, having both magnitude and direction.
Visual Flight Rules (VFR)	Rules governing procedures for conducting flight under visual meteorological conditions. In addition, used by pilots and controllers to indicate type of flight plan.
Visual Meteorological Conditions (VMC)	Meteorological conditions expressed in terms of visibility, distance from cloud, and ceiling equal to or better than specified minima.
Wave (or Chop)	The condition of the surface caused by local wind and characterised by irregularity, short distance between crests, whitecaps, and breaking motion.
Wind-Corrected Heading	The actual heading an aircraft is required to fly to make good an intended course.
Wind Current (WC)	The water current generated by wind acting upon the surface of water over a period of time.

This page has intentionally been left blank

Volume 1- Search and Rescue Administration

NATIONAL SEARCH AND RESCUE MANUAL

2023 EDITION Version 1 – February 2023

Chapter 1 SAR System Organisation

1.1 Organisation

Global SAR System Organisation

- 1.1.1 The international Civil Aviation Organization (ICAO) and the International Maritime Organization (IMO) coordinate, on a global basis, member States' efforts to provide search and rescue (SAR) services. Briefly, the goal of ICAO and IMO is to provide an effective worldwide system, so that wherever people may be in danger, in the air or at sea, SAR services, as referenced in the International Aeronautical and Maritime Search and Rescue Manual, will be available if needed. The overall approach a State takes in establishing, providing and improving SAR services is affected by the fact that these efforts are an integral part of a global SAR system. Land SAR is a function of SAR within each State/Territory jurisdiction.
- 1.1.2 Search and rescue services are defined as the performance of distress monitoring, communication, coordination and search and rescue functions, including provision of medical advice, initial medical assistance, or medical evacuation, through the use of public and private resources, including cooperating aircraft, vessels and other target and installations.
- 1.1.3 In providing assistance to persons in distress and to survivors of SAR incidents, member States shall do so regardless of the nationality or status of such a person or the circumstances in which that person is found.
- 1.1.4 Under this global approach, Australia has taken responsibility for the coordination of SAR in the Australian Search and Rescue Region (SRR) as shown in section 1.4.2. JRCC Australia in Canberra is the Joint Rescue Coordination Centre (JRCC) responsible for the SRR. There are no designated rescue sub-centres (RSC) within the Australian SRR.

National and Regional SAR System Organisation

- 1.1.5 Australia, by being party to the Safety of Life at Sea (SOLAS) Convention, the International Convention on Maritime Search and Rescue, and the Convention on International Civil Aviation, has accepted the obligation to provide aeronautical and maritime SAR coordination and services for its territories, territorial seas, and the high seas within its SRR.
- 1.1.6 Australia, in acceding to the International Convention on Maritime Search and Rescue, 1979, noted that the implementation of the Treaty throughout Australia would be effected by the Commonwealth, State and Territory authorities having regard to their respective constitutional powers and arrangements concerning the exercise of their legislative, executive and judicial powers. The responsibilities of the authorities are set out in the relevant following paragraphs.
- 1.1.7 Australia has established a national SAR System that involves Commonwealth, State and Territory authorities and organisations: The Australian Maritime Safety Authority and the Australian Defence Force at the Commonwealth level; and the relevant police service or force at the State and Territory level, are the relevant SAR Authorities within Australia.
- 1.1.8 The Inter-Governmental Agreement (IGA) on National Search and Rescue Response Arrangements as signed by the responsible Commonwealth, State and Territory Ministers is at Appendix A in accordance with the IGA Commonwealth and the State and Territory search and rescue authorities shall each provide without charge unless otherwise agreed, such assistance or facilities as may reasonably be requested by the SAR authority with overall co-ordination of a SAR operation.

-
- 1.1.9 A SAR authority that hires or requisitions privately owned facilities for a SAR operation will, unless otherwise agreed between the SAR Authorities, bear any costs of hiring or payment of compensation for such requisitioning.
 - 1.1.10 The costs of a SAR response to an activated distress beacon will be borne by the SAR Authority that tasks the SAR Facility.
 - 1.1.11 Where the resources required to respond to a SAR incident exceed those available to any SAR Authority, or where the circumstances require significant coordination across Party agencies, a SAR incident may develop into an emergency management response. Where a SAR incident results in State, Territory or national emergency plans or arrangements being activated, they are to be activated in support of national SAR response arrangements established through the IGA.
 - 1.1.12 Volume 1, Chapter 1, “SAR System Organisation” of the National Search and Rescue Manual constitutes the National Search and Rescue Plan for Australia.

Australian Maritime Safety Authority (AMSA)

- 1.1.13 In accordance with Annex 12 of the Convention of International Civil Aviation, the Commonwealth Government, through the Australian Maritime Safety Authority (AMSA), accepts responsibility for the provision of Search and Rescue Services for civil and internationally registered aircraft in Australia’s SRR. The meaning of civil registered is taken to include those aircraft on the VH register managed by the Civil Aviation Safety Authority (CASA) and on the Recreational Aviation Australia (RA-Aus) register which the RA-Aus manages on behalf of the CASA. The responsibilities for the coordination of Aviation SAR response is exercised by JRCC Australia on behalf of AMSA.
- 1.1.14 The Commonwealth Government through AMSA, in accordance with of the Safety of Life at Sea (SOLAS) Convention and the International Convention on Maritime Search and Rescue, accepts responsibility for the coordination of maritime SAR for persons on or from a vessel at sea. These responsibilities are exercised jointly through JRCC Australia on behalf of AMSA and State and Territory Police.

JRCC Responsibilities

- 1.1.15 JRCC Australia is staffed continuously and is responsible for:
 - a) Coordinating SAR in respect of civil registered aircraft;
 - b) Coordinating maritime SAR for persons on or from a vessel at sea (jointly with police);
 - c) Managing the Australian Mission Control Centre (AUMCC) for the COSPAS - SARSAT distress beacon locating system;
 - d) Operation of the Modernised Australian Ship Tracking and Reporting System (MASTREP);
 - e) Promulgation of Maritime Safety Information (MSI);
 - f) Provision of information on maritime activities such as oil pollution, offshore mineral exploration and dumping at sea;
 - g) Providing assistance to other Australian SAR agencies to fulfil their obligations; and
 - h) Providing assistance to other Australian and emergency response authorities to enable them to meet their obligations in regard to SAR.
- 1.1.16 The Australian Maritime Safety Authority (AMSA) is a Commonwealth statutory authority that provides support and commercial services to the Australian maritime industry. AMSA is responsible for setting and regulating standards for the operation of commercial shipping and domestic commercial vessels, the operation of an extensive network of marine navigation aids around the Australian coast, aviation and maritime search and rescue and the protection of the marine environment.
- 1.1.17 JRCC Australia is AMSA’s operational point of contact and provides a communications and coordination support function for marine pollution response. The Australian Maritime Safety Act 1990 sets out the functions of AMSA, including “the combating of pollution in the marine environment”. The Protection of the Sea (Powers of Intervention) Act 1981 implements the International Convention relating to intervention on the high seas in cases of oil pollution

casualties and the protocol to that convention. AMSA is the managing agency for the National Marine Oil Spill Contingency Plan, and the National Marine Chemical Spill Contingency Plan.

- 1.1.18 JRCC Australia has a number of other roles during emergencies including as outlined by the Australian Government:
- a) Disaster Plans; and
 - b) National Security, crisis and Emergency Management arrangements.
- 1.1.19 JRCC Australia can coordinate AMSA's search and rescue assets in support of wider emergencies as appropriate, including major bushfires or other disasters.

Medical Assistance to Vessels at Sea

- 1.1.20 The Joint Rescue Coordination Centre (JRCC) Australia is operated by the Australian Maritime Safety Authority (AMSA), a Commonwealth statutory authority established under the Australian Maritime Safety Act 1990. The International Convention on Maritime Search and Rescue 1979 requires parties to the Convention to provide (among other things) on request, medical advice, initial medical assistance and medical evacuation (MEDEVAC).
- 1.1.21 JRCC Australia will coordinate these services in the Australian search and rescue region (SRR). JRCC Australia will arrange medical advice through a dedicated Tele Medical Advice Service (TMAS).
- 1.1.22 The assessment by the TMAS doctor determines the type and level of medical assistance required. This includes when a person is deemed to be in grave or imminent danger and requires immediate assistance and medical evacuation. For search and rescue (SAR) purposes this is considered a "distress" incident.
- 1.1.23 If a MEDEVAC is required, the JRCC will determine the most appropriate way to safely remove and transport the casualty to a medical facility or a place where medical assistance can be provided. Considerations including, vessel type and facilities, time of day, on-scene weather, available assets, location (in particular distance offshore), requirements for accompanying medical staff and suitability for recovery of patient by helicopter, may all play a factor in determining the most appropriate MEDEVAC response.
- 1.1.24 Once the requirement for a MEDEVAC and the use of state and territory resources is confirmed JRCC Australia may, in consultation with Australian state and territory health organisations, transfer coordination of the medevac incident to the appropriate jurisdictional contact.
- 1.1.25 If on TMAS advice the person/s requiring evacuation life is not at risk, the circumstances would not require a medical evacuation for SAR purposes. In these circumstances, a medical transport of the person should be arranged as considered appropriate; assistance can be requested of JRCC Australia to identify suitable assets as required.

State and Territory Governments

- 1.1.26 Police are the SAR Authorities in each State and Territory. The Australian Federal Police is the SAR Authority for the Australian Capital Territory, the Jervis Bay Territory and other populated Commonwealth territories.

State/Territory Police Responsibilities

- 1.1.27 State and Territory Police Services are responsible for coordinating SAR in respect of:
- a) Persons and vehicles on land;
 - b) Persons and vessels on inland waterways and in waters within the limits of the ports of the relevant State or Territory;
 - c) Persons on or from a vessel at sea (jointly with the JRCC);
 - d) Aircraft not included on the CASA and RA-Aus registers including ultra-lights, para-gliders and gyrocopters;

-
- e) Coordinating land searches for missing registered civil aircraft in support of the Australian SAR Authority (JRCC Australia); and
 - f) Coordinating the operations of volunteer rescue organisations within their respective jurisdictions.
- 1.1.28 Whilst the Police are the responsible authority for land SAR they can be assisted by:
- a) State Emergency Services: The SES will provide man power and equipment to enable SAR operations to be carried out. The level of experience and equipment available will vary between States and individual SES assets. A SMC should be familiar with their local SES assets and their capabilities.
 - b) Other Volunteer Groups.
 - c) JRCC: While JRCC is predominantly concerned with maritime and aviation SAR incidents they can be approached to:
 - i) Provide assistance to other Australian SAR agencies to fulfil their obligations particularly with the coordination of multiple air assets; and
 - ii) Providing assistance to other Australian emergency-response authorities to meet their obligations in regard to SAR.
 - d) Australian Defence Force: Under the current DACC arrangements the ADF can be approached to provide assistance, under certain circumstances, to the police in SAR operations.

Australian Defence Force Responsibilities – Military SAR

- 1.1.29 The Commonwealth Government, through the Australian Defence Force (ADF) is responsible for the provision of SAR for all ADF and visiting military ships, aircraft and personnel when undertaking operations and exercises. This responsibility is exercised through Chief of Joint Operations (CJOPS) located at Headquarters Joint Operations Command (HQJOC) unless by mutual agreement, is transferred to the “best placed” SAR Authority.

Headquarters Joint Operations Command

- 1.1.30 CJOPS is responsible for managing and coordinating the ADF's operations on behalf of the Chief of the Defence Force (CDF). The Current Operations Commander within HQJOC is JRCC Australia's principal point of contact with Defence on SAR matters.
- 1.1.31 If a SAR for an ADF asset is required, the Current Operations Commander in consultation with the HQJOC Joint Personnel Recovery Officer (JPRO)/Search and Rescue Officer (SARO) will coordinate any available assets from the respective services and recommend an appropriate ADF SAR Commander and SMC be appointed to coordinate the SAR operation. The HQJOC JPRO/SARO will remain involved as the SMC or as a conduit for information flow to government and civil SAR authorities.

Airservices Australia

- 1.1.32 Airservices Australia 1.1.32 All Air Traffic Services (ATS) assets, as a function of their alerting service responsibilities, have a responsibility for the declaration of SAR Emergency Phases for aircraft, to classify the severity of emergencies and alert JRCC Australia.
- 1.1.33 In addition, all ATS assets are required to act as intermediaries between persons reporting an aircraft in need of assistance and JRCC Australia.
- 1.1.34 ATS assets are responsible for providing in-flight emergency response (IFER) services. ATS assets are required to refer incidents likely to culminate in a forced landing, ditching or crash to JRCC Australia at the earliest opportunity.
- 1.1.35 To the extent that their traffic responsibilities allow, ATS assets are required to provide communications between the search aircraft and the responsible SAR Authority. This normally

involves the relay of requests, instructions and information between the responsible JRCC and aircraft.

Other Commonwealth Agencies/Authorities

- 1.1.36 A number of Commonwealth organisations have a special interest in emergency operations; they provide helpful ancillary services, or have SAR facilities that may be of assistance in special cases.

Bureau of Meteorology (BOM)

- 1.1.37 Provides routine or special weather forecasts, wind history and a description of past and present weather reports.

Emergency Management Australia (EMA)

- 1.1.38 The Commonwealth Government, through Emergency Management Australia (EMA), is responsible for coordinating any Commonwealth assistance to States/Territories following natural or technological disaster. The National Emergency Operations Centre (NEOC) in Canberra exercises this responsibility.
- 1.1.39 State/Territory Governments have constitutional responsibility, within their borders, for coordinating and planning for the response to natural or technological disasters and civil emergencies. When the total resources (government, community and commercial) of an affected State/Territory cannot reasonably cope with the needs of the situation, the State/Territory Government can seek assistance from the Commonwealth Government through EMA.

Maritime Border Command

- 1.1.40 Maritime Border Command (MBC) is a joint ADF and Australian Customs agency that coordinates and manages the Australian Civil Surveillance Program and may provide assets to assist during SAR incidents.
- 1.1.41 In accordance with IMO directive MSC/Circ. 1073, MBC is the Australian Security Forces Authority with the responsibility for providing the response to acts of violence against ships.

Australian Communications and Media Authority (ACMA)

- 1.1.42 The Australian Communications and Media Authority (ACMA) regulate the use of radio frequencies and may assist with direction finding services. ACMA also issues and maintains a database of maritime call sign allocations to Australian holders of maritime radio licenses.

Australian Transport Safety Bureau (ATSB)

- 1.1.43 The ATSB is responsible for investigating accidents and incidents involving certain transport services in Australia. Australian SAR Authorities have responsibility for notifying ATSB of accidents or incidents. ATSB can provide SAR Authorities with information about the location of past aircraft crash sites, which can be useful in identifying wreckage located during search actions.

Civil Aviation Safety Authority (CASA)

- 1.1.44 CASA sets aviation safety regulatory standards affecting the civil aviation industry. CASA can provide advice on aircraft and pilot performance, safety matters and maintain the Aircraft Register.
- 1.1.45 CASA through the Office of Airspace Regulation (OAR) is responsible for the declaration of Restricted or Danger Areas during search and rescue operations when appropriate.

Volunteer Organisations

- 1.1.46 Volunteer rescue organisations are located throughout the country and their focus is primarily one of promoting safety and carrying out local rescues. The State or Territory SAR authority is

responsible for the coordination and control of operations conducted by the volunteer organisations during search and rescue operations.

- 1.1.47 Volunteer organisations include groups such as the SES, Volunteer Marine Rescue groups (VMR), Surf Life Saving Australia (SLSA), Federated Mountain Rescue (FMR) and other state equivalents. These groups will provide search teams as appropriate.

Commercial and Private Organisations

- 1.1.48 There are certain commercial and private organisations that are capable of providing assistance during SAR incidents.
- 1.1.49 Some of these organisations have facilities that are immediately suitable for use as SAR assets; others have facilities that have been adapted by way of providing them with extra equipment or training.
- 1.1.50 Assets considered suitable for the provision of SAR services are described as Search and Rescue Assets (SRAs). The crews of these assets are trained in search and rescue techniques.
- 1.1.51 Aircraft and marine craft in transit may be able to assist in cases of distress within their area of operations. Commercial towing and salvage companies may provide vessels to take over the towing or salvage of a vessel that is no longer in immediate danger. The owner or agent of the disabled vessel usually makes arrangements for these services. SAR assets should not interfere with this form of private enterprise providing the commercial facilities are capable of completing the operation safely.
- 1.1.52 Other organisations that might volunteer to assist in a SAR operation include commercial airlines, general aviation operators, oil and mine companies, fishing companies, aero clubs, mission stations and other community groups and organisations.

1.2 SAR Coordination

Overview

- 1.2.1 There are two levels of SAR response in Australia:
- The Commonwealth level through AMSA (JRCC Australia) and the ADF; and
 - The State/Territory level through the Police.
- 1.2.2 Volunteer organisations work in close liaison with State and Territory Police and the Police retain overall coordination of those organisations within their jurisdiction.
- 1.2.3 It is common for a number of SAR Authorities to contribute to one SAR operation. Therefore it is vital that one SAR Authority is responsible for the overall coordination of the SAR operation and the other Authorities involved will cooperate to produce the best response possible within available resources.

Alerting Post

- 1.2.4 Any SAR Authority may receive a distress alert as an Alerting Post, making them responsible for onward distribution to the responsible SAR Authority.
- 1.2.5 In this instance, the receiving SAR Authority will consult with the responsible SAR Authority as per Appendix B at the earliest opportunity to reach an agreement about the best placed SAR Authority to assume overall coordination.
- 1.2.6 For land SAR incidents, determination of best placed will take into consideration the protocol outlined in Appendix C, the Land SAR Coordination Procedure, in addition to Appendix B.

Determination of SAR Authority Responsible for Overall Coordination

- 1.2.7 The fundamental aim of a SAR system is to provide assistance to persons in distress. To achieve this aim the SAR system has to locate, support and rescue persons in distress in the shortest

possible time. The success of the SAR response therefore depends on the speed with which the SAR situation is evaluated and the SAR operation is planned and carried out.

- 1.2.8 To ensure the SAR response is successful there are certain principles of SAR coordination that must be observed.

Initial Response

- 1.2.9 The first SAR Authority to become aware of a SAR incident is obliged to respond until overall coordination can be transferred to the SAR authority best placed to coordinate.

SAR Authority Best Placed to Coordinate

- 1.2.10 Normally the SAR Authority best placed to be the Overall Coordinator of a SAR incident will be the SAR Authority identified in Appendix B as responsible for the target type.
- 1.2.11 Appendix B identifies the responsibilities and functions to a SAR Authority based on the type of target that requires assistance from the SAR service and then additionally, in some circumstances, by the location of the SAR incident.
- 1.2.12 Appendix B represent the table of National search and rescue responsibilities and functions where the table:
- a) Identifies the divisions of responsibilities between SAR Authorities; and
 - b) Identifies the functional breakdown that SAR Authorities perform by, for or on behalf of, the overall coordinating SAR Authority.
- 1.2.13 However, it can be determined after consultation that another SAR Authority (other than the one specified in Appendix B) is best placed to coordinate. In this instance, overall responsibility may be transferred by mutual agreement.
- 1.2.14 The circumstances may include better communications, closer proximity to the area of search, better access to sources of intelligence, expertise in specialised areas or more readily available facilities.
- 1.2.15 For example, JRCC Australia is normally best placed to coordinate wide area air searches and coordinate search and rescue operations at sea at long range. These operations may also involve requests for ADF assistance. Police forces are normally best placed to coordinate local ground searches or inshore boat searches.
- 1.2.16 The coordination of a police land-based search cannot be transferred to JRCC Australia. However, JRCC Australia may provide support on request in accordance with the procedures stated below in “JRCC Australia Assistance to Other SAR Authorities”.
- 1.2.17 As Police always retain responsibility for land SAR incidents, transfer will only be possible between Police Services/Forces for incidents that occur on State Borders. Police cannot transfer responsibility for land SAR incidents to JRCC Australia. Land SAR Incidents involving military personnel may be able to be transferred to the ADF under certain circumstances. However, JRCC Australia may provide support on request in accordance with the procedures stated below in “AMSA Assistance to other SAR Authorities.”
- 1.2.18 A SAR Authority may not be better placed if it is already engaged in responding to another SAR incident/s or it does not have sufficient resources to be able to coordinate effectively.
- 1.2.19 The SAR authority with overall coordination may request assistance from another SAR authority. In such circumstances the Overall Coordinator may delegate to another SAR Authority responsibility for a specific part of the SAR operation.
- 1.2.20 From time to time, a SAR operation may be commenced independent of a SAR authority. Once a SAR authority is alerted to the incident it is their responsibility to coordinate the activities of the responding assets in order that the integrity of the search is maintained until such time as the SAR Authority best placed to coordinate the incident has been determined under this plan or the incident concludes.

Effective Consultation and Coordination

- 1.2.21 In order to ensure the successful prosecution of a SAR incident involving more than one SAR authority, the SMC with overall coordination shall initiate consultation with all participating SAR Authorities at the commencement of an incident. The SMC should conduct frequent reviews of the progress of the incident and produce a SITREP at regular intervals. This should not preclude all participants offering advice and suggestions.
- 1.2.22 All SAR authorities have specialised knowledge within their specific area of expertise and operation, therefore the SMC should consult with other authorities to establish what assistance is available.

Cooperation with Foreign Rescue Coordination Centres

Coordination Principles with Foreign RCCs

- 1.2.23 When the area of SAR operations is near or straddles the boundaries between international search and rescue regions (SRR), JRCC Australia is to be informed and will take overall coordination, except for SAR involving military forces as previously discussed. JRCC Australia will liaise with neighbouring foreign RCCs in accordance with the relevant International SAR Arrangements. In general, the following procedures reflect the SAR Arrangements in place.
- 1.2.24 When the position of a party in distress is known, the responsibility for initiation of SAR action will be that of the International RCC in whose SRR the party is located.
- 1.2.25 The International RCC to assume responsibility for conduct of a SAR action when the distressed target's position is unknown shall be the RCC responsible for:
- The SRR in which the target was operating according to its last reported position; or
 - The SRR to which the target was proceeding if the last reported position was at the boundary of two SRRs; or
 - The SRR to which the target was destined if it was not equipped with suitable two-way radio communication equipment or not under obligation to maintain radio communication.
- 1.2.26 If, after a SAR action has been initiated, it is determined that the area of probability lies across the boundaries of two or more adjoining SRRs, the initiating RCC shall normally remain the responsible SAR Authority.
- 1.2.27 Alternatively, where search areas are extensive, it may be agreed that JRCC Australia coordinates search efforts in the Australian SRR and the adjacent International RCC coordinates search efforts in the foreign SRR. Should this be considered the preferable strategy, JRCC Australia may initiate the proposal to its foreign counterpart.

Provision for Entry of Foreign Aircraft during SAR Operations

- 1.2.28 JRCC Australia shall take responsibility for organising the entry into and departure from the Australian region, outside of the Australian Sovereign territory (12 Nautical Miles off coast line), foreign state aircraft engaged in SAR operations.
- 1.2.29 Any Foreign State aircraft entering the 12 NM limit will require submitting a Diplomatic Clearances through Department of Defence via phone 02 612 84819 or email to ForeignAircraft.Requests@defence.gov.au, and will require involvement from the relevant country's Embassy or High Commission. JRCC may assist in facilitating this requirement.
- 1.2.30 If another SAR authority becomes aware of a foreign state aircraft being tasked to conduct SAR operations in the Australian region, they should inform JRCC Australia immediately who will help facilitate approvals and diplomatic clearances as necessary.

Requests for Assistance from Foreign RCCs

- 1.2.31 JRCC Australia or the Department of Foreign Affairs and Trade (DFAT) may receive requests from foreign RCCs for Australian assistance in SAR operations. If requests are received via DFAT, JRCC

Australia shall immediately establish communications with the RCC responsible for the area to establish and arrange any assistance that may be required.

Transfer of Coordination

Reasons for Transfer of Coordination

- 1.2.32 The SAR authority with overall coordination should evaluate all available information and intelligence and make an initial assessment of the probable search area and assets required. If the required response is assessed as being beyond the capacity of the authority then that authority should request assistance at an early stage. Delaying requests for assistance, may lead to reduced chances of survival and/or significant increase in the size of the search area.
- 1.2.33 Overall coordination responsibility may be transferred from one SAR authority to another within Australia's SRR in the following circumstances:

- a) Where a SAR authority has activated a SAR operation in response to a distress or other emergency situation that is found to be outside their responsibility.

For example, a SAR operation is mounted by JRCC Australia in response to a distress beacon activation that is, having established the nature and location, found to be a land environment incident or a pleasure craft/fishing vessel in distress where Police are better placed to respond. In such a case JRCC Australia, depending on the operational circumstances of the SAR response, may transfer overall coordination of the SAR operation to the responsible State or Territory Police Service or Force.

- b) When a RCC is fully committed, overall coordination of a further incident in that region may be transferred to an adjacent RCC.

Note: JRCC Australia is considered to be an adjacent RCC to State and Territory RCCs.

- c) Whenever more accurate knowledge of the distressed target's position or movements comes to hand.
- d) When it becomes apparent that a SAR authority other than the one initiating the action is more favourably placed to assume responsibility.
- e) Where a SAR operation is beyond the State/Territory's capabilities. This might include situations where vessels are well to sea or along a remote part of the Australian coastline and beyond the capabilities of the SAR facilities available to the State/Territory agencies.
- f) Where the circumstances of the SAR operation requires the implementation of the State or Territory's disaster plan or the declaration of a State or Territory Emergency. For example, an aircraft incident where there are many fatalities and/or injured. In these cases, once appropriate State/Territory resources are on site, the appropriate State/Territory authority will assume overall coordination of the operation.
- g) For a major search where JRCC Australia has assumed overall coordination from a State/Territory SAR authority and the air search has been completed but local land and inshore operations may continue, overall coordination may be transferred back to the appropriate State/Territory authority.

Transferring Overall Coordination

- 1.2.34 A transfer of coordination responsibility between SAR Authorities may be effected at any time by a SAR Authority requesting another SAR Authority to assume overall coordination (or by another SAR Authority offering to take coordination) in accordance with Appendix B. In these instances:
- a) Consultation shall take place between the SMC's of both SAR Authorities concerned and verbal agreement reached on which SAR Authority is best placed to continue to coordinate the incident and the reasons for accepting coordination.
- b) Transfer of coordination will formally occur at the time verbal agreement is made by the appropriately qualified person(s) who is authorised to accept coordination.

-
- c) Full details of all relevant information and actions taken by the initiating SAR Authority shall then be passed in accordance with the information exchange requirements outlined in Appendix C.
 - d) If overall coordination cannot be accepted immediately, the initiating SAR Authority shall retain coordination until a mutually agreed time of transfer;
 - e) All assets or SAR Authorities concerned shall be advised of the transfer of coordination.
- 1.2.35 In assuming coordination for the SAR incident, it is essential that the accepting SMC is aware that SAR assistance from the (current) Coordinating SAR Authority may not be available depending on the reasons for the transfer of overall coordination.
- 1.2.36 Where a SAR Authority accepts overall coordination of an incident, the SMC shall ensure that full responsibility for the incident is accepted, in which case:
- a) The accepting SMC shall ensure that all aspects, including air and surface search, are coordinated by their authority.
 - b) If an aspect of the search (e.g. air search) is to be supported by, or remain with another SAR Authority, then the terms of the assistance shall be made clear and that Authority shall be required to report progress and keep the SMC with overall coordination informed as to developments.
- 1.2.37 On completion of the SAR incident, it might be determined appropriate to transfer the event back to the original coordinating SAR Authority.

Accepting Coordination for a Component of the SAR Event from another SAR Authority

- 1.2.38 Where an Authority decides to accept coordination for a component of an event (e.g. air search) from another SAR Authority, the accepting SMC shall ensure that responsibility for specific functions (e.g. air search) is accepted, in which case:
- a) Transfer of coordination will formally occur at the time verbal agreement is made by the appropriately qualified person(s) who is authorised to accept coordination.
 - b) The accepting SMC shall operate within the terms of the agreed responsibility and report progress to the SAR Authority with overall coordination; and
 - c) Conduct the specific functions in accordance with accepted standards, procedures and practices.

Guidance in Support of Transferring Coordination of a Component of a SAR Operation

- 1.2.39 Where the overall coordinator needs or requires another cooperating SAR Authority to take responsibility for a component of a SAR event or a specific activity in the SAR event the cooperating Authority must be provided with:
- a) Clear objectives, scope and scale of the delegated responsibility and service required;
 - b) Full briefing on the SAR event to the extent that it will affect the service to be provided;
 - c) Conditions and constraints on use of assets;
 - d) Time requirements and constraints; and
 - e) Tactical intelligence, information and data as it becomes available that may affect the progress of the support service provided.
- 1.2.40 The cooperating Authority must:
- a) Accept, or reject the proposed delegation. If the action is other than to accept the delegation then the coordinating Authority must be informed of the operational reasons;
 - b) Operate within the terms of reference for the supporting service;
 - c) Inform the coordinating Authority of any circumstances, if they arise where the specified service cannot be provided or needs to be varied, together with reasons;

-
- d) Exchange with the coordinating Authority, tactical intelligence, information and data as it becomes available that may affect the progress of the SAR event; and
 - e) Report progress of the support activity to the coordinating Authority.

Transfer of Coordination after Suspension of SAR Action

- 1.2.41 When a SAR action is suspended, the authority with overall coordination at the time shall inform all authorities, assets and facilities that have been activated and/or alerted.
- 1.2.42 If, at the time of suspension, the search is under the overall coordination of the Authority responsible for the target type, as identified in Appendix B; overall coordination shall not be transferred to another SAR authority. Rather, the Police, and other SAR agencies involved in the SAR operation, should be informed that the search has been suspended pending the availability of further intelligence. The Police may then instigate further Police (non-SAR) actions as appropriate.
- 1.2.43 Where a search is suspended for a target that another SAR authority has responsibility for under the terms of Appendix B, overall coordination shall be transferred to that authority. The expectation would be that if further intelligence is received that indicates the search should be re-commenced, the SAR authority that has normal responsibility for the target will consider its capability to coordinate the search at that time and either retain coordination, seek assistance or transfer coordination. Also, it may be necessary for that authority to fulfil their coronial or missing person responsibilities.
- 1.2.44 On occasions, after the suspension of a search, it may be necessary for State/Territory Police to continue to search for bodies or aircraft/vehicle/vessel wreckage. In such cases JRCC Australia may:
 - a) Provide briefings on flight path or vessel track prior to disappearance, splash/crash point, area searched and related intelligence;
 - b) Review intelligence to assist search;
 - c) Source aircraft for transport or search purposes;
 - d) Brief search crews on (a) above; and
 - e) Provide drift information.
- 1.2.45 JRCC Australia will not fund air or surface assets for the search for bodies or aircraft/vehicle/vessel wreckage once the search has been suspended.
- 1.2.46 Should any other organisation, e.g. the operating company, wish to continue an independent search, the SAR Authority with overall coordination should ascertain whether there is any new intelligence that indicates that the search should be continued. If there is:
 - a) New intelligence then this should be evaluated and, if considered valid, the search should be continued/re-initiated; or
 - b) No new intelligence then the Police/RCC may assist the requesting organisation with:
 - i) Briefings on path prior to disappearance, splash/crash point, area searched and related intelligence; and/or
 - ii) Drift information;
 - iii) Briefings on MP behaviour and intentions, LKP area searched and related intelligence.
- 1.2.47 JRCC Australia will neither fund nor provide air or surface assets for continuation of the search unless the request is supported by new intelligence.

Requesting JRCC Australia Assistance

Subject Matter Expertise and Advice

- 1.2.48 Australian SAR authorities may request assistance or advice from JRCC Australia during a SAR operation. Where resources are available, JRCC Australia can assist with SAR planning, briefings, prediction and management tools for a maritime or aviation search.

Briefings

- 1.2.49 JRCC Australia can deliver a range of services as follows.
- 1.2.50 In circumstances where assistance is required to task a marine or aviation SAR asset, the coordinating SAR Authority can request JRCC Australia to prepare a briefing for those assets. JRCC Australia will:
- a) Prepare and provide the briefing and email it to the coordinating SAR Authority for the crew; or
 - b) Prepare and provide the briefing and email it directly to the crew, copied to the coordinating SAR Authority.
- 1.2.51 Land SAR assets will be briefed by the police SMC coordinating the incident. Aviation and maritime SAR assets being utilised in a land SAR incident will generally be briefed by the police SMC.

Aviation Capability

- 1.2.52 Where significant aviation assets beyond reasonable normal capacity of the State/Territory are required to contribute to a SAR response plan, JRCC Australia can assist with aviation capability by providing three levels of aviation assistance:
- a) Identification of suitable aviation SAR assets to conduct a search and pass details to the requesting authority.
 - b) Identification and briefing of suitable aviation SAR assets.
 - c) Identification, briefing and tasking of suitable aviation SAR assets.
- 1.2.53 If assistance a) or b) is requested, then JRCC Australia will provide the relevant information to the coordinating SAR Authority to assist in further developing the SAR response plan.
- 1.2.54 If assistance c) is requested, JRCC Australia will task the asset but will still remain in a supporting role to the coordinating SAR Authority.
- 1.2.55 All subsequent activities that are related to monitoring progress of the air search, reaction to intelligence and re-allocation of aircraft to modified search allocations would remain with the coordinating SAR Authority
- 1.2.56 The cost of coordinating and responding to a search and rescue incident will be borne by the tasking SAR Authority unless otherwise agreed.

Responsibilities as Air Search Coordinator

- 1.2.57 On request, JRCC Australia can take responsibility for a wide scale air search in support of a SAR operation under the overall coordination of another SAR Authority. The following procedures will apply:
- a) The search area will be determined by mutual agreement between the coordinating SAR Authority and JRCC Australia;
 - b) When additional intelligence is received that may entail changes to the search area, the revised search area will be determined by mutual agreement between the coordinating SAR Authority and JRCC Australia;
 - c) JRCC Australia will conduct the complete air search including aircraft identification, briefing, tasking and de-briefing, air asset performance monitoring and intelligence analysis;
 - d) All aircraft tasking details will be provided to the coordinating SAR Authority;

-
- e) The coordinating SAR Authority and JRCC Australia will exchange and consider search area information and intelligence to ensure that coordination of the event is effectively achieved;
 - f) When the air search has been completed and there is high confidence that if the target was in the search area it would have been found, and appropriate consideration for the probability of survival has occurred, the air search will be suspended pending the availability of new intelligence; and
 - g) Requests to extend or continue the air search must be supported by the presence of new intelligence. If the air search is continued for other reasons, the costs of that continuation will be borne by the coordinating SAR Authority and not JRCC Australia.
- 1.2.58 AMSA will pay all the costs for the air search unless option (g) above is applicable.
- 1.2.59 Requests for assistance from the JRCC Australia will be made in accordance with the information exchange requirements outlined in Appendix C.

1.3 Requesting State / Territory SAR Authority Assistance

Requests for Defence Assistance (DACC)

Localised Emergency Assistance to Save Life

- 1.3.1 In localised emergency situations when immediate action is necessary to save human life, the RCC/local SAR Authority may request assistance directly from the commander of an ADF asset on scene or in the area. In these circumstances ADF commanders are authorised to provide assistance from within their asset's resources to civil Authorities. Within Defence this type of localised assistance is categorised Defence Assistance to the Civil Community (DACC) Category 1.
- 1.3.2 Whenever this action is taken the SMC shall advise JRCC Australia as soon as possible, and the commander of the ADF asset will advise their superior Headquarters as soon as possible. JRCC Australia is to follow up with a courtesy call to Headquarters Joint Operations Command (HQJOC).

All Other Requests for Defence SAR Assistance

- 1.3.3 In circumstances other than those described above, civilian SAR Authorities/SMC shall pass requests for ADF assistance to JRCC Australia who will liaise with Headquarters Joint Operations Command (HQJOC). Once a military asset has been assigned, further contact can be with the Service concerned. JRCC Australia will contact the appropriate military asset to discuss with the mission commander/crew an appropriate search tasking for the asset
- 1.3.4 All requests for ADF assistance are to include as much detail as possible about the search target, where assets are required, how long assets are likely to be required, what other search assets are in the area, who is the coordinating SAR Authority, what logistic support can be provided to the ADF and the relevant points of contact.
- 1.3.5 Any verbal request will be followed by a hard copy message.

Defence Requests for Civil Assistance

- 1.3.6 In localised emergency situations when immediate action is necessary to save human life, ADF authorities will liaise directly with local SAR authorities/providers for the provision of civil support to ADF SAR operations.
- 1.3.7 In other than immediate, life threatening circumstances, the ADF will pass requests for civil SAR assistance in support of military SAR operations to JRCC Australia for on forwarding to the appropriate civilian SAR Authorities/SMC and the facilitation of the provision of support.

1.4 Australian Search and Rescue Region

- 1.4.1 The Australian search and rescue region covers the Australian continent and large areas of the Indian, Pacific and Southern Oceans as well the Australian Antarctic territories.

1.4.2 This is nearly 53 million square kilometres (one tenth of the earth's surface) and borders the search and rescue regions of 10 other countries.

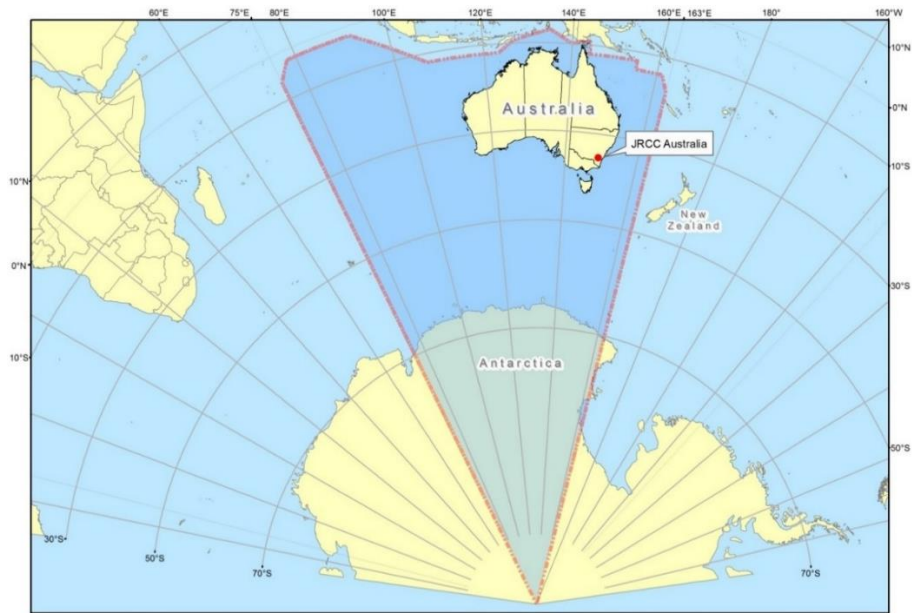

Figure 1: Australian Search and Rescue Region

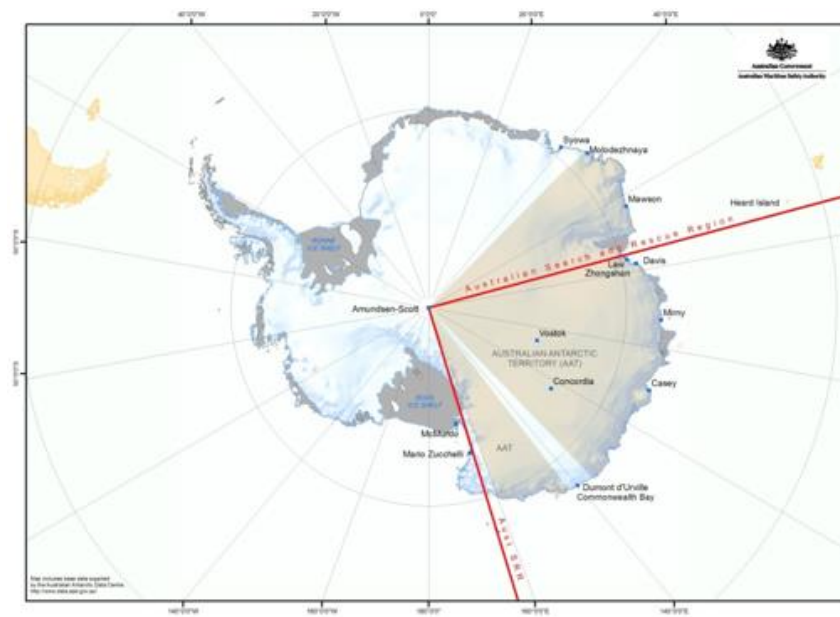

Figure 2: Australian SRR Antarctic Region

1.5 SRR Coordinates

1.5.1 The coast of the Antarctic continent in longitude 75° E thence

6° 00' S 75° 00' E	9° 37' S 141° 01' E
2° 00' S 78° 00' E	9° 08' S 143° 53' E
2° 00' S 92° 00' E	9° 24' S 144° 13' E
12° 00' S 107° 00' E	12° 00' S 144° 00' E
12° 00' S 123° 20' E	12° 00' S 155° 00' E
9° 20' S 126° 50' E	14° 00' S 155° 00' E
7° 00' S 135° 00' E	14° 00' S 161° 15' E
9° 50' S 139° 40' E	17° 40' S 163° 00' E
9° 50' S 141° 00' E	Thence to the coast of the Antarctic continent in longitude 163° 00' E

Note: The Australian maritime and aviation SRRs are generally the same except that the maritime SRR only extends to the Antarctic coast whilst the aviation SRR extends to the South Pole; and there is a minor difference in the North East corner of the SRR.

1.6 Australian States and Land Search Area



Figure 3: Australian States and Land Search Areas

- 1.6.1 The Police Services in each State and Territory are responsible for Land Search and Rescue within the boundaries of their respective State or Territory, including any islands. The ACT is also responsible for a small area of land at Jervis Bay, NSW.

Statistics		
State/Territory	Population	Size (km2)
Australian Capital Territory	387 000	2 452
New South Wales	7 544 500	811 428
Northern Territory	246 000	1 346 200
Queensland	4 470 900	1 787 100
South Australia	1 688 700	1 024 377
Tasmania	515 000	67 800
Victoria	5 866 300	227 600
Western Australia	2 589 100	2 525 500
Territories	6,500	*300
Total	24 000 000	*7 617 930

* Not including Antarctica

Chapter 2 SAR Management

2.1 Overview

- 2.1.1 There are three levels of management within the SAR system.
 - a) Overall management of SAR responsibilities by SAR Authorities;
 - b) Management of individual SAR incidents by SAR mission coordinators (SMCs); and
 - c) Direction of SAR activities at an incident by on-scene coordinators (OSCs) specifically designated by the SMC.
- 2.1.2 This section outlines, in general terms, the management and coordination actions required when a decision is made to implement procedures in prosecuting a SAR.
- 2.1.3 Once it is decided to proceed with the action, plans should be enacted for the commencement of search activity with a minimum of delay. Coincident with progressing search activity, is the development of a rescue plan and obtaining and deploying rescue resources to minimise time between survivors' location and their recovery to a place of safety.

SAR Authority Responsibilities

- 2.1.4 A SAR Authority shall ensure that a SAR operation can be promptly initiated and prosecuted with the efficient use of available SAR resources, until rescue has been completed or until chance of success is no longer a reasonable possibility.
- 2.1.5 The State or Territory Police shall ensure that a land SAR operation can be promptly initiated and prosecuted with the efficient use of available SAR resources, until rescue has been completed or until chance of success is no longer a reasonable possibility.
- 2.1.6 SAR Authorities have overall responsibility for establishing, staffing, equipping and managing the SAR system, including providing appropriate legal and funding support, establishing RCC/FSHs, providing or arranging for SAR assets, coordinating SAR training and developing SAR policies, as listed at Appendix B. SAR Authorities will focus upon resources to conduct SAR operations for which they are the Responsible Authority (Appendix B). The SAR authority, where applicable, shall:
 - a) Designate an SMC for a specific SAR incident
 - b) Establish a Rescue coordination Centre (RCC/FSH) to coordinate all participating search and rescue assets and facilities;
 - c) Ensure that the RCC/FSH conforms to the SAR procedures contained in this manual or local SOPs and manuals;
 - d) Establish close liaison and formulate agreements with other authorities and organisations having SAR potential;
 - e) Establish liaison with SAR Authorities of adjacent areas to ensure mutual cooperation and coordination in combined operations;
 - f) Ensure that a comprehensive and current SAR plan is prepared and distributed;
 - g) Establish and supervise communication facilities and assign SAR frequencies from those authorised to assets designated for SAR tasks;
 - h) Establish communications with adjoining RCC/FSHs and appropriate organisations to ensure two-way alerting and dissemination of SAR information;
 - i) Ensure immediate action is taken to provide assistance, advising the appropriate SAR Authorities and passing all information received concerning the distress incident and any action taken;

- j) Ensure that the operating authority or agency of any craft, aviation asset or land party in need of assistance has been advised of initial actions taken, and they are kept informed of all pertinent developments;
- k) Ensure that the Next of Kin (NOK) of any missing person/s has been advised of initial actions taken, and they are kept informed of all pertinent developments;
- l) Ensure that each incident is prosecuted until assistance is no longer necessary, rescue has been completed or chance of success is no longer a reasonable possibility;
- m) Ensure that if the scope of the maritime/aviation operation exceeds the authority's capacity to plan and execute the operation, it shall seek advice and assistance from, or by mutual agreement, hand over coordination, to an appropriate authority;
- n) Ensure that if the scope of the land operation exceeds the local capacity to plan and execute the operation, the FSH shall seek advice and assistance from the respective State SAR Coordinator for the provision of assets and/or personnel from other areas
- o) Maintain and preserve adequate records; and
- p) Develop new and improved techniques and procedures.

Forward Command Post

- 2.1.7 It may be desirable to establish a Forward Command Post or a Forward Field Base at a suitable location. The feasibility of FCP/FFB establishment will be a matter for consideration by the SAR Authority.
- 2.1.8 As the name suggests a Forward Field Base (FFB) differs from a Forward Command Post (FCP) in that a Forward Field Base does not involve transfer of any coordination responsibilities from the parent RCC/FSH.
- 2.1.9 JRCC/FSH will commonly establish a FFB at an aerodrome being used by several search aircraft for the purpose of managing tasking, allocation of personnel and equipment and conducting briefings and debriefings. A FFB may be also set up in conjunction with a Police headquarters or Police FCP to facilitate liaison between Authorities and agencies involved in a search and rescue operation.
- 2.1.10 The degree of delegation attributed to the FCP/FFB and its actual responsibilities shall be at SMC discretion, bearing in mind the need for:
 - a) A clear understanding of respective responsibilities; and
 - b) An optimum response to the operational and administrative features of the current situation e.g.: location of search area and availability of staff.
- 2.1.11 After considering how best to exercise control over SAR assets in remote sectors of an SRR or where communications, administrative or political factors impact on operational efficiency, an SMC may recommend to management to establish a FCP/FFB close to the incident.
- 2.1.12 The responsibilities of the OIC of an FCP/FFB throughout a particular SAR action shall be delegated by the SMC and may include:
 - a) Briefing and debriefing members of search teams during a land search operation;
 - b) Briefing and debriefing search crews operating aircraft from an aerodrome close to the search area;
 - c) Establishment of a base for helicopter operations, not at an aerodrome;
 - d) Coordinating, as required, the provision of safety, survival and SAR equipment to participating SAR aircraft and helicopters;
 - e) Collation of intelligence information and provision of logistical support;
 - f) Liaison between JRCC/FSH, police and emergency services;

- g) Supervising the allocation of observers, and ensuring they obtain adequate rest; and
- h) Making arrangements for food, accommodation and transport for search crews and observers when required.

Notes:

- 1) Where an aerodrome is to be used for a FCP/FFB; the aerodrome operator/owner should be consulted prior to the final decision being made to establish an FCP/FFB at the location.
 - 2) For the broader responsibilities given to a SMC by a Police Search Commander, see Volume 2, Chapter 3.7.1 of this manual.
- 2.1.13 In considering the establishment of a FCP/FFB, the Search Commander/SMC shall consider communications requirements and existing facilities including terrestrial networks, satellite communication links, mobile phones, facsimile machines and facilities available through other agencies, e.g. JRCC/FSH Australia, Police, Defence assets and State/Territory Emergency Services.
- 2.1.14 When selecting a location for a FCP/FFB the Search Commander/SMC shall consider:
- a) Navigation aids;
 - b) Geographical limitations;
 - c) Aerodrome or landing area suitability and proximity to the search area;
 - d) Apron capacity;
 - e) Refuelling capabilities;
 - f) Maintenance and logistical support;
 - g) Crew briefing facilities; and
 - h) Availability of accommodation in the vicinity.

RCC/Field Search Headquarters (FSH) Staff

- 2.1.15 RCC/Field Search Headquarters (FSH) staff perform duties in the prosecution of search and rescue events. In addition they have responsibility for maintaining the RCC/FSH in a continuous state of preparedness. RCC/FSH staff shall consist of personnel who are experienced and trained in SAR operations. When a period of heavy activity is anticipated or during major SAR incidents, the regular staff may be supplemented as required.
- 2.1.16 Authorities and agencies that may be involved in providing services to an RCC/FSH in the event of an incident e.g. JRCC Australia/FSH, State and Territory Police, Airservices Australia, ADF, Bureau of Meteorology (BOM) and ACMA are to be alerted as early as practicable so that staffing can be managed.
- 2.1.17 Search Headquarters (SH): This is set up by the Search Commander (Normally a Commissioned Officer) who is responsible for co-ordinating the overall search effort. It will normally be at an existing Police Station or Police Headquarters, whichever is appropriate.
- 2.1.18 Search Headquarters provides effective support to the Field Search Headquarters.
- 2.1.19 All pre-search information is evaluated by the SMC at a convenient location prior to instituting a search. This location may vary from the home of the SMC when the initial call comes through to a police station if the SMC is already on duty. During this stage, there is a danger that rumours and false information may produce an over-reaction and cause organisations and individual volunteers to enter the search area and disturb clues. It is suggested that the minimum number of searchers, consistent with effectiveness and safety, is most likely to lead to success in a land search and rescue operation.
- 2.1.20 Initial Actions: When the Search Commander has made the decision to mount a search, based on the information and advice supplied by the SMC, and a Field Search Headquarters and Support

Base have been deployed to the search area, there are positive actions that should be initiated, as follows:

- a) Establish a communications net appropriate to the location and conditions;
- b) Advise all stakeholders of the location of the RCC/FSH, radio channels, telephone numbers and email addresses;
- c) Commence or continue incident logs, chronological and decision, where possible. Format of the log is dependent on the situation, recording equipment and personnel available. At the very least it should be hand written;
- d) Establish an incident command system, identifying the SMC and those involved in the incident; and
- e) Establish a white board, or visual aid, of the search details and plans.

Search and Rescue Roles

SAR Mission Coordinator (SMC)

- 2.1.21 Each SAR operation is carried out under the coordination of a SAR Mission Coordinator (SMC) designated for the purpose by the appropriate SAR Authority. The role of the SMC may vary between SAR Authorities depending on their command arrangements. The SMC must understand the extent of their authority and responsibility and must be capable of taking immediate and adequate action, basing their decisions on knowledge, logic and good judgement.
- 2.1.22 The SMC must have completed appropriate SAR training and must review and maintain proficiency as per the organisational procedures. The SMC/SARO must be capable of performing all SAR functions required by the SAR Authority.
- 2.1.23 To fulfil the foregoing requirements, the SMC/SARO must have a good knowledge of the communications available, the geographical features of the region, and the capabilities and limitations of SAR assets. The SMC/SARO must use initiative and be inquisitive in the search for information, cross-checking the sources in doubtful cases.
- 2.1.24 The SMC is the person coordinating a SAR incident, who is suitably qualified to undertake the coordination role (this will vary between State/Territories). Their responsibilities include the prompt dispatch of appropriate and adequate SAR assets and the prosecution of SAR operations until rescue has been completed, or chance of success is no longer a reasonable possibility.
- 2.1.25 The SMC is responsible for ensuring that the following duties are carried out depending on the SAR incident and local circumstances:
 - a) Obtaining and evaluating all information pertaining to the incident, including emergency equipment carried by the aircraft/vessel/vehicle/person in distress;
 - b) Classifying the SAR incident into the appropriate emergency phase (Uncertainty, Alert/Urgency, or Distress);
 - c) Alerting appropriate SAR assets and SAR organisations that may be of assistance during the incident;
 - d) In consultation with other SAR Authorities, confirming which Authority will exercise overall coordination in accordance with Appendix B;
 - e) Conducting a risk assessment;
 - f) Dispatching SRs immediately, if situation warrants;
 - g) Conducting initial communications checks. If unsuccessful, making an extended communications search to obtain additional information on the incident, personnel involved and equipment carried by the vessel, aircraft or party in distress;
 - h) Calculating the search area. Preparing optimum plans and promulgating attainable plans;
 - i) Obtaining past/present/forecast weather, drift information and oceanographic conditions if applicable;

-
- j) Providing for SAR crew briefing, dispatching of appropriate SRAs, or other assets;
 - k) Organising logistical support for all SAR assets including fuel, food and accommodation, through to the completion of the incident;
 - l) Making arrangements for appropriate communications;
 - m) Maintaining a continuous, chronological plot showing, for example sighting and hearing reports, DF bearings, air plot, RADAR plot, fixes, reports of debris, areas searched or not searched and other intelligence;
 - n) Maintaining a continuous, chronological record or log of the search effort, including actions taken in relation to intelligence, SRAs employed, sorties, hours flown/underway, sightings, leads, results obtained, message traffic, briefing notes, telephone calls, daily evaluation of progress and probability of detection;
 - o) Initiating maritime distress broadcasts or maritime information broadcasts and initiating the alerting of enroute aircraft. Consideration should be given to arranging for announcements to be made over radio and TV networks;
 - p) Arranging communication schedules when and if needed;
 - q) Requesting additional SAR assets, as required;
 - r) Exercising overall coordination of SAR assets;
 - s) Determining the Time Frame for Survival (TFFS) in consultation with a medical practitioner if required.
 - t) Maintaining liaison with the next of kin, owner, agent or management of the missing craft or persons;
 - u) Keeping all authorities involved fully advised of SAR incident progress with timely and regular situation reports (SITREPs). SITREPs should be sent in a numbered sequence;
 - v) Making recommendations in relation to the continuation or suspension of searches;
 - w) Issuing news media releases on the progress of incidents in accordance with the local SAR organisational procedures and policies;
 - x) Providing debriefs of SRA's, cancel alerts, release SAR assets and organisations involved, and issuing the final SITREP to all concerned; and
 - y) Acting as required to cope with unique, unusual or changing circumstances of the emergency.

- 2.1.26 Where a SAR Authority has overall coordination of a SAR operation, the SMC shall give particular attention to the following matters as relevant to the search:
- a) In conjunction with the meteorological office, keeping a watch on weather conditions in the probability area, routes used by SAR assets in transit to and from the search area and at aerodromes used as bases or alternate aerodromes for search aircraft;
 - b) Coordination of search aircraft in the light of operational conditions by diverting or recalling aircraft or reassigning search areas as conditions dictate;
 - c) Planning so as to minimise conflict between search aircraft in adjoining areas;
 - d) Attending to logistical requirements, in particular, accommodation, fuel, availability of relief crews and observers and all necessary ground facilities at aerodromes to be used by SAR assets;
 - e) Coordination of the use of maritime resources and facilities and efficient distribution of message traffic regarding sea state and weather conditions which may affect marine craft engaged in search activities;
 - f) Provision of regular information to those agencies responsible for land search assets about actual and forecast weather conditions which may affect their operations;
 - g) Ensure that all search assets are kept informed about actions and developments affecting their operations;

-
- h) Make effective use of personnel from other SAR authorities, medical agencies, public relations, company representatives and maritime authorities; and
 - i) Keeping other authorities, which have been given coordination of search assets, informed of overall search progress and strategy.
- 2.1.27 The SMC may have access to other SAR qualified personnel. Some functions may be shared where there are insufficient numbers of staff to allocate individual tasks to a staff member. The following roles are listed for completeness.

Assistant SAR Mission Coordinator (A/SMC) Responsibilities and Duties

- 2.1.28 As the title implies, the A/SMC assists, and is subordinate to, the SMC assigned to a particular SAR mission. The term is used by some Australian jurisdictions to describe officers with SAR qualifications that allow them to provide significant support to the SMC.
- 2.1.29 The A/SMC is under the direct supervision of the SMC and therefore has the full operational authority of the SMC when carrying out specific duties assigned.
- 2.1.30 The A/SMC is responsible for routine documentation, allocation of SRAs and presentation of the search plan under the direction of the SMC. Each SAR Authority will recognise specific duties applicable to the A/SMC function.
- 2.1.31 Officers performing A/SMC duties should, as a rule, hold SARO qualifications, but requirements vary with the structure of the SAR organisation. Generally, the title A/SMC refers to the person assisting the SMC.

Allocator/Planner

- 2.1.32 An Allocator/Planner is responsible to the SMC for the determination of a probability area, allocation of appropriate search assets to specific areas, and when required brief and debrief search crews.

Recorder/Logger

- 2.1.33 A Recorder/Logger, if required, shall maintain an accurate and up-to-date chronological record of the SAR action, together with other necessary records, messages and details of telephone calls and radio logs.

Briefing Officer

- 2.1.34 A Briefing Officer shall be responsible for briefing and debriefing search assets.

Intelligence Officer

- 2.1.35 An Intelligence Officer shall be responsible for:
- a) Liaison with the duty meteorological officer for the supply of planning forecasts and periodic updates of weather information;
 - b) Plotting, assessing and filing of sighting and hearing reports;
 - c) Interrogating witnesses and assessing other reports;
 - d) Obtaining data about the missing persons and/or target;
 - e) Obtaining logistical data relating to the search area; and
 - f) Supervising the personnel employed in gathering intelligence.
- 2.1.36 The Intelligence Officer shall immediately advise the SMC of any information that is considered to be significant.

Rescue Planner

- 2.1.37 A Rescue Planner shall be responsible for devising and coordinating a rescue plan. The rescue plan shall include the pre-positioning of supplies for an airdrop to survivors, the positioning of suitable rescue facilities at appropriate locations and the pre-hospital medical needs of survivors.

Liaison Officer

- 2.1.38 Liaison Officers or advisers from other authorities/interested parties, when required, may be sought from or provided by JRCC/RCC/FSH, the aircraft operator, police, military authorities etc. and shall liaise between the RCC/FSH and their parent organisations on matters of their specialisation. The use of liaison officers is encouraged during SAR operations that may become protracted.

On Scene Coordinator

- 2.1.39 When a number of SAR assets are working together on the same SAR mission in the same location, there may be an advantage if one assets is assigned to coordinate the activities of all participating assets. The SMC will designate this role to an On Scene Coordinator (OSC), who may be the person in charge of a ship or aircraft participating in the search or someone at another nearby facility in a position to handle OSC duties. The OSC should be the most capable person available, taking into consideration SAR training; communications capabilities of the asset; and the length of time that the asset the OSC is aboard can stay in the search area. Frequent changes in the OSC should be avoided. Duties that the SMC may assign to the OSC, depending on needs and qualifications include:
- a) Assuming operational coordination of all SAR facilities on scene;
 - b) Receiving the search action plan from the SMC;
 - c) Modifying the search action plan based on prevailing environmental conditions and keeping the SMC advised of any changes to the plan (in consultation with the SMC when practicable);
 - d) Providing relevant information to the other SAR assets;
 - e) Implementing the search and rescue plan where required;
 - f) Monitoring the performance of other assets participating in the search;
 - g) Implementing the rescue plan (as required); and
 - h) Providing regular SITREPS to the SMC.

2.2 Search and Rescue Resources

Overview

- 2.2.1 Search and Rescue within the Australian SRR is based on the use of aircraft, marine craft and land facilities which are normally used for other purposes but which can be made available to form part of the SAR effort.
- 2.2.2 The JRCC and each State/Territory Police Jurisdiction shall be responsible for developing and maintaining a facility register. This register will contain the details of all resources that may be able to assist in the prosecution of a land SAR incident. These details may include:
- a) 24 hour contact details
 - b) Type of personnel/asset (12 SES, 1 Bell 412 Helicopter etc.)
 - c) Capabilities of asset (Land Search, Vertical Rescue, Dogs, Diving etc.)
 - d) Availability of asset (24/7, after hours etc.)
 - e) Any costs involved
 - f) Any lead time required.
 - g) Any restrictions
- 2.2.3 The SMC shall arrange for the provision of suitable search assets. The terms SAR asset or SAR facility are used to describe one or more types of air, maritime and/or land-based facility.

-
- 2.2.4 Some of these facilities are immediately suitable for SAR use; others have been adapted by way of providing them with extra equipment or training. A number of assets considered suitable for the provision of SAR services have been designated as specialised SAR assets with trained personnel and are described as SRAs.
 - 2.2.5 AMSA has developed a tiered hierarchy for civil aviation SRAs in Australia that is further explained in Appendix D-9.
 - 2.2.6 Every endeavour should be made to obtain sufficient search assets to search the determined area at a satisfactory coverage factor in the shortest possible time. However certain factors, such as inclement weather or darkness, may make an optimum air search impractical and the use of surface assets should be considered. Search by land facilities alone is usually impractical for large search areas but it can be conducted in most weather conditions and can provide complete coverage of a confined area that cannot be thoroughly searched from the air. Land parties are also critical in operations where the search is carried out from the air and rescue by land facilities.
 - 2.2.7 Identification and deployment of rescue assets shall commence at the time of the initial SAR response and a review of requirements shall continue through the action. Assistance with selection of search assets is given in Volume 2, Chapter 4.8.

Personnel

- 2.2.8 While a SAR assets will conduct a SAR operation under the general direction of the SMC, the person in charge of the asset will retain the responsibility for carrying out the operation assigned to it.
- 2.2.9 Medical personnel should be alerted in a timely manner if it is anticipated that they may be required.
- 2.2.10 Ideally, the best personnel to use in search operations are those who have bush craft, search technique skills and knowledge. Unfortunately, the number of persons with these skills is limited; therefore it may be necessary to supplement search teams with inexperienced personnel.
- 2.2.11 SAR Authorities should ensure that regular training is undertaken by SRAs in their jurisdictions.

Dropmasters, Dispatchers and Observers

- 2.2.12 Many members of the State Emergency Service are trained as Dropmasters, Dispatchers and Observers. Each SMC should be aware of what skills the SES possess as they may be required during a SAR incident.
- 2.2.13 Dropmasters, dispatchers and observers are an integral part of the SAR team and its effective operation.
- 2.2.14 Dropmasters will be required if an aerial delivery of stores is to be made to survivors. The Dropmaster shall be responsible for the preparation of the equipment for delivery and for briefing the drop team and aircrew on dropping techniques. During the drop mission, the Dropmaster will take charge of the aircraft cabin and control the dropping operation. Dispatchers should be available to assist the Dropmaster in the delivery of supplies when required.
- 2.2.15 Whenever possible, trained Observer Leaders and Observers shall be used in all search aircraft. Where it is inevitable that some untrained Observers must be used, the SMC shall make every effort to have at least one trained Observer Leader or Observer in each search aircraft.
- 2.2.16 Sufficient Observers should be assigned to large aircraft to enable the Observer Leader to arrange relief periods. Ideally, search sorties should be approximately of two hours duration.
- 2.2.17 An Observer Leader allocated to an aircraft shall attend the briefing with the pilot or obtain a copy of the briefing, and will then be responsible for briefing Observers allocated to that aircraft. Observer Leaders may be issued with binoculars where available.

-
- 2.2.18 Should a prolonged search be foreseen, Observer Leaders and Observers should be rostered to avoid fatigue. If there are insufficient Observers available locally, additional Observers should be obtained and taken to the area.
 - 2.2.19 It is an SMC responsibility, either directly or by delegation from the SAR Authority, to make reasonable provision for and to monitor the welfare of Observers. This includes the provision of refreshments, accommodation and rest breaks. Local State and Territory Emergency Service assets and aero clubs, especially those from which a number of search aircraft may be deployed, may be of assistance in this regard and should be invited to cooperate in making appropriate arrangements.

Rescue Preparation

- 2.2.20 Planning for rescue shall commence at the time of the initial SAR response and continue throughout the action. Plans shall be appropriately updated, as the circumstances require and at all times consider the pre-hospital medical needs of survivors.
- 2.2.21 For further considerations in rescue planning refer to Volume 2, Chapter 5.

2.3 Public Relations

Overview

- 2.3.1 Search and Rescue operations for missing aircraft and vessels generate considerable publicity. By virtue of its nature, an RCC/FSH is a source of news and this is especially true during SAR incidents. The public should be informed during SAR operations, within the limits of confidentiality, of SAR actions. The potential benefits of early release of information include:
 - a) Additional information from the public, leading to more effective use of SAR resources;
 - b) Fewer time-consuming requests from the news media; and
 - c) Reduction of inaccurate public speculation about the SAR mission.
- 2.3.2 RCC/FSH staff should be governed by their parent authority's public relations procedures when dealing with the media. It is important that a relationship between the media and an RCC/FSH is established such that:
 - a) The media's legitimate interest in an incident of concern and the public's "right to know" is respected;
 - b) Information reaching the public is factual and as complete as possible;
 - c) The operational functioning of an RCC/FSH is not prejudiced; and
 - d) Benefit is derived from publicity of an incident and from media broadcasts for information made at the request of SAR staff.

Operations involving two or more SAR Authorities

- 2.3.3 To avoid confusion in public information it is essential that the overall coordinating authority responsible for the particular SAR action make any news release.
- 2.3.4 The following guidelines are recommended for releasing information on operations involving vessels, aircraft or other facilities during joint operations:
 - a) Inquiries from the public made to one authority concerning the activities of another authority shall be directed or referred to the authority in overall coordination of the incident;
 - b) Where the ADF is the SAR Authority, the ADF is responsible for issuing information to the public. The ADF is to be consulted before any information is released to the public/media; and

-
- c) Where ADF assets are involved in supporting a civil SAR, information on the activities of those ADF assets is not to be released to the public/media without Defence approval. The appropriate authority to consult in Defence is the Public Relations Officer at HQJOC.

Public Relations Officers (PRO's)/Media Officers (MO)

- 2.3.5 SAR Authorities usually have a designated PRO/MO. The PRO/MO, or the officer nominated, should have knowledge of search and rescue and the techniques of disseminating information to the public.
- 2.3.6 The authority of the PRO/MO will be covered by organisational policies and procedures. The commercial distribution of news is highly competitive and therefore news releases must be impartial. Specifically, the PRO/MO will perform the following duties:
 - a) Receive briefings from the SMC, RCC/FSH personnel, SITREPs, SAR log and interviews with rescued personnel if available;
 - b) Make proper and full use of existing news media such as press, radio, television and wire services to disseminate information;
 - c) Establish liaison with media sources early in the mission in order to prevent the SMC from being flooded with requests for information as the mission progresses;
 - d) Keep well informed on the procedures and techniques being used in the search and in which stage the SAR system is functioning at any particular time; and
 - e) Process and review for news-worthiness all photographs taken of mission activities.

Press Releases

- 2.3.7 The early release of information will frequently aid in preventing time-consuming requests from news media concerning the operation. In cases where extensive searches are being conducted release of information to the public may bring important leads to the SMC.
- 2.3.8 News releases should be written following the time-proved format of who, what, where, when, why and how. In drafting a release all six of these items should be covered in paragraph one. Subsequent paragraphs can provide additional detailed information concerning one or more of these questions. By drafting releases in this fashion the news media will be able to chop portions of the release in order to meet their space requirements without damaging the overall story. The release of names can be a sensitive issue and organisational policies and procedures should be established in accordance with privacy guidelines.
- 2.3.9 A good news release will be well written, factual and newsworthy. It should not contain personal opinion, judgements, elaboration, colouring or any classified material. Asking the following questions may test news-worthiness:
 - a) Is story still timely?
 - b) Are the people involved known?
 - c) Is the story unusual?
 - d) Is locality within the range of the news media's interest?
 - e) Does the story have general interest?
 - f) Has the story a personal or human-interest appeal?
- 2.3.10 SAR officers shall not disclose to the media:
 - a) The names of any crew or other missing persons;
 - b) Any personal judgments pertaining to any persons involved in the incident;
 - c) Any comments on the judgment, experience or training of persons involved in the incident;
 - d) Degrading opinions on the conduct of the SAR operation or personalities involved;
 - e) Personal opinions and theories;

-
- f) Names of those associated with the search; and
 - g) Names of persons who have given information relating to the incident.
- 2.3.11 SAR Officers shall not comment on behalf of other SAR Authorities or organisations.
- 2.3.12 Media releases may include the following information:
- a) Type of aircraft, factual detail of the flight, details of the vessel;
 - b) Reason for the SAR operation, e.g. aircraft/vessel overdue, report of impending crash landing; weather situation; beacon activation;
 - c) Owner of the aircraft/vessel (subject to consent);
 - d) Number of missing persons;
 - e) Area being searched;
 - f) Number and types of assets engaged in the search;
 - g) Arrangements for the search;
 - h) Details of other authorities participating in the search; and/or
 - i) Reinforce the positive aspects relating to safety and survival.
- 2.3.13 As the operation progresses, releases should be made periodically to keep the public updated on the progress that is being made. A final release should be made when the mission is concluded. This release should summarise the activities conducted during the operation, giving full particulars on the efforts expended to locate and rescue the distressed persons. The final release should be a complete summary of the incident and detail:
- a) Number of search teams, SES, number of personnel used.
 - b) The number of aircraft missions, total hours flown and use of vessels;
 - c) Auxiliary land or maritime search, if applicable;
 - d) The reasons for termination or suspension; and
 - e) Any other information relevant to the incident that should be made public.

Requesting Public Assistance

- 2.3.14 The SMC may enlist the news media to access information from the general public. In sparsely populated areas, information from the general public may be sought through the media, requesting members of the public to contact the RCC/FSH and/or Crime Stoppers. An RCC/FSH telephone number should be included as part of the release.

Liaison with Relatives

- 2.3.15 Information that may significantly affect the conduct of a search may be obtained from relatives and friends of missing persons. Information relating to the personal history and possible courses of action taken by the missing persons should be collected by officers trained in investigation methods and competent to describe the current and proposed search plan in a reassuring manner.

Notification of Next of Kin

- 2.3.16 The SMC should be aware of the concerns of the relatives of the missing persons. During a search, it is recommended that one staff member should maintain regular contact with the relatives to provide information and outline plans. If appropriate, relatives should be encouraged to visit the RCC/FSH to enable them to see the search effort. Next of kin/relatives should be advised at an early stage of any SAR operation, to ensure where possible that the timing of associated media releases does not cause them undue concern.
- 2.3.17 Where available, police liaison officers should be utilised to give initial advice to relatives and particularly when providing advice that a death or deaths have occurred. It is preferable that this

information can be passed personally rather than by telephone, so as to ensure that appropriate support services are provided.

- 2.3.18 In any event, before a search is suspended or terminated the SMC should ensure that the next of kin are consulted as far as possible. They should be fully briefed on the complete search effort, conditions in the search area, and the reasons for proposing the suspension or termination of the search. Relatives are more able to accept the SMC's decision to suspend or conclude search operations if they are privy to the processes.
- 2.3.19 Whenever foreign nationals are the targets of a search and rescue action, the Department of Foreign Affairs and Trade should be informed.
- 2.3.20 The ADF is the sole authority for releasing any information to next of kin of ADF members.

Casualties

- 2.3.21 State SAR Authorities (Police) will be responsible for the releasing the names of civilian casualties. The names of military casualties of a SAR Incident are only to be released by the ADF or the appropriate national authority for visiting military assets.
- 2.3.22 The names and addresses of survivors shall not be released until a positive check and identification has been accomplished. Generally, survivor information should not be released prior to the release of casualty information, although circumstances may dictate some departure from this procedure. Survivors shall be encouraged to contact their own families as soon as possible and all reasonable assistance towards accomplishing this shall be provided. Controlling the dissemination of information by survivors is difficult and requires tactful briefing. Whenever possible the PRO should brief survivors on what information may be released. Information on survivors who are ADF members or members of foreign military assets is only to be released by the ADF or the appropriate national military authority

2.4 Other Emergency Assistance and Services available from JRCC Australia

General

- 2.4.1 JRCC Australia performs operations other than search and rescue, which, if not carried out, could result in a SAR incident. These operations include:
 - a) Assisting a vessel or aircraft that is in a serious situation and in danger of becoming a casualty, thereby endangering persons on board. This assistance may be by way of direct action, or by way of notification to, and coordination with, other SAR authorities;
 - b) Broadcasting Maritime Safety Information (MSI);
 - c) Alerting appropriate authorities of unlawful acts being committed against an aircraft or ship (Alert Emergency Phase under IAMSAR particularly with respect to Piracy/Armed Robbery Attack);
 - d) Alerting appropriate authorities after a ship or aircraft has been abandoned, to minimise future hazards; and
 - e) The operation of the Modernised Australian Ship Tracking and Reporting System (MASTREP).

Maritime Safety Information

- 2.4.2 Maritime Safety Information (MSI) is coordinated, collated and issued by JRCC Australia as the NAVAREA X Coordinator and National Coordinator for Australia. JRCC Australia broadcasts MSI by satellite using the Enhanced Group Call system and by HF radio, while some Limited Coast Radio Stations (LCRS) will broadcast by MF/VHF radio. Broadcast of MSI serves to assist with preventing SAR incidents from occurring.

Unlawful Acts

- 2.4.3 JRCC Australia may become aware of an aircraft known or believed to be subject to unlawful interference. JRCC Australia will advise Airservices Australia as soon as possible. Appropriate procedures will be implemented should the situation develop to a point that SAR action is, or will be, necessary.
- 2.4.4 Special signals have been developed for use by ships under attack or threat of attack from pirates or armed robbers. "Piracy/Armed Robbery Attack" is a category of distress message for all classes of digital selective call equipment and GMDSS-compliant communications terminals manufactured by recognized mobile satellite service providers. For their own safety, ships may have to covertly send out the "Piracy/Armed Robbery Attack" message.
- 2.4.5 When JRCC Australia becomes aware of such a situation, it should declare a Phase, advise appropriate response agencies in accordance with JRCC Australia Procedures, and begin preparations for possible SAR operations as appropriate. If the ship covertly sends a message care must be taken in any communications sent back to the ship so as not to warn the pirates.
- 2.4.6 JRCC Australia, on receiving a report of piracy/armed robbery attack, would act in accordance with the following:
- a) If the attack is within the Australian SRR, JRCC Australia would:
 - i) Acknowledge the report unless it is suspected that it is a covert report;
 - ii) Notify appropriate security authorities as detailed in JRCC Australia Procedures;
 - iii) Notify the International Maritime Bureau Piracy Reporting Centre;
 - iv) Provide assistance to those Authorities by way of information and provision of communications; and
 - v) Consider the need to notify other shipping in the area.
 - b) If the attack is outside the Australian SRR, JRCC Australia would:
 - i) Acknowledge the report unless it is suspected that it is a covert report;
 - ii) Notify the appropriate RCC;
 - iii) Notify the International Maritime Bureau Piracy Reporting Centre;
 - iv) If the attack is near the boundary of the Australian SRR, notify the Australian security authorities as in (a) above; and consider the need to notify other shipping in the area.

Chapter 3 Training and Exercises

3.1 Requirements for SAR Training

- 3.1.1 The importance of thorough training for all personnel employed on SAR missions cannot be over-emphasised. Failure of a single link in the often complex chain of action required in SAR missions can compromise the success of the operation, resulting in loss of lives of SAR personnel, lives of those that might otherwise have been saved and/or loss of valuable resources. The purpose of training is to meet SAR system objectives by developing SAR specialists. Since considerable experience and judgement are needed to handle SAR situations, necessary skills require significant time to master. Training can be expensive but contributes to operational effectiveness. Quality of performance will match the quality of training.

Training

- 3.1.2 Training is critical to performance and safety. The SAR system should save those in distress when it can, and also use training to reduce risks to its own valuable personnel and resources. Training personnel in making sound risk assessment will help to ensure that these trained professionals and valuable resources remain available for future operations.
- 3.1.3 Consistency in training and sharing of information relating to search and rescue is promoted through the National SAR Council. Standardisation to the prosecution of SAR Operations is encouraged through these avenues.

Who to Train

- 3.1.4 Efforts to ensure professionalism extend to career development for individuals who are assigned to undertake SAR duties. The aim is to ensure SAR officers are competent. In additions, agencies should consider making assignments of sufficient length to develop expertise and take advantage of SAR experience in subsequent assignments of officers.

Requirement for Training

- 3.1.5 Search and rescue organisations are responsible for the establishment of formal training programs for SAR personnel to reach and maintain competence appropriate to their role.
- 3.1.6 Training of SAR personnel should focus on both the practical and theoretical application of SAR and may include the following:
- Study of SAR procedures, techniques and equipment through lectures, demonstrations, films, SAR manuals and journals;
 - Assisting in or observing actual operations; and
 - Exercises in which personnel are trained to coordinate individual procedures and techniques, or operate specialised equipment, in an actual or simulated environment.

3.2 National Training Framework

Qualifications

- 3.2.1 There are several levels of SAR qualifications within Australia:
- Advanced Diploma:** This level of qualification is designed for those personnel managing SAR incidents, whether at the JRCC, ADF or in the police jurisdictions. The Advanced Diploma of Public Safety (Police Search and Rescue Management) has recently been superseded by the new Advanced Diploma of Police Search and Rescue Management. It is available through SAR RTO's with it on scope. Personnel awarded this qualification are generally known as

Senior Search and Rescue Officers (SnrSARO's) and perform a SAR management role within their organisation.

- b) Diploma: This level of qualification is designed for those personnel coordinating SAR incidents, whether at the JRCC, ADF or in the police jurisdictions. The Diploma of Public Safety (Police Search and Rescue Coordination) has recently been superseded by the new Diploma of Police Search and Rescue Coordination. It is available through SAR RTO's with it on scope. Personnel awarded this qualification are generally known as Search and Rescue Officers (SARO's) and perform a SAR coordination role within their organisation.

Public Safety Training Package; Police Training Package

- 3.2.2 The Public Safety Training Package is available for the JRCC and ADF SAR authorities. The qualifications contained within the package are consistent with Australian Qualifications Framework (AQF) guidelines and are endorsed by the National Quality Council.
- 3.2.3 The Public Safety Training Package provides units of competence and qualifications that identify core competency standards for personnel who are involved in SAR activities. Units of competence have been packaged and aligned to a specific qualification within the AQF to establish the qualification level and title.
- 3.2.4 The Public Safety Training Package has been superseded by the Police Training Package for police jurisdiction. This has been developed through extensive consultation involving all state/territory SAR authorities. The qualifications contained within the package are consistent with Australian Qualifications Framework (AQF) guidelines and are endorsed by the National Quality Council.
- 3.2.5 The Police Training Package provides units of competence and qualifications that identify core competency standards for personnel who are involved in SAR activities. Units of competence have been packaged and aligned to a specific qualification within the AQF to establish the qualification level and title.

AMSA Training

- 3.2.6 AMSA provides specialist aviation and maritime search and rescue training to officers primarily in Australia's Joint Rescue Coordination Centre.

The National Search and Rescue Manager's Course

- 3.2.7 The National SAR Manager's Course is the premier course for training SAR Managers to the national standards. The Course is held centrally in Canberra each year, and has been in operation since 1989. (The course was postponed in 2000 for an academic restructure and again in 2020 due to COVID-19 implications).
- 3.2.8 Students are invited to participate from all Australian State/Territory Police Agencies, AMSA the ADF and New Zealand Police.
- 3.2.9 Directing staff of the Course, in addition to support provided by AMSA, are drawn from Australian Police organisations. These officers are subject matter experts in land and maritime search and rescue and are qualified in workplace training and assessment.
- 3.2.10 It is a necessity that all potential instructors on the above courses hold the appropriate Workplace Training and Assessment Certificate prior to undertaking any teaching or assessing.
- 3.2.11 The Queensland Police Service currently manages the Registered Training Organisation (RTO) component of this course.

State/Territory SAR Authority Training

- 3.2.12 In addition to participating in the National Police SAR Managers training program the State/Territory Police organisations in Australia conduct search and rescue specific training with personnel involved, or who may become involved, in SAR operations at a local level.

-
- 3.2.13 This training involves principally land and coastal marine search and rescue operations employing their own personnel and personnel from other State/Territory organisations having a role in local search and rescue missions.
 - 3.2.14 Formal training in the Diploma of Police Search and Rescue Coordination and Advanced Diploma in Police Search and Rescue Management is conducted by two registered training organisations associated with the Australian Police Services, with access provided to all police jurisdictions
 - 3.2.15 Ongoing training and the upkeep of SAR skills has been identified as a problem affecting all SAR Authorities. Each authority is responsible for maintaining a program that ensures SAR skills and knowledge are kept at a high level. It has been identified that merely coordinating SAR incidents does not constitute skills maintenance as coordinators slowly become complaisant and take short cuts. Good results may be often due to luck rather than good planning. Various Coroners' Courts have identified many SAR incidents that have failed due to poor or non-existent planning. Regular training exercises and practical tests that encourage the use of correct methods should be undertaken on an annual or biannual basis.

3.3 Search and Rescue Exercises

- 3.3.1 Exercises test and improve operational plans, provide learning experience and improve liaison and coordination skills. Exercises, conducted on a realistic basis, help to demonstrate and assess the true effectiveness of training and the operational efficiency and competence of the SAR service. Exercises will reveal deficiencies that may exist in SAR plans and enable them to be improved. It is safer to have shortcomings revealed by exercises rather than during actual operations.
- 3.3.2 Each search and rescue authority should periodically take part in coordinated search and rescue exercises (SAREX). These SAREXs should be designed to exercise the SAR system, in whole or part, and test such things as operational plans, communication procedures and facilities, individual staff performance, SAR assets performance and inter-organisation and/or international operations.
- 3.3.3 It is equally important that personnel have a good knowledge of the duties and procedures of other assets and person who may be involved in a SAR operation, particularly those with whom they will have direct contact. It is especially important that SMCs be aware of the time, effort, and risk involved when requests are made to other assets or organisations.
- 3.3.4 The regular conduct of joint SAREXs between SAR Authorities should form a part of any training program.
- 3.3.5 Emergency Management Australia (EMA) has developed a handbook, "Managing Exercises" that is [Handbook 3](#) of the Australian Emergency Management Handbook and Manual Series. This manual should be used as a guide and to assist SAR personnel designing and conducting search and rescue exercises. This Handbook and other EMA publications can be found on the Australian Institute for Disaster Resilience website at <https://aidr.infoservices.com.au/collections/handbook>.

3.4 Training of Search and Rescue Assets

Land SAR Training

- 3.4.1 Land SAR training is generally conducted by State/Territory Police organisations, with assistance from members of the State and Territory Emergency Services
- 3.4.2 Other SAR authorities that may become involved in a land SAR incident should ensure that their members are familiar with police arrangements for alerting and dispatching of rescue assets.

Search and Rescue Crew Training

- 3.4.3 SAR Authorities should coordinate SAR exercises in conjunction with search and rescue crews to ensure practice is maintained in techniques employed in SAR operations.

Dropmaster and Dispatchers

- 3.4.4 The dispatch of survival stores and equipment from an aircraft to survivors on land or over water is an exacting task, which, if not performed well, can nullify or seriously delay the rescue effort and may endanger the aircraft and its crew.
- 3.4.5 Supply dropping operations by civil aircraft should only be carried out by personnel trained in the preparation and delivery of droppable equipment in accordance with CASA regulations.
- 3.4.6 Joint exercises involving all authorities that organise or participate in land rescue should be arranged on a periodic basis.

Air Observer Training

- 3.4.7 Major SAR operations require a considerable number of observers who may be drawn from various organisations.
- 3.4.8 JRCC Australia has published a comprehensive handbook for Observers that is available to all SAR Authorities from the SAR Resources and Training section of AMSA.
- 3.4.9 Observer leaders, observer briefing check lists, aircraft observer instructions and observers on ships are discussed in detail in Volume 1, Chapter 2.2.12.

Aviation Search and Rescue Assets (SRA)

- 3.4.10 JRCC Australia provides training to contracted aircraft operators who are considered suitable and capable of providing a SAR response.
- 3.4.11 These operators once formally trained and equipped are provided with appropriate continuation training and are known operationally as civil SRAs. The scope of training provided is specific to the resource capability of individual operators, in terms of human resources and aircraft availability.
- 3.4.12 Accordingly, operators are given training in one or more of the following aspects of SAR operations:
 - a) Visual search procedures/techniques;
 - b) Airborne location of distress beacons using aural homing techniques;
 - c) Airborne location of distress beacons using DF equipment;
 - d) On ground location of localised distress beacons;
 - e) Operation of electronic sensor systems in SAR operations;
 - f) Aerial delivery of supplies/equipment overland and/or over water; and
 - g) Helicopter rescue techniques.

First Aid Training

- 3.4.13 All personnel involved in SAR need to be trained in basic first aid. JRCC, ADF and State/Territory have first aid training capabilities, via their State/Territory Ambulance Services, St John's Ambulance or private providers. While all personnel should have a basic first aid knowledge, at least one member of each search team should be qualified to a higher level of training, Senior First Aid or First Response First Aid. Regular training needs to be carried out to instil confidence in the delivery of first aid in remote situations.
- 3.4.14 First Aid: Adequate training in first aid is available through organisations such as the St. John Ambulance, Red Cross, or other recognised providers.

Map Reading and Navigation

- 3.4.15 Training is to be in accordance with the established map/chart reading plans for each State/Territory. The World Geodetic System (WGS) is a standard for use in cartography, geodesy, and navigation worldwide. It is the reference coordinate system used by the Global Positioning

System (GPS). WGS standardises the Earth as a spheroid with its accompanying coordinate framework. The Australian Geodetic Datum (AGD), both the 1966 and 1984 versions, has been replaced by Geocentric Datum of Australia (GDA94). Therefore, for all practical purposes, the GDA is fully compatible with WGS84 and ITRF92 in terms of spheroid and datum. The National Mapping Council adopted the use of GDA94 from the 1st January, 2000, ensuring a homogeneous GDA, as opposed to the AGD66 or AGD84 in all States and Territories.

- 3.4.16 Training in map/chart usage is to be based on a combination of manual/historical methods and electronic methods to ensure an all-round capability.

Radio Operating Procedures

- 3.4.17 Training is to be in accordance with established standards within the JRCC, ADF and State/Territory and the Australian Emergency Manual—Communications.

Field craft

- 3.4.18 Field craft is a broad subject which is difficult to define in its entirety. It is a series of practical skills which can only be taught in the field. The aspects of field craft which are important to the searcher are:
- a) Searching ground by eye;
 - b) Judging distance;
 - c) Basic tracking; and
 - d) Living in the bush.

Observation Skills

- 3.4.19 Observation is the skill of looking for clues and may be required to be conducted by day or night. The principles of clue recognition and interpretation are shown as Appendix E-13 to this Manual.

Observation Skills-Day

- 3.4.20 Observation Skills – Day: The ability to ‘see’ rather than just look, may need to be taught when operating in the unfamiliar bush environment, and observing changes and noting details are skills which must be developed in most people. To understand why things are seen, it must be explained that several factors are involved which aid this process:
- a) Shape—regular shapes do not occur in nature.
 - b) Shine—rarely do natural things shine.
 - c) Shadow—unusual shadows will often reveal what may appear to be hidden.
 - d) Movement—immediately attracts the eye.
 - e) Colour—differences to the natural background are obvious to the trained eye.
 - f) Spacing—regular spacing does not occur in nature.
- 3.4.21 These factors are best demonstrated in a bush environment, and with a better understanding of them, the searcher will become a better observer.
- 3.4.22 Observation Skills – Night: Due to the physical characteristics of the eye, if an observer looks directly at a small or dim object at night, it may not be seen. To optimise night vision objects should be observed ‘off centre’:
- a) Off Centre (Averted Vision): To achieve ‘off centre’ vision, the eye should be ‘aimed off’ from the object about a fist’s width at arm’s length. Only by experiment can the searcher find out which direction is most suitable for their aim off i.e. above, below or to one side of the object. It is important that the searcher resist the temptation to look directly at the object.
 - b) Scanning: Scanning is the short, abrupt movement of the eye over or around an area of observation or an object that is being kept in view. It is used in conjunction with off centre

vision in order to gain the maximum use of the eyes at night. Therefore, the observer should move their visual axis every 4–10 seconds. Night scanning differs from day-time scanning. Should the day-time technique of looking from left to right in overlapping parallel bands from near to far be used, then nothing would be seen.

- c) Staring: It is important to realise that when staring at a stationary light or prominent object in an otherwise black scene, the object may start moving. This happens because the eye has no bearing on which to check the exact position. This can be prevented by ‘placing’ the object against something else such as a finger at arm’s length.
- d) Confidence: In order to gain confidence in the ability to see under low light levels, the correct use must be made of the eyes. Objects seen at night tend to be fuzzy and hazy around their extremities. Through practice, an observer must learn to recognise objects at night and how they differ from their day-time appearance. Once a searcher is familiar with the techniques of seeing at night, the confidence necessary for night operations will quickly follow.
- e) Protection of Night Vision: Any bright light will spoil night vision. It is important that the searcher instinctively closes, or covers one eye when faced with any light at night. In addition they should:
 - i) Avoid looking at any bright light unnecessarily;
 - ii) Shield the eyes with their hand from flares, spotlights or headlights (by so doing it is possible to see objects moving beyond the lights and it also protects the night vision);
 - iii) Avoid waving torches about as not everybody will be quick enough to close their eyes in order to avoid being dazzled;
 - iv) Put one hand over the glass when using torches to map read, and use the fingers to limit both the area illuminated and the brightness of the light (keep one eye shut and the time spent on reading the map to a minimum); and
 - v) Use of coloured filters on torches will assist in maintaining night vision although similar coloured markings on maps cannot be seen.

3.4.23 Search Techniques: Training in search techniques is to be in accordance with Volume 2, Chapter 4 of this Manual.

Team and Individual Skills

3.4.24 Whilst the ability to ‘see’ in the SAR environment is probably the most important skill for a member of a search team, there are a number of other skills in which the searcher must be trained if they are to operate successfully. In addition, individuals must train together to increase their effectiveness as a team. The Team Leader is responsible for continuous training of the team to ensure that they will be capable of searching effectively. Much of this training only comes with regular practice and cannot be gained in one annual search exercise.

3.4.25 Each individual search team member must receive training in:

- a) Map/chart reading and navigation;
- b) Radio operating procedures;
- c) Basic first aid;
- d) Field craft/seamanship;
- e) Observation; and
- f) Search techniques.

3.4.26 To ensure success, it is necessary to train as a team, even if all the individual training has been undertaken.

Searchers

- 3.4.27 All persons involved in searches need specific skills, attributes, equipment and both physical and mental capabilities:
- a) Attitude - Must be psychologically prepared for both the rigours of the search operation and for the possibility of locating a seriously injured or deceased person.
 - b) Personal Equipment - Each searcher must be self-sufficient in personal equipment. Such equipment should be capable of being carried on the person, in pockets or on a belt. The carriage of excess equipment should be avoided as searchers must remain highly mobile. Suggested items include:
 - i) Clothing and footwear appropriate to the weather and the environment;
 - ii) Appropriate headgear;
 - iii) Filled water bottles;
 - iv) Pocket knife and whistle;
 - v) Notebook and pen;
 - vi) Compass and map (if required);
 - vii) Snacks and nibbles;
 - viii) Sun cream, insect repellent etc.; and
 - ix) Minor personal first aid items.
 - c) Readiness—A readiness for the search including:
 - i) Commitment to the task;
 - ii) Time commitment for the entire search rather than small segments of it;
 - iii) Discipline and teamwork; and
 - iv) Acceptance of hardships.
 - d) Fitness—Searchers must be sufficiently fit to cope with the physical demands for the search activity.

Search Team Leaders/On-Scene Commanders

- 3.4.28 The Search Team Leader/On-Scene Commander (STL/OSC) is the vital link between the SMC and the search team. The leader must be highly trained and motivated with the experience and background knowledge which is necessary to successfully lead the team in the field. This can only be gained by constant training under realistic conditions.
- 3.4.29 Desirable Qualities: Searches involve people, therefore it is essential that the STL/OSC has the knowledge, experience and personality to effectively lead and control the team. They must be an effective manager, must be aware of the capabilities of the team, have an understanding of each member's limitations and have their general well-being in mind. There is a need for adequate rest, food and shelter during operations and the STL/OSC must ensure that this is provided.
- 3.4.30 The attributes of a STL/OSC include:
- a) Leadership skills;
 - b) Dedication;
 - c) Knowledge; and
 - d) Flexibility.
- 3.4.31 The main skills for a STL/OSC are as follows:
- a) Orders - The ability to give clear, concise and detailed orders;
 - b) Map/chart Reading and Navigation - The ability to read a map/chart and navigate in a variety of environmental conditions;
 - c) Use of Radios - Use a radio, pass messages and use the terrain to best effect;

-
- d) Casualty Handling - They must have a sound knowledge of first aid and casualty handling procedures;
 - e) Field craft/seamanship - Must be skilled in living, navigating and operating in the field or at sea as appropriate; and
 - f) Search Techniques - Must be competent in the implementation of all appropriate search techniques.

3.5 Photographic Records

- 3.5.1 Where possible, photographic or video recordings should be taken on exercises and actual SAR missions for use as future training aids. Participating authorities' film crews may be helpful in providing this facility.

3.6 Liaison Visits

- 3.6.1 It is important that personnel have a good knowledge of the duties and procedures of other assets and persons who may be involved in SAR operations, particularly those with whom they will have direct contact. It is especially important that SMCs be aware of the time, effort and risk involved when requests are made to other assets or persons.
- 3.6.2 Liaison visits between personnel likely to become involved together in SAR operations are encouraged. SMCs should inspect other assets' facilities and where possible take part in appropriate activities, e.g. packing and loading equipment, helicopter rescue exercises, etc. The personnel of other organisations or assets should be encouraged to visit RCCs and other SAR related assets. Potential SAR team members, either assets or individuals, should be invited to participate in, or attend exercise.

This page has intentionally been left blank

Volume 2- Search and Rescue Operations

NATIONAL SEARCH AND RESCUE MANUAL

2023 EDITION Version 1 – February 2023

Chapter 1 Communications

1.1 Aviation and Maritime

Overview

- 1.1.1 Distress traffic includes all messages relating to immediate assistance required by persons, aircraft, or marine craft in distress, including medical assistance. Distress traffic may also include SAR communications and on-scene communications. Distress calls take absolute priority over all other transmissions; anyone receiving a distress call must immediately cease any transmissions that may interfere with the call and listen on the frequency used for the call.
- 1.1.2 Distress and safety communications require the highest possible integrity and protection from harmful interference. Any interference that puts at risk the operation of safety services degrades, obstructs or interrupts any radio communications, is harmful. Some frequencies are protected, in that they have no authorised uses other than for distress and safety. SAR personnel should be particularly careful not to cause harmful interference, and should co-operate with authorities to report and stop incidents of interference.
- 1.1.1 The object of search and rescue (SAR) communications is to make possible the conduct of SAR operations. As per Regulation 7 of Chapter V of SOLAS, arrangements have been established to facilitate distress communication and co-ordination within the Australian SRR. Such communications must allow for:
- Rapid transmission of distress messages from aircraft, ships, small marine craft and persons, including for medical assistance;
 - Rapid communication of distress information to the authorities responsible for organising and effecting rescue;
 - Coordination of the operation of the various SAR assets; and
 - Liaison between controlling/coordinating authorities and SAR assets.

1.2 Distress and Emergency Signals

- 1.2.1 There are many signals that can be used to indicate a distress or other emergency.
- 1.2.2 Personnel involved in SAR operations must be familiar with the types of signals they can expect to encounter in order to evaluate their meaning correctly and take appropriate action.
- 1.2.3 These emergency signals may be made by radio, satellite, telephone, texting, internet (email, social media, etc.). RADAR (e.g. transponders), flags, pyrotechnics, flashing lights, smoke, sounds, shapes and ground panels. (Appendix D-1 lists the more common signals and terminology in use.)

Maritime Radio Alarm Signal

- 1.2.4 With the full implementation of the Global Maritime Distress and Safety System (GMDSS) in February 1999 the automatic alarm devices used on 2182 kHz are no longer required. However, some maritime communication stations may still use the voice alarm signal consisting of two sinusoidal audio frequency tones, one of 2200 Hz and the other of 1300 Hz, producing a distinct warbling sound to draw attention to a distress broadcast. Merchant shipping complying with the SOLAS Convention now guard the Digital Selective Calling (DSC) distress frequencies.

Radiotelephone Distress Signal

- 1.2.5 The distress signal “MAYDAY, MAYDAY, MAYDAY” is used to indicate that a ship, aircraft or other vehicle is threatened by grave or imminent danger and requires immediate assistance. Distress calls, distress messages and distress traffic have priority of communications over all other communications.

Radiotelephone Urgency Signal

- 1.2.6 The urgency signal “PAN PAN, PAN PAN, PAN PAN” is used to indicate that the calling station has a very urgent message to transmit concerning the safety of a ship, aircraft or other vehicle or a person. It has priority communications over all other communications, except distress calls, distress messages and distress traffic.

Radiotelephone Safety Signal

- 1.2.7 The safety signal “SECURITÉ” indicates that the station is about to transmit a message concerning the safety of navigation or providing an important meteorological warning. The safety message is preceded by the word ‘SECURITÉ’ spoken three times.
- 1.2.8 All stations hearing a distress, urgency or safety signal shall not make any transmissions that might interfere with those signals and be ready to copy any message that follows.

Radiotelephony Distress/Emergency Frequencies

- 1.2.9 The following frequencies have been designated as distress or emergency frequencies.

GMDSS Distress, Urgency, Safety and Calling Frequencies

Radio Telephone	DSC	NBDP
2182	2187.5	2174.5
4125	4207.5	4177.5
6215	6312.0	6268.0
8291	8414.5	8376.5
12 290*	12 577.0	12 520.0
16 420*	16 804.5	16 695.0
VHF: Ch. 16	VHF: Ch. 70	VHF not used

Note: None of the MF/HF DSC or NBDP frequencies are used when calling. The AMSA HF DSC network monitors DSC in the 4 – 16 MHz bands.

* The frequencies 12 290 kHz and 16 420 kHz be used only for distress, urgency and safety communications, and safety-related calling limited to that, to and from rescue coordination centres.

2182 kHz

- 1.2.10 The international MF voice distress frequency primarily for ship-to-ship communications, the upper side band 2182 kHz is used for follow-on communications after an initial DSC distress alert on 2187.5 kHz for GMDSS shipping. In Australia, some Limited Coast Radio Stations operated by Volunteer Marine Rescue (VMR) Groups around the coast advertise the monitoring of the 2182 frequency. Contact the local VMR Unit to ascertain its monitoring of 2182. The two-tone alarm may still be used on 2182 kHz to draw attention but auto alarms are no longer a part of the Radio Regulations.

4125, 6215, 8291, 12290 and 16420 kHz

- 1.2.11 These frequencies have been authorised for common use by ships and coast stations using the HF frequencies for upper sideband radiotelephony on a simplex basis for calling, reply and safety purposes. The frequencies quoted are the carrier frequencies. The State and Territory Coast Radio Stations monitor the distress and safety frequencies in the 4, 6 and 8 kHz bands.

121.5 MHz

- 1.2.12 The international aeronautical emergency frequency for aircraft and those aeronautical stations primarily concerned with the safety and regularity of flight and having equipment in the 118-136 MHz VHF band.
- 1.2.13 Ships fitted with the capability are authorised to communicate on this frequency with aircraft for safety purposes.

156.8 MHz (Marine VHF Channel)

- 1.2.14 The international distress, safety and calling frequency for radiotelephony stations of the maritime mobile service, when using frequencies in the Marine VHF bands 156 to 174 MHz
- 1.2.15 State and Territory limited coast radio stations, port authorities, merchant ships, fishing craft and pleasure craft use VHF Ch. 16.
- 1.2.16 Merchant ships maintain a continuous bridge listening watch on VHF channel 16 to the maximum extent practicable when at sea; and is monitored in all active marine rescue bases (e.g. Marine Rescue NSW monitor VHF Ch. 16).
- 1.2.17 156.3 MHz (Marine VHF Channel 6) is used for coordination at the scene of an incident.

243 MHz

- 1.2.18 243 MHz is the international military aeronautical emergency frequency.

Safety Frequencies

- 1.2.19 The following table indicates Safety frequencies in use in Australia.

156.375 MHz	VHF FM RTF (Marine channel 67)	Marine safety: Australia only (supplementary to Channel 16 and used to broadcast weather and warnings from State/Territory limited coast stations)
27.88 MHz (Channel 88)	HF (Marine) RTF	27 MHz band, pleasure craft safety frequency (in Australia) 27.88 MHz has been overtaken in popularity by VHF 16 by the general public.
2524 kHz	MF (Marine) RTF	Pleasure boat safety, volunteer SAR organisations (in Australia)

1.3 Global Maritime Distress and Safety System (GMDSS)

- 1.3.1 Ships subject to the Safety of Life at Sea (SOLAS) Convention are obliged to be outfitted with certain communications equipment to participate in the Global Maritime Distress and a Safety System (GMDSS). Fishing vessels and small craft around Australia, if carrying compatible GMDSS equipment can also participate.
- 1.3.2 AMSA is responsible for the provision of shore facilities for the GMDSS and all distress and safety traffic through the GMDSS shore infrastructure in the Australian SRR will be handled by JRCC Australia.

-
- 1.3.3 Ships operating under GMDSS requirements in the Australian SRR can be expected to carry:
- a) MF DSC;
 - b) VHF radiotelephone (Channels 6, 13, 16 and 67);
 - c) VHF DSC (Channel 70);
 - d) HF DSC or a ship earth station of a recognised mobile satellite service;
 - e) An AIS-SART or RADAR SART; and
 - f) An EPIRB.

1.4 Emergency Signalling Devices

- 1.4.1 People in distress may use any possible means of alerting others to their situation. These devices range from emergency radio beacons to mirrors.

Daylight Devices

- 1.4.2 Reflective mirrors (heliographs), used by survivors to reflect the sun's rays towards a SAR asset, are an effective daylight device. Mirrors have been detected as far away as 80 kilometres (45 miles) and from as high as 10,000 feet, although the average distance is about 18 kilometres (10 miles). Fluorescent material (known as retro-reflective tape) that reflects a large percentage of sunlight is usually sewn on one side of lifesaving craft coverings and has been detected as far away as 9 kilometres (5 miles) with an average of 6 kilometres (3.5 miles).
- 1.4.3 Fluorescent sea dye marker, which stains the water a green or red colour, has been sighted as far away as 18 Kilometres (10 miles), with an average of 5 kilometres (3 miles). However, sea dye is not visible when searching up-sun because of surface glare.
- 1.4.4 Orange smoke generating signals have been sighted as far away as 20 kilometres (12 miles) with an average of 14 kilometres (8 miles). Smoke signals are most effective in calm wind conditions and open terrain. The effectiveness of smoke signals decreases rapidly with an increase of wind speed above 15 knots (25 kph).
- 1.4.5 Pyrotechnic flares may be used in daylight; however their detectable range is only about 10 per cent of the night-time range.

Night Vision Imaging Systems (NVIS) for aviation searching

- 1.4.6 NVIS incorporates all aspects associated with night vision including Night Vision Goggles (NVGs) and Night Vision Devices (NVDs).
- 1.4.7 With the use of NVIS, objects emitting small amounts of light such as mobile telephone screens are able to be seen from great distances. There is no need for a telephone signal, it is the lit screen that is being detected. Larger light sources such as fires, torches, and strobe lights can be viewed from considerably farther. E-Flares and some LED strobe lights have been identified as being invisible on NVIS due to the frequencies used. Searchers must be aware of this.
- 1.4.8 Appendix F Aircraft Electronic Night Search Guidance contains more details on using NVIS for searching by aircraft.
- 1.4.9 On land, fires are arguably the most effective night time signal that survivors may use. Fires have been sighted as far as 90 kilometres (50 miles) away, with the average range varying with the size of the fire, the absence of other light sources on the earth's surface, the terrain and Height of Eye of the search asset.
- 1.4.10 Flashing strobe lights are an effective compact night signalling device available for individual survivors. Strobe lights have been sighted as far as 35 kilometres (20 miles) away with an average of 6 kilometres (3.5 miles).

-
- 1.4.11 Incandescent lights that are used on some individual lifejackets have a much smaller detectable range than strobe lights, generally about 1 kilometre (0.5 mile).
 - 1.4.12 Flares, star shells and rockets have been detected as far away as 60 kilometres (35 miles), with an average of 45 kilometres (25 miles) from the air.
 - 1.4.13 With the use of Night Vision Goggles (NVG) objects emitting small amounts of light such as mobile telephone screens are able to be seen from great distances. There is no need for a telephone signal, it is the lit screen that is being detected. Larger light sources such as fires, torches, and strobe lights can be viewed from considerably farther. E-Flares and some LED strobe lights have been identified as being invisible on NVG due to the frequencies used. Searchers must be aware of this.

RADAR/IFF/SSR

- 1.4.14 Besides the obvious RADAR target of the distressed target itself, IFF (Identification Friend or Foe) may be used not only to indicate distress but also to increase the detectable range by RADAR.
- 1.4.15 The basic equipment consists of an interrogator and a transponder. The interrogator, which is usually incorporated into air search RADAR systems, transmits electronic challenges, and if any replies are received will display them on the Radarscope. The transponder, which is usually installed in aircraft, ships and boats, is triggered into operation by the interrogator's challenge and transmits a series of pulses. The reply is displayed as small bars slightly beyond the RADAR target of the transponder-equipped target. Since interrogators usually use the same antenna as the air search RADAR, replies are only received as the search RADAR beam sweeps across the transponder-equipped target. In addition, transponder replies will be detected at much greater ranges than the RADAR return from the target itself.
- 1.4.16 Secondary Surveillance RADAR (SSR) is the name used to describe similar equipment in use by Airservices Australia and civil aircraft. Military mode 3 is the same as civil mode A and thus the systems are compatible for air traffic control and emergency purposes. Military mode 3, code 7700 and civil mode A, code 7700 transmits an emergency signal and, unless amplified by additional information, will be considered as a distress signal.

Radio and Distress Beacons

- 1.4.17 In addition to the obvious uses of standard radio for transmitting emergency signals and messages, there are a variety of types of emergency equipment designed for use by survivors or carried in the vessel's wheelhouse. These include:
 - a) Hand held VHF transmitters found in life rafts;
 - b) 406 MHz distress beacons (GMDSS approved); An AIS-SART; and
 - c) 9 GHz SAR Transponders.

1.5 COSPAS-SARSAT Distress Beacon Detection System

Overview

- 1.5.1 COSPAS-SARSAT is a satellite system designed to provide distress alert and location data to assist SAR operations, using spacecraft and ground facilities to detect and locate the signals of distress beacons operating on 406 MHz. The responsible COSPAS-SARSAT Mission Control Centre (MCC) forwards the position of the distress and other related information to the appropriate SAR authorities. Its objective is to support all organisations in the world with responsibility for SAR operations, whether at sea, in the air or on land.
- 1.5.2 The COSPAS-SARSAT System provides distress alert and location data to RCCs for 406 MHz beacons activated anywhere in the world. In the Australia/New Zealand region, the Australian Mission Control Centre (AUMCC) is managed by AMSA and processes data collected by satellite tracking stations in Australia and New Zealand. COSPAS-SARSAT

Purpose

- 1.5.3 The primary purpose of this system is to detect, positively identify and provide the positions of 406 MHz EPIRBs, ELTs and PLBs anywhere in the world.
- 1.5.4 The worldwide system comprises:
- a) Low-altitude Earth orbiting satellites in near polar orbits known as LEOSAR satellites;
 - b) Satellites in geostationary orbit known as GEOSAR satellites;
 - c) Satellites in medium-altitude Earth orbit known as MEOSAR satellites;
 - d) Local User Terminals (LUTs) are ground stations that receive and initially process the raw distress signal data relayed by a satellite;
 - e) Mission Control Centres (MCCs) which are responsible for the final processing and appropriate distribution of beacon detections; and
 - f) Frequency stable 406 MHz beacons, each with a unique identification code and capable of transmitting for 24 or 48 hours depending on their use.

Satellites

- 1.5.5 The COSPAS-SARSAT system uses three search and rescue satellite constellations: LEOSAR, GEOSAR and MEOSAR.
- 1.5.6 Each LEOSAR satellite makes a complete orbit of the earth around the poles in about 100 – 105 minutes. The satellite views a "swath" of the earth of approximately 4000 km wide as it circles the globe, giving an instantaneous "field of view" about the size of a continent. When viewed from the earth, the satellite crosses the sky in about 15 minutes, depending on the maximum elevation angle of the particular pass.
- 1.5.7 LEOSAR satellites are not equally spaced and hence do not pass over a particular place at regular intervals. In view of this, pass schedules are computed for each LUT every day. On average a satellite will pass over continental Australia every 90 minutes but, because of the irregularity of passes, there could be up to five (5) hours between passes.
- 1.5.8 The current GEOSAR constellation is composed of satellites provided by the USA, India, Russia and Europe. These satellites provide continuous global coverage for 406 MHz beacons with the exception of the Polar Regions.
- 1.5.9 As the GEOSAR satellites appear stationary from Earth, if the direct line of sight from the beacon to the GEOSAR satellite is blocked (for example, by terrain such as a mountain, called shadowing), the beacon will not be detected by the GEOSAR satellite.
- 1.5.10 The MEOSAR satellites consist of satellites provided by the United States, the Russian Federation and the European Union. The full MEOSAR constellation will have about 72 satellites. These MEOSAR satellites orbit the Earth at altitudes between 19,000 and 24,000 km, a range considered as a medium-altitude Earth orbit. The footprint of a MEOSAR satellite is between 12000 and 13000 km and the satellites provide continuous global coverage of the Earth. These satellites send the beacon message back to earth where it is detected by a MEOLUT (MEOSAR Local User Terminal). With sufficient information, the MEOLUT will generate a location for the distress beacon. The beacon activation information is forwarded to a Mission Control Centre (MCC) and then to the relevant Rescue Coordination Centre (RCC) which responds to the beacon activation. The MEOSAR system will detect beacons in almost real-time (i.e. within 5 minutes). If the beacon is detected by three or more MEOSAR satellites, then the location of the beacon will be determined as well. When the full constellation of MEOSAR satellites is in operation, this will mean location will be determined within 10 minutes, 95 percent of the time.

Beacon Detection

- 1.5.11 A LUT tracking LEOSAR satellites is known as a LEOLUT. A LEOLUT generates the position of a distress beacon using Doppler shift, which is caused by the relative movement between a satellite and a beacon. As a satellite approaches a beacon there is an apparent rise in the beacon frequency and as the satellite moves away the frequency appears to fall. When a satellite is at its closest point to a beacon the received frequency is the same as the transmitted frequency (the point of inflection) and provides the “Time of Closest Approach” (TCA).
- 1.5.12 This method of calculation produces two possible positions for each beacon (labelled A and B), either side of the satellite’s ground track; one is the true position and the other is its mirror image. The ambiguity is due to the equipment only being able to determine the distance between a satellite and a beacon and not the direction. Position ambiguity is subsequently resolved by using other independent location data (for example; an encoded location or data from another LEOSAR satellite pass).
- 1.5.13 A LUT tracking MEOSAR satellites is known as a MEOLUT. A MEOLUT generates the position of a distress beacon using DOA (Difference of Arrival) processing. Upon receiving a transmission (a beacon burst) from a 406 MHz distress beacon via a MEOSAR satellite, a MEOLUT will generally measure two key values: the Time of Arrival (TOA) and the Frequency of Arrival (FOA). Assuming reception of a beacon transmission through at least three distinct MEOSAR satellites, MEOLUT processing can provide a two-dimensional (longitude and latitude) beacon location using a combination of time difference of arrival (TDOA) and frequency difference of arrival (FDOA) computations. The location computed by a MEOLUT is known as a difference of arrival (DOA) location. Three-dimensional locations (i.e., with the addition of a computed altitude) are possible when the beacon burst is relayed to a MEOLUT via four or more MEOSAR satellites.
- 1.5.14 A GEOLUT is only able to detect a beacon within its footprint but not at the poles, and cannot generate a location for the beacon unless the beacon transmits an encoded location.

Beacons

- 1.5.15 There are three types of COSPAS-SARSAT distress beacons:
- a) Emergency Locator Transmitters (ELT) used by aviators (generally larger devices mounted in the tail of an aircraft);
 - b) Emergency Position Indicating Radio Beacons (EPIRB) used by mariners (waterproof and required to float upright); and
 - c) Personal Locator Beacons (PLB) used on land (initially not required to be waterproof or buoyant [floatable] but new generation ones are becoming so.).
- 1.5.16 A distress beacon with GNSS (Global Navigation Satellite System, also known as a GPS) capability is able to transmit an encoded location as part of its beacon message. There are two mechanisms used to derive the GNSS location: either the distress beacon has an internal GNSS receiver or the distress beacon receives the GNSS data from an external device that connects to the beacon. Due to the popularity of the GPS system, the encoded location is often known as the GPS location of the beacon.
- 1.5.17 Aviators and mariners often carry PLBs as personal back up devices to ELTs and EPIRBs.
- 1.5.18 Because 406 MHz beacons transmit an extremely stable frequency, positions calculated by the LUT usually fall within a radius of 5km from the actual beacon position. All 406 MHz beacons sold in the Australian region are required to transmit on a side frequency of 121.5 MHz to facilitate homing.
- 1.5.19 406 MHz beacons use digital technology that allows an identifier to be sent when the beacon is activated. This identifier correlates to a registration database held at the JRCC and allows additional information to be gained about the target. 406 MHz beacons should be coded with a

country code and registered in the country that maintains the database for that country code. It is therefore important that all Australian 406 MHz beacons are registered with JRCC Australia.

- 1.5.20 If an Australian beacon is detected overseas, the overseas SAR authority may contact JRCC Australia for appropriate details. Similarly, if a foreign-registered 406 MHz beacon is detected in the Australian SAR area, JRCC Australia contacts the appropriate overseas registration authority to obtain further relevant SAR data.
- 1.5.21 Satellites processing of 121.5 MHz alerts ceased on 1 February 2009, from 1 February 2010, old analogue EPIRBs and PLBs operating on the 121.5 MHz frequency are no longer licensed for use.

1.6 Other Types of Distress Alerting Devices

- 1.6.1 Advances in technology have seen the development of satellite tracking devices.

SPOT Personal Satellite Messenger device (SPOT)

- 1.6.2 The SPOT device and its associated service originate from a USA company called SPOT LLC. SPOT is primarily a tracking device which can also send preformatted messages indicating that a person is safe or that they require non-emergency assistance. In addition the user is able to alert an Alerting Post that they are in distress. SPOT LLC has contracted for the provision of 24-hour emergency monitoring and response to SPOT users through the International Emergency Response Coordination Centre (IERCC), an Alerting Post located in the United States of America. These devices operate on cellular or satellite telephone networks and are therefore vulnerable to coverage limitations. The devices offer a range of functions which may be more attractive to a hiker or bushwalker than a COSPAS-SARSAT approved device but there are limitations to the devices that could hamper a search and rescue effort.

Note: A Memorandum of Understanding has been reached between AMSA and the IERCC regarding the handling of SPOT-initiated distress alerts. The IERCC will notify JRCC Australia of any distress alerts within the Australian SRR. JRCC Australia will then coordinate any SAR response required or transfer coordination to another Australian SAR authority where appropriate.

AIS-SART

- 1.6.3 The AIS-SART derives position and time synchronization from a built in GNSS receiver and transmits its position with an update rate of one (1) minute. Every minute the position is sent as a series of eight (8) equal position reports, this is to maintain a high probability that at least one of the position reports is sent on the highest point of a wave.
- 1.6.4 Shipboard Global Maritime Distress Safety System (GMDSS) installations include one or more search and rescue locating devices. These devices may be either an AIS-(AIS Search and Rescue Transmitter SART) (from 1 January 2010), or a RADAR-SART (Search and Rescue Transponder). The AIS-SART is used to locate a survival craft or distressed vessel by sending updated position reports using a standard AIS class (A) position report. The position and time synchronization of the AIS-SART is derived from a built in Global Navigation Satellite Systems GNSS receiver.

Maritime Survivor Locating Systems. VHF DSC Maritime Survivor Locating Devices (MSLD).

- 1.6.5 The VHF DSC MSLD, such as the Mobilarm Crewsafe series of beacons, transmit a MAYDAY using a synthesised voice on VHF Channel 16 and a distress alert on DSC (VHF Channel 70) immediately a man overboard incident occurs (or when the unit is manually activated), this is repeated once the MSLD obtains a GPS position (within 1 minute) and is updated every 5 minutes for the first 30 minutes, and then every 10 minutes for the life of the battery (24 hrs). The MSLD includes the MMSI for identification; some MSLD may also transmit on AIS and a 121.5 MHz homing signal.

Thuraya Satellite Devices

- 1.6.6 The Thuraya Telecommunications Company (“Thuraya”) runs and operates the Thuraya Satellite Network to provide telecommunications products and services in the coverage area of the Thuraya Satellite System. Thuraya devices have the capability to provide distress alerting function to subscribers. The Thuraya subscriber will initiate an emergency call by pressing and holding a “special button” or activating a special function on the Thuraya device. The device will then obtain a GPS fix and send the location and event request via the Thuraya satellite system.
- 1.6.7 For the Australian SRR, Thuraya is responsible for immediately notifying JRCC Australia of the emergency assistance request (distress alert) for necessary support and action. JRCC Australia is the sole Australian point of contact for Thuraya unless agreed by the Parties for the distress alert to be sent to another location. Furthermore, the subscriber may program their unit to send the same alert to other destinations in addition to JRCC Australia.
- 1.6.8 In accordance with the Australian National SAR Plan, overall coordination of a SAR operation may be transferred from JRCC Australia to an Australian State or Territory Police force or service. In such circumstances, JRCC Australia will inform Thuraya of the transfer of overall coordination.

Note: There is an MOU in place between AMSA (JRCC Australia) and Thuraya Telecommunications Company regarding the above.

1.7 SAR RADAR Transponder (SART)

Overview

- 1.7.1 Satellites can detect and provide the positions of the latest distress beacons to an accuracy of a few miles/kilometres. Though this is extremely good, in poor visibility it may not be sufficient to permit a searching craft to quickly locate survivors. To overcome this problem, a SAR transponder (SART) has been developed which will respond to the normal 3cm X-band (9 GHz) RADAR fitted to merchant ships. It will NOT respond to 10cm S-band (3 GHz) RADAR. It is a short-range homing device, which enables ships and other suitably equipped craft to home on the source of the signal. This facility is in accordance with IMO Resolution A. 530(13) - Use of RADAR transponders for search and rescue purposes.
- 1.7.2 The SART can be either a stand-alone item of equipment or built into an EPIRB.
- 1.7.3 When within RADAR range, the SART will respond to 3cm RADAR pulses by painting a line of blips extending outwards from the SART’s position along its line of bearing on the RADAR screen. When within about one (1) mile of the SART, the blips may change to wide arcs or even complete circles thus giving an indication of the close proximity of the SART, but masking its bearing. Decreasing the GAIN on the search craft’s RADAR should restore the blips to view.



Diagram 1-1 Images projected onto a radar screen by a SART

- 1.7.4 Since the RADAR detection range depends primarily upon the height of the RADAR scanner and the height of the beacon, it is probably not realistic to expect a detection range of much more than 30 miles (55km) for an aircraft flying at 3000 ft. equipped with 3cm (9 GHz) RADAR and about 10 miles (18km) for a ship’s RADAR and a few miles (3km) for a motor launch. However, bearing in mind that it is a short-range homing device, this should be adequate for final location.
- 1.7.5 Tests have shown that the operation of a SART inside the canopy of a life raft will significantly decrease its detection range, so every effort should be made to operate it from outside the

canopy and as high as possible. Battery life in the “standby” mode is 96 hours and about eight (8) hours during RADAR interrogation.

1.8 Communications in Support of SAR Operations

Overview

- 1.8.1 The SMC is responsible for utilising all available communication systems and designating specific frequencies for on-scene use during SAR operations, and for establishing reliable communications with adjacent operations centres. When appointed, the Coordinator Surface Search (CSS) or the On Scene Coordinator (OSC) is responsible for establishing reliable communications between all participating search assets and the RCC.
- 1.8.2 The SMC is responsible for informing all SAR participants of the specific frequencies selected for an operation. The SMC should designate a primary and secondary frequency in the appropriate frequency bands (HF, VHF and UHF) for use as on-scene channels.

SAR Frequencies

- 1.8.3 The following frequencies have been authorised for use in SAR operations:
- 2182, 3023, 4125, 5680 kHz. These frequencies may be used for communications between mobile stations when employed in coordinated search and rescue operations, including communications between these stations and participating land stations;
 - 123.1 MHz The international SAR on-scene frequency for use in coordinated SAR operations. Ships with this capability are authorised to communicate on this frequency with aircraft for safety purposes;
 - 123.2 MHz For supplementary continental use in on-scene coordination within the Australian SRR; and
 - 282.8 MHz Used by military ships and aircraft for communications during coordinated SAR operations.
- 1.8.4 The aeronautical mobile service uses amplitude modulation (AM) for VHF telephony while the maritime mobile service uses frequency modulation (FM). These services are incompatible.

SAR Call Signs

- 1.8.5 While it was traditional for aircraft to only use ‘RESCUE’ call signs when engaged on actual SAR operations, the growth of the Emergency Medical Service sector has seen call signs prefixed with ‘RESCUE’ being used on a day-to-day basis. The authority for the use of ‘RESCUE’ call signs rests with Airservices Australia, which has accepted this practice. The call signs being used are either in the Army aircraft block or the civil aircraft block (see below). The only organisation routinely using ‘RESCUE’ call signs for SAR tasks is the RAAF. The RAAF has sub-divided its block and allocated specific call signs to various bases.
- 1.8.6 With the exception of the RAAF, the normal practice is for aircraft engaged in SAR operations to continue to use their existing civil or military call sign. In exceptional circumstances, search aircraft may be allocated a ‘RESCUE’ call sign followed by a three-digit number that is drawn from the following bands:
- Army Aircraft - 001-100;
 - RAAF aircraft - 101-310;
 - Civil aircraft - 311-799;
 - Naval aircraft - 800-930; and
 - Foreign aircraft - 931-999.

- 1.8.7 If allocation of call signs for surface assets is required, the following may be used:
- a) Marine assets: 'SAR LAUNCH ... (number)'; and
 - b) Land assets: 'LAND RESCUE ... (number)'.
- 1.8.8 Ships of the Australian Defence Force will use their names as call signs when employed on SAR operations, i.e. 'This is HMAS Melbourne'.

1.9 Communications Facilities

Overview

- 1.9.1 There are many communication facilities available for use in SAR operations. It is important that personnel employed in SAR learn what facilities and services are available at their specific location and throughout their area of operations. Some of the more extensive and readily available facilities are:
- a) The AMSA HF DSC network operating two maritime communications stations (Wiluna and Charleville). The network Coordination Centre is collocated with JRCC Australia that allows direct communications between JRCC Australia and SAR assets on scene when working HF frequencies;
 - b) The State and Territory authorities have in place a network of nine limited coast radio stations around Australia monitoring 4, 6 and 8 MHz distress frequencies in the HF voice band (see Volume 2, Chapter 1.9.9). These authorities also operate VHF sites covering channel 16 and 67;
 - c) Each State/Territory has an extensive volunteer marine radio network. Many of these stations do not operate 24 hours but do operate in the 27 MHz, VHF and MF bands;
 - d) Discon - this is an extensive secure network linking all Defence authorities. It interfaces with the Naval Broadcast System for ships at sea and the RAAF ground-to-air communication system;
 - e) Aeronautical Fixed Telecommunications Network (AFTN) - an international teleprinter network based on ICAO requirements for air navigation services, including SAR. Details of the network can be found in the communications section of the various ICAO Regional Air Navigation Plans. The AFTN in Australia is operated by Airservices Australia;
 - f) Satellite communications offering voice, FAX and data;
 - g) Mobile phone and texting communications; and
 - h) Electronic (Email, internet, skype and video conferencing).

Communications Capabilities Australian Defence Force Ships and Aircraft

- 1.9.2 Ships and aircraft of the Australian Defence Force are fitted with communications equipment which allows for coverage of many of the emergency and SAR frequencies. Table 2-1 shows the communications capabilities of ships of the defence force by type.

Frequency Band Unit/Type	2 to 30 MHz	118 to 136 MHz	156 to 174 MHz	225 to 400 MHz
Frigates and larger ships	X		(1)	X
Small ships and submarines	X		(1)	X

Table 1-1 Communication Capability Ships of the RAN

Note: Frequency coverage in this band depends on the type of equipment fitted. However, all ships can monitor 156.8 MHz FM.

- 1.9.3 The RAN is in the process of equipping its warships with a full suite of GMDSS communications comprising Inmarsat C and VHF/HF DSC. Military assets are generally fitted with 406 MHz distress beacons.

International Distress Frequencies - Guarded by Royal Australian Naval Ships

- 1.9.4 A distress watch is maintained as follows by naval ships at sea:

Major warships (Frigates and above)	HF/VHF DSC, VHF Channel 16	Listening watch will be maintained on Channel 16 until further notice.
Minor warships (Patrol boats and mine-hunters)	VHF Channel 16	Continuous loudspeaker watch.

Table 1-1 Distress frequencies guarded by RAN

Lines of Communications - NAVY

- 1.9.5 When a SAR operation is in progress and RAN resources are allocated, JRCC Australia would normally liaise with HQJOC JCC MAROPS (MAROPS). However, in some situations, MAROPS may authorise the JRCC Australia to communicate directly (DIRLAUTH) with the RAN resource involved. HQJOC and the appropriate involved assets are to be included as information addressees on all relevant signal traffic.

Search and Rescue Visual Signals

- 1.9.6 Appendix D-1 lists some of the international visual signals that can be used for Search and Rescue purposes. The appendix also contains other visual signals that maybe used by ships or aircraft of other nations when in the Australian SRR.

Merchant Shipping and GMDSS

- 1.9.7 Communications between merchant vessels in distress and SAR organisations are achieved by a satellite and radio watch system known as the Global Maritime Distress and Safety System (GMDSS). The GMDSS enables a distress alert to be transmitted and received automatically over short and long distances. The system allows SAR authorities as well as shipping in the vicinity of the distress to be rapidly alerted so that a coordinated search and rescue operation can be commenced with the minimum of delay.
- 1.9.8 Additionally the GMDSS provides for urgency and safety communications, and the dissemination of Maritime Safety Information (MSI). Certain fishing vessels and other marine craft may also carry GMDSS equipment. RCC personnel may seek advice from JRCC Australia staff who are familiar with the SOLAS GMDSS provisions and associated IMO documents. GMDSS equipped vessels can be expected to perform the following functions wherever they operate:
- Transmit ship-to-shore distress alerts by two independent means;
 - Receive shore-to-ship alerts (usually relayed by International RCCs);
 - Transmit and receive ship-to-ship distress alerts;
 - SAR coordinating communications;
 - On-scene communications;
 - Locating signals;
 - Maritime safety information;
 - General radio communications to and from shore; and
 - Bridge to bridge communications.

Limited Coast Radio Stations

- 1.9.9 In Australia, Limited Coast Radio Stations (LCRS) are located in nine locations: Sydney, Gladstone, Cairns, Darwin, Port Hedland, Fremantle, Adelaide, Melbourne and Hobart and maintain a continuous radio watch by monitoring the following distress frequencies:
- 4125, 6215, and 8291 kHz with 8176 kHz used to broadcast weather and warnings at regular times;
 - 156.8 MHz (VHF CH16). Channel 16 is monitored in various other locations in each State/Territory;
 - Channel 67 is used to broadcast weather and warnings.
- 1.9.10 The State/Territory LCRS use the common call sign of “Coast Radio” preceded by the site. For example: Hedland Coast Radio or Hobart Coast Radio.
- 1.9.11 In addition to the State/Territory LCRS, the SAR net is extended by Limited Coast Stations operated by fishing cooperatives and volunteer SAR organisations. Each Limited station caters for a group or groups of marine craft in its local area. Depending on the capability of its equipment, a Limited station may monitor 2182/2524 kHz, VHF CH16 and 27.88 MHz for pleasure craft, and 2182/2112/4535/4620 kHz and VHF CH16 for fishing craft.

Ship Stations

- 1.9.12 There are three distinct categories of vessels to be catered for by the marine SAR system; these are:
- Deep sea vessels (SOLAS);
 - Fishing vessels; and
 - Pleasure craft.
- 1.9.13 Most deep-sea vessels will carry communications equipment compatible with the GMDSS. Other vessels, most of which use satellite communications, may extend this coverage. A continuous bridge listening watch is kept on VHF Ch16, as far as is practicable.
- 1.9.14 Vessel Tracking System (VTS) is utilised by most states/territories to monitor the location of SOLAS vessels with the reef systems and other locations posing heavy traffic or environmental concerns.

Fishing Vessels

- 1.9.15 Some fishing vessels will carry GMDSS equipment; however the majority of fishing vessels carry a variety of radio equipment and do not maintain regular watches. Frequencies allocated to fishing vessels are normally not compatible with large ships.
- 1.9.16 Some fishing vessel operators are members of cooperatives and their normal procedure whilst fishing is to maintain daily radio schedules with the cooperative base station.
- 1.9.17 AFMA and some State Fisheries Authorities use Vessel Monitoring Systems (VMS) utilising Inmarsat-C polling to track fishing vessels in their fisheries for regulatory reasons. These authorities may be able to assist an RCC in contacting or locating fishing vessels.

Pleasure Craft

- 1.9.18 These craft are under state control and hence the regulations concerning the carriage of radio and other SAR equipment vary from state to state, and within the state, depending upon the type and size of craft and its area of operations.
- 1.9.19 There is a general acceptance by the boating community of the need to carry some type of radio. The 27 MHz marine radio is a popular choice. 27.88 MHz has been designated as the primary distress, safety and calling frequency, with 27.86 MHz as the secondary.

-
- 1.9.20 These frequencies are often referred to as channels 88 and 86 respectively and care must be taken not to confuse them with the VHF Marine FM frequencies that are always referred to as channels. VHF Marine FM radio is increasingly being used by pleasure craft.

Volunteer Organisations

- 1.9.21 Clubs and other interested groups have set up base radio stations, mainly in popular sea recreational areas around Australia. Each station is normally staffed on an “as required” or “considered necessary” basis. Some offer continuous coverage, but most offer only casual coverage.
- 1.9.22 The majority of voluntary organisations equipped with HF SSB equipment are capable of responding to calls on the 2 MHz, 4 MHz and 6 MHz marine bands.
- 1.9.23 2182 kHz is normally monitored continuously as the internationally recognised primary Distress frequency on HF. However, 2524 kHz as the calling and working frequency for shore stations and pleasure craft, is still traditionally preferred and monitored by many operators since in the past informal communications on this frequency were not subject to operational controls by the ACMA.
- 1.9.24 In addition to HF, the use of VHF Maritime Mobile FM (156-174 MHz) service equipment and 27MHz Inshore Boating Radio Communication service equipment is gaining popularity with small craft owners. The recognised Distress/Emergency frequencies respectively are VHF Ch16 and 27 MHz Channel 88.
- 1.9.25 The use of the 27MHz band is uncontrolled and not guarded on an official basis.

Communication Capabilities of State & Territory SAR Authorities

- 1.9.26 State SAR authorities maintain extensive communications networks both interstate and intrastate. Arrangements for the use of these communications facilities are in accordance with Commonwealth-State SAR plans.

Command/Communications Caravans

- 1.9.27 There are a number of Police and emergency services communications caravans around Australia and these are equipped to utilise available communications facilities and may be deployed to a Forward Field Base.

Marine

- 1.9.28 Each State/Territory SAR authority maintains radio-equipped vessels with in-shore SAR capabilities. Capabilities and locations of these assets are contained in local facilities registers.

Air Wings/State and Community provided aerial assets

- 1.9.29 States and Territories have aviation assets with appropriate communications equipment.

Communications Aircraft

- 1.9.30 A dedicated communications aircraft should be used when communications are expected to be poor in the search area and:
- HF is the only means of communication;
 - It is a large scale search;
 - It is necessary to improve information feedback into the RCC;
 - It is necessary to improve information flow to SAR assets;
 - Search aircraft are operating without contact with a ground station; or
 - It is the best method of maintaining communications with survivors/ground search assets and ground rescue assets.

-
- 1.9.31 A communications aircraft will normally be a suitably equipped SAR assets aircraft or a Military aircraft, have a minimum crew of pilot and radio operator, and have good on scene endurance.

Inmarsat Aero

- 1.9.32 Subscribers to the INTERNATIONAL MARITIME SATELLITE (INMARSAT) Aeronautical System may make telephone and facsimile calls while airborne by way of this system. Similarly, terrestrial subscribers may initiate communication with airborne aircraft fitted with INMARSAT aeronautical satellite communication (SATCOM) equipment.
- 1.9.33 Not all countries have arrangements to route ground originated calls to the INMARSAT Aeronautical System.
- 1.9.34 The INMARSAT Aeronautical System offers a capability for communication of distress calls from airborne aircraft via a Land Earth Station (LES) to nominated SAR centres. The Perth LES provides ground-to-air and air-to-ground voice and data facilities for aircraft operations throughout the Indian and Pacific Oceans. It is conceivable that the Perth LES could receive distress calls originating from two thirds of the globe.
- 1.9.35 Perth LES has a standing procedure to relay all distress calls received via this system to the Australian JRCC. Voice calls are directed automatically to the designated JRCC telephone number, an alarm will be generated indicating a distress call is being processed and a hard copy print out will be produced detailing a LES-specific aircraft identification. LES staff will contact the JRCC as a matter of urgency to ensure SAR staff have received the message. If required, the LES staff can access station files to determine the aircraft registration from the LES-specific identification provided in the original message. The JRCC will then be enabled to begin checks to ascertain the status of the aircraft. The JRCC will only consider a distress situation exists after voice contact with the target aircraft has been established and the situation evaluated.
- 1.9.36 No international agreements for coordinated handling of distress calls outside Australian airspace are yet in place. However, in keeping with fundamental JRCC procedures, the JRCC when made aware of an aircraft in distress through this system shall initiate action to confirm the circumstances and location of the aircraft. Then render all possible assistance and work to establish those ground assets best placed to provide an on-going SAR service. Checks should be made through ATS units and JRCCs with responsibilities in airspace in which the distressed aircraft is thought to be operating.

1.10 Land Search Communications

Overview

- 1.10.1 Distress communications includes all messages relating to immediate assistance required by persons, vessels or vehicles in distress, including medical assistance. Distress communications may also include SAR communications and on-scene communications. Distress calls take absolute priority over all other transmissions; anyone receiving a distress call must immediately cease any transmissions that may interfere with the call and listen on the frequency used for the call.
- 1.10.2 Distress and safety communications require the highest possible integrity and protection from harmful interference. Any interference that puts at risk the operation of safety services, degrades, obstructs or interrupts any radio communications, is harmful. Some frequencies are protected, in that they have no authorised uses other than for distress and safety. SAR personnel should be particularly careful not to cause harmful interference, and should co-operate with authorities to report and stop incidents of interference.
- 1.10.3 The object of search and rescue (SAR) communications is to make possible the conduct of SAR operations. Such communications must allow for:
- a) Rapid transmission of distress messages from aircraft, persons, vessels or vehicles, including for medical assistance;

-
- b) Rapid communication of distress information to the authorities responsible for organising and effecting rescue;
 - c) Coordination of the operation of the various SAR assets; and
 - d) Liaison between controlling/coordinating authorities and SAR assets.
- 1.10.4 The communications system is the means by which control is maintained and therefore any system should be:
- a) Efficient;
 - b) Reliable; and
 - c) Self-sustaining.

1.11 Communications

- 1.11.1 Sound communications, involving not only the use of telephones and radio, but as many alternative systems as possible, must be pre-planned and implemented. Basic requirements are:
- a) Between Search Headquarters, Field Search Headquarters and Support Base;
 - b) Between Search Headquarters and Assembly Area (if set up);
 - c) Between Field Search Headquarters, Search Teams and Sub- Headquarters if necessary; and
 - d) Between Field Search Headquarters and Support Base.

1.12 Communications Officer

- 1.12.1 It is the task of the Communications Officer, if available, otherwise the command team, to ensure that as far as practicable, the SMC's actions and decisions are never restricted through lack of communications.
- 1.12.2 Although Communications Officers need not be technicians, they must understand the broad characteristics, capabilities and limitations of the various means of communications that may be employed. Good communications do not just happen—they must be planned.

1.13 Communication Requirements

- 1.13.1 The possible variations in requirements are almost unlimited but can be broadly classified as:
- a) Headquarters;
 - b) Rear net; and
 - c) Forward net.

1.14 Headquarter Requirements

- 1.14.1 The Search Headquarters may be the nearest Police Station or building which already has landline telephone facilities and/or mobile service and good access. If this is not available, consideration must be given to the following aspects in choosing the site for Search Headquarters:
- a) A house or building with telephone landline and/or mobile service, light and power already connected.
 - b) Site satisfactory for radio, which is elevated and clear of possible sources of electrical or other interference. The Communications Officer would normally choose this site provided it was compatible with the other operational factors mentioned.
 - c) Good access for both vehicles and people to provide for possible use of messengers.
 - d) Consideration of radio repeaters should be made early.

1.15 Telephone/Radio

- 1.15.1 If a telephone is available, maximum use should be made of this facility, particularly for communication of long or complicated messages, but a backup radio system may be necessary. If distances are short, field telephones are an efficient alternative. Messengers could be used if no other method was available.
- 1.15.2 Radios are always the preferred method of mass communication to all search assets.

1.16 Rear Net

- 1.16.1 This may involve communications from Search Headquarters to:
 - a) Field Search Headquarters;
 - b) Support Base;
 - c) Assembly Area (if established);
 - d) Statutory authorities;
 - e) Government instrumentalities; and
 - f) Voluntary organisations.
- 1.16.2 Communications here would most likely be by telephone. If the search appeared to be escalating into a lengthy operation, consideration could be given to the provision of direct telephone lines by liaising with the service provider. However, cost is likely to be incurred therefore expenditure approval should be obtained before installation.

1.17 Forward Net

- 1.17.1 This can be defined as the communications required from Field Search Headquarters to the searchers in the field and these requirements can vary considerably. The most likely configuration would be from Field Search Headquarters to:
 - a) Support Base
 - b) Search assets; and
 - c) Sub-headquarters if employed.
- 1.17.2 The principle here is to use whatever communication systems are available, but generally the forward net would depend on radio as the primary method, and telephones can be a secondary method. Satisfactory communications can be quickly established provided the Communications Officer is aware of the SMC's operational requirements relating to quantity, range, and the terrain over which they will be required to operate. If the operators understand the basic characteristics and limitations of the sets in use, and normal radio net discipline is maintained, reliable communications will be achieved.
- 1.17.3 A sample of the search communications net diagram is shown as Appendix E-12.
- 1.17.4 Appendix E contains the recognised radio terminology.

1.18 Frequencies

- 1.18.1 The most common methods of radio communications are listed below:
 - a) HF (High Frequency) - HF operates in the band 3 to 30 MHz. In addition to ground waves, sky wave operation is possible which vastly increases the range. This type of transmission relies on 'bouncing' radio waves from a layer of ionised gases 150 km above the earth's surface and back down to ground. Considerable distances can be achieved using HF. However, the system tends to be noisy and requires large aerial installations and some

degree of expertise to operate. It would normally be used only as a rear link back to a search headquarters;

- b) VHF (Very High Frequency) - VHF operates in the band 30–300 MHz. This type of transmission is commonly used by mobile radio fleets and gives reliable communications over a distance of 20–30 km. It is primarily ‘line of sight’ transmissions. This means that hills or major obstacles may impede reliable communications and the base site should always be as high as possible. Some difficulty may be experienced at times by searchers losing communications. If this happens, operators should be aware that a small change in location or moving to a high point may assist in regaining contact. This applies equally to UHF; and
- c) UHF (Ultra High Frequency) - UHF operates in the band 300– 3000 MHz. This method is strictly ‘line of sight’ and in flat or open terrain, to increase its range, it requires repeater stations on some high point to relay messages and therefore requires some degree of technical expertise to install.

1.19 Radios in general

- 1.19.1 UHF CB style radios provide the best balance between portability and communications. Not only searchers and headquarter bases should be provided with UHF radios but their carriage and usage by persons travelling in the more remote areas of Australia should be encouraged.
 - a. A vehicle mounted radio attached to an external antenna will provide the best coverage although a hand-held device will also work, albeit with a limited range. Spare batteries should always be carried if the radio is not hard wired.
 - b. UHF Channel 9 or 40 have been identified as “listening channels”. Once a call has been established, users can move to a clear channel.
 - c. UHF Channel 5 is a designated emergency channel, while this is Duplex it is also an emergency Simplex channel and there are no duplex repeaters on this channel in the bush.
 - d. UHF Channel 11 is a dedicated Australian calling frequency which after establishing contact users move to another channel.
 - e. While the above channels are dedicated, a search asset with a scanning radio will detect a missing person calling on any channel within range. Modern scanning radios cover all 40-80 channels every 4 seconds, ensuring that not active channel is missed.
- 1.19.2 Attention must be given to the state of the batteries in portable sets and spare batteries should always be available. Batteries should not be left in sets which will not be used for any length of time. It is recognised that most radio failures are caused by a lack of care and knowledge on the part of operators, rather than deficiencies within the sets themselves.
- 1.19.3 Loss of communications: During search operations it is likely that situations will arise where radio communications are less than 100% effective. Teams should be briefed as to their actions in case of a loss of communications. These actions may include backtracking to their last point of communication, problem solving, using other forms of communication, relaying through other stations, non-use of Distress Devices – ‘no news is good news’, or carrying on with an assigned task – ‘be at this spot at this time’.
- 1.19.4 Ground to Air Communications: Aircraft operate on aviation transport group frequencies allocated by Australian Communications Authority and can be contacted through the airport control tower, but radios are available which can contact aircraft on a special frequency. Prior arrangement with the aircraft pilot is necessary to work on this channel as the aircraft normally listens out on tower frequencies.
- 1.19.5 Another alternative is to place on board the aircraft a portable radio on the same frequency as is being used by the search teams.

1.20 Procedures and Practices

- 1.20.1 To achieve efficiency, standard radio procedure should be used. Although two-way conversations will be needed, messages should be written for reference at a future time. It may also be necessary to refer to past actions or decisions and this makes necessary the keeping of a written record. Search Team Leaders should carry a note book to record messages.

1.21 Other Methods of Communications

- 1.21.1 Mobile telephones: The rapid expansion of the mobile telephone network throughout Australia has provided the SAR coordinator with another option for SAR communications, although it must be noted that they do not work in all locations. A number of considerations must be taken into account by the SMC when considering mobile telephones as a communications method:
- a) The use of a radio net should always be the first option,
 - b) The extent of the networks and coverage at the search location
 - c) The availability and type of mobile telephones at the search location
 - d) The battery life and ability to recharge those mobile telephones available
 - e) The ability to send and receive spoken words, text messages and photographs.
 - f) Mobile telephones may be considered as a secondary communication method, and when direct and private contact is to be made between the SMC and teams.
 - g) The use of text messages may be more successful than verbal communications. Text messages require less signal strength and will be received when a mobile telephone comes within range even if it is some time since it was originally sent.
- 1.21.2 Other methods of communicating, which can be used but require some degree of prior planning are:
- a) Control of Contact or Close Search - Whistles, loud hailer, and simple voice orders. (To contact both single and multiple teams).
 - b) Location of Search Teams or Finds - Smoke, light (fire), signalling mirrors.
 - c) Recall signals - Whistles, sirens, gun shots, pyrotechnic rockets.
 - d) The General Public - Commercial radio stations for supplying information and instructions to the public.
 - e) Mobile Communications - For relay points.
 - f) Field Signals - Searchers may be required to use field hand signals or audible sounds to communicate within or between teams. Recognised audible signals are:
 - i) One short blast at irregular intervals - searchers looking for a missing person and as an acknowledgment of a distress signal;
 - ii) Three short blasts together, regularly spaced—distress signal; and
 - iii) Four short blasts together, regularly spaced—which is recall signal.
- 1.21.3 Short blasts are regarded as sounds audible for one second. Where organisations use audible signals for other purposes, three blasts must be avoided.
- 1.21.4 Summary: The success of a land search will largely depend on good planning and adequate control in the field. This is based on the SMC having a free hand to deal with field operations, at the same time receiving maximum support from the Search Commander.
- 1.21.5 Under no circumstances should unofficial searchers be allowed in the search area, and any person disobeying instructions should be withdrawn immediately.

Chapter 2 Awareness and Initial Action

2.1 Awareness Introduction

- 2.1.1 When the SAR system first becomes aware of an actual or potential emergency, the information collected and the initial action taken are often critical to a successful SAR operation. It must be assumed that in each incident there are survivors who will need assistance and whose chances of survival are reduced by the passage of time. The success of a SAR operation depends on the speed with which the operation is planned and carried out. Information must be gathered and evaluated to determine the nature of the distress, the appropriate emergency phase, and what action should be taken. Prompt receipt of all available information by the RCC is necessary for thorough evaluation, immediate decision on the best course of action and a timely activation of SAR assets to make it possible to achieve the following:
- a) Locate, support and rescue persons in distress in the shortest possible time.
 - b) Use any contribution survivors may still be able to make towards their own rescue while they are still capable of doing so.
- 2.1.2 Experience has shown that the chances for survival of injured persons decrease by as much as 80% during the first 24 hours, and those for uninjured persons diminish rapidly after the first three days. Following an accident, even uninjured persons who are apparently able-bodied and capable of rational thought are often unable to accomplish simple tasks and are known to have hindered, delayed or even prevented their own rescue.
- 2.1.3 General Considerations for the SMC: SMC duties can be demanding. The gathering of information, evaluation of this information and initiation of action all require concentrated effort on many details. The SMC will find the various forms, checklists, worksheets, tables and graphs provided in the appendices to be very helpful. The following paragraphs provide some general guidance for the early stages of a SAR operation, including information gathering and preparation for the possible need to plan searches.
- 2.1.4 Several factors will influence the extent and manner of an initial SAR response. In general these are the:
- a) Extent and reliability of information about the location of the missing persons
 - b) Availability of aircraft, maritime assets and land parties for searching;
 - c) Prior, actual and forecast weather conditions;
 - d) Times of daylight/darkness;
 - e) Nature of terrain/sea conditions;
 - f) Availability of survival supplies and supply dropping teams; and
 - g) Time delay in notification.

2.2 Types of SAR Incidents

- 2.2.1 There are many different types of incidents reported to the SAR system that must be evaluated and resolved. Most of these incidents may be grouped by the type of target involved, the environment, and in the case of individuals, by the type of difficulty being encountered.
- 2.2.2 In general a SAR incident is considered imminent or actual when it is apparent that persons are, or may be, in distress or when a request for assistance has been received.

Maritime SAR Incident

- 2.2.3 A maritime SAR incident is considered imminent or actual when any of the following conditions exist:
- a) A surface vessel or other marine craft has requested assistance.
 - b) A surface vessel or other marine craft has transmitted or displayed a distress signal.
 - c) It is apparent that a surface vessel or other marine craft is in distress.
 - d) A surface vessel or other marine craft is reported to be sinking or to have sunk.
 - e) The crew is reported to have abandoned ship or is about to do so.
 - f) Reports indicate that the operating efficiency of the marine craft is so impaired that the craft may sink or the crew may be forced to abandon.
 - g) The surface vessel or marine craft is overdue or unreported (and initial evaluation has failed to resolve the incident).
 - h) Persons are in the water and require assistance.
 - i) A distress beacon has been activated.
 - j) A MEDEVAC is required on medical advice.

Aviation SAR Incident

- 2.2.4 SAR alerting action is based upon the type of notification and flight procedures adopted by an aircraft, for example:
- a) Aircraft that comply with full reporting procedures where a continuous communications SAR watch is maintained fails to report at the next scheduled time.
 - b) Aircraft that have nominated a SARTIME where alerting action commences at the time of expiration of the SARTIME.
 - c) Aircraft that have not submitted flight notification where alerting action is commenced on the receipt of incidental information from any source which leads to doubt as to the aircraft's safety. This includes notification from a person or organisation holding a Flight Note.
- 2.2.5 An aircraft SAR incident is considered imminent or actual when:
- a) A SARTIME for an aircraft has not been cancelled.
 - b) An aircraft fails to report arrival or if it has failed to report position,
 - c) ATS declare a SAR phase (INCERFA, ALERFA or DETRESFA),
 - d) Information is received that an aircraft on which no flight notification has been lodged is missing, including notification from a person or organisation holding a Flight Note.
 - e) An aircraft, which has been given approach or landing instructions, fails to land. Fuel on board is considered to be exhausted or to be insufficient to enable an aircraft to reach safety.
 - f) Information is received which indicates that an aircraft is about to make or has made a forced landing, or has ditched or crashed.
 - g) Information is received which indicates that the operating efficiency of an aircraft has been impaired to the extent that a forced landing is likely.
 - h) A distress beacon is reported to be transmitting. (Aircraft required to carry a distress beacon normally have an ELT and/or PLB but may also carry EPIRBs, for example in life rafts).

Land SAR Incident

- 2.2.6 A land SAR incident is considered imminent or actual when:
- a) A request for assistance is received;
 - b) A vehicle or person is reported overdue;
 - c) It is apparent that a vehicle or person is in distress;
 - d) A distress beacon has been activated; and/or
 - e) A MEDEVAC is required.

2.3 Recording of Events

- 2.3.1 The RCC shall maintain records for each incident in which all information should be recorded as it is received, either in full or by reference to other permanent records such as flight plans, forms, charts, maps, hard copy messages, recorded RADAR data etc. Details of all phases notified to the RCC and all information relating to action initiated by the RCC shall be recorded in chronological order.
- 2.3.2 Where information is contained in other records, (messages, forms etc.), these shall be held in such a way that reference to them may be easily made throughout the operation. All hard copy information shall be retained for filing.
- 2.3.3 Each day's search activity shall be plotted. The total search area shall be subdivided into sections assigned to each SAR asset showing individual search patterns, aircraft heights and speeds, and other relevant details. A plot shall be kept of areas searched as well as those not searched. Areas assigned but not searched need to be readily identified for reassignment, leaving no 'holes' within the search area.
- 2.3.4 Records may be kept of the actual hours of operation of search craft, showing individual transit times and times engaged in search and/or rescue activity. These records will contribute to determining the POD of searches and may also be used for assessment of financial claims received from operators.
- 2.3.5 Records shall be kept of names of all searchers (volunteers and professional) used in SAR operations on assets tasked by the RCC usually in the form of a manifest or 'T' cards (i.e. Aircraft and aerial observers, vessels and crew, search teams).
- 2.3.6 When a search has been terminated without locating a missing target (aircraft or its occupants vessel or its occupants or missing person), all records, charts, maps, etc. shall be retained and be accessible to SAR staff to allow easy resumption of search activity should further intelligence be received.
- 2.3.7 Records relating to search and rescue operations, including aviation, land and maritime searches, conducted by other organisations shall be retained.
- 2.3.8 Records should be retained for coroner's court/civil proceedings and for the possible access of other authorities.

2.4 SAR Stages

- 2.4.1 The response to a SAR incident usually proceeds through a sequence of five stages. These stages are groups of activities typically performed by the SAR system in responding to a SAR incident from the time the system becomes aware of the incident until its response to the incident is concluded. The response to a particular SAR incident may not require the performance of every stage. For some incidents, the activities of one stage may overlap the activities of another stage such that the portions of two or more stages are being performed simultaneously.
- 2.4.2 Land SAR in Australia now adopts the same five SAR staged approach as Marine and Aviation SAR shown below.

2.4.3 The five SAR stages are:

- a) **Awareness.** When the SAR system becomes aware that an emergency situation exists or may exist.
- b) **Initial Action.** Preliminary action taken to alert SAR assets and obtain more information. The stage may include evaluation and classification of the information, alerting of SAR assets, communication checks and, in urgent situations, immediate performance of appropriate activities from other stages.
- c) **Planning.** The development of operational plans including plans for search, rescue and final delivery of survivors to medical facilities or other places of safety as appropriate.
- d) **Operations.** Dispatching SAR assets to the scene, conducting searches, rescuing survivors, assisting distressed targets, providing necessary emergency care for survivors and delivering casualties to medical facilities.
- e) **Conclusion.** Return of SRAs to a location where they are debriefed, refueled, replenished and prepared for other missions, return of SAR assets to their normal activities and completion of all required documentation.

2.5 Awareness and Initial Action Stages (Stage 1 and 2)

- 2.5.1 When a SAR authority becomes aware of a possible SAR incident the SAR system is activated. The information is assessed and coordination is assumed or passed to the appropriate SAR authority for coordination.
- 2.5.2 Members of the public are encouraged to report any abnormal occurrence they have witnessed or heard about. Notification of an event may reach an RCC from any source including a member of the public, an ATS Unit or through a designated alerting post such as a police station.
- 2.5.3 For almost all emergency situations, action can be started as soon as the nature and general position of the emergency is known. Additional information, which might be helpful to the resolution of the incident, should be obtained after the initial action has been taken. Communications should be maintained with a target or person reporting an emergency situation and they should be kept advised of the action being taken.

Types of Notification Reports

Distress Alerts

- 2.5.4 Distress alerts may be received by the RCC from various sources. The following are typical examples:
 - a) Aural reception of a distress beacon by an aircraft.
 - b) Detection by the COSPAS-SARSAT satellite system.
 - c) Receipt through Airservices Australia.
 - d) Receipt through a recognized mobile satellite service provider.
 - e) Receipt through a coast radio station.
 - f) Receipt through other alerting systems, e.g. ARGOS, other SEND devices.
 - g) Direct communications from the public or the distressed target.
 - h) Another RCC or SAR authority.

Notification by Airservices Australia

- 2.5.5 For aircraft communicating with Airservices Australia, the ATS unit responsible will declare the appropriate phase and transfer the phase to JRCC Australia in accordance with the agreed Memorandum of Understanding (MOU).
- 2.5.6 JRCC Australia receives notification of aircraft emergencies through ATS units in most instances as they are in receipt of information on most flights within their areas of responsibility and are

periodically in contact with the aircraft. Each ATS unit has a responsibility to provide an alerting service to all flights known to it.

- 2.5.7 Air traffic controllers are responsible for providing in-flight-emergency response (IFER) to distressed aircraft with which they are in contact. Alerting procedures for emergency facilities requested by a pilot are an Airservices Australia responsibility.
- 2.5.8 JRCC Australia will be alerted to problems affecting a flight that could seriously jeopardise its safety while en-route through Airservices Australia.

Evaluation of Notification Reports

- 2.5.9 All reports relating to a SAR operation must be carefully evaluated to determine their validity, the urgency for action and the extent of the response.
- 2.5.10 While evaluation of reports might be difficult and time-consuming, decisions must be made and action taken as quickly as possible. If confirmation of uncertain information cannot be obtained without undue delay, the SMC should act on a doubtful message rather than wait for verification.
- 2.5.11 The evaluation of reports on overdue or missing persons, vessels or aircraft should take account of:
 - a) Communication delays: In some areas of the SRR, communication delays may prevent timely reporting. This should be kept in mind when evaluating the significance of a report in order to prevent unnecessary activation of the SAR system while ensuring that the SAR response is appropriate should the circumstance be real.
 - b) Weather conditions: Adverse weather may contribute to communication delays or deviations from flight plan.
 - c) Habits of the individual: Some individuals, including pilots, masters and hikers are known to react or may have been briefed to react in a certain manner in certain circumstances. Knowledge of these habits/company procedures may provide guidance in the evaluation of an incident and the subsequent planning and execution of search operations.

Information: SAR Incident Information

- 2.5.12 Success or failure of any operation will depend on the availability of information. This information needs to be:
 - a) Accurate;
 - b) Current; and
 - c) Relevant.
- 2.5.13 In many search operations, the time factor is critical, so there is a need to commence the search as soon as the situation allows.
- 2.5.14 All search operations present special problems in that there will be an essential conflict between the urgency imposed by the situation, and the initial delay caused by the need to gather and evaluate as much information as possible.
- 2.5.15 An understanding of the information gathering process must be a primary qualification for the Search Commander and SMC.
- 2.5.16 Information gathering aspects: There are three main aspects of information-gathering:
 - a) Type of information required;
 - b) Availability of and access to information; and
 - c) Evaluation of information acquired.

2.5.17 The Information Stages: The information process is divided into four stages:

- a) Collection - Information related to the search should be collected in the shortest possible time and often comes from unlikely sources. (Consider beacon registration, NOK, flight plans, manifests, intentions, BOM, etc.). Information required may relate to the:
 - i) Missing person(s), vessel or aircraft;
 - ii) Missing object(s);
 - iii) Environment;
 - iv) Sea conditions; Terrain/topography; and
 - v) Weather.
 - vi) Survival times
- b) Collation - Once the information has been obtained, it needs to be sorted into categories which relate to the problem. Where possible, this information should be displayed so it is readily available to the search command/control elements. In this way, the task of evaluating the information is made easier and will make decision-making simpler.
- c) Evaluation - Within this mass of information, there will be sections that are irrelevant, unreliable or dated. It becomes necessary to evaluate all information and discard all that is inappropriate, and make decisions accordingly. To change information into intelligence it must be value added, verified and/or confirmed with other sources.
- d) Dissemination - The SMC will utilise the intelligence as the basis of briefings to pass on specific and relevant information to searchers in the field, to relay information to relevant authorities, and to pass information to the family of the person and to the media. This information needs to be current, accurate and relevant so that confidence is maintained.

2.5.18 The following information, or as much of it as is required to address an emergency situation, should be obtained from the target or the individual reporting the actual or potential emergency situation or incident. As many of the items should be obtained as circumstances permit.

Aviation, Maritime or Land Incident Information

- a) Name, address, and telephone number or contact point of person reporting.
- b) Distressed target (name/type/callsign/registration) or identification.
- c) Position of emergency (latitude/longitude or bearing/distance) from a known point or the last reported position and the next reporting position).
- d) Nature of emergency (fire, collision, person overboard, disabled, overdue, crash or missing hiker etc.).
- e) Date/time of emergency occurrence.
- f) Date/time of notification.
- g) For aircraft, altitude, attitude, heading, speed and endurance.
- h) Target description (size, type, markings, hull, colour of cabin, deck, rigging, fuselage colour, tail colour, wingtip colour, unusual features).
- i) Details of persons on board, persons involved (POB) including number of people involved, ages, state of health, injuries, and intentions.
- j) Date, time and departure point, planned route, speed, ETA and destination.
- k) Radio frequencies currently in use monitored or scheduled.
- l) Emergency radio equipment and frequencies, EPIRB, ELT, or flares.
- m) Actual weather/sea conditions.

-
- n) Local action being taken or assistance required.
 - o) Owner/agent of distressed target and contact method.
 - p) Possible route deviations.
 - q) Navigation capabilities.
 - r) Survival equipment including quantity of food/water and signaling devices. Other information sources, e.g. friends, relatives, associates, yacht clubs, and aero clubs.
 - s) Mobile phone numbers of any person.

Person Overboard Incident Information

- a) Name and call sign of ship with person overboard.
- b) Position, course and speed of the ship.
- c) Date, time and position when the person went overboard.
- d) If time of person overboard unknown, when last seen.
- e) Weather conditions (include water temperature.
- f) Person's name, age and gender.
- g) Person's height and weight to determine survivability.
- h) Person's physical/mental condition and swimming ability.
- i) Person's clothing (amount and colour).
- j) Height of fall from ship to water.
- k) Lifejacket (worn, missing).
- l) Has the ship been completely searched?
- m) Will the ship search for the person overboard and, if so, for how long.
- n) Radio frequencies in use monitored or scheduled.
- o) Whether an urgency broadcast is requested.
- p) Assistance desired.
- q) Assistance being received.
- r) Initial reporter (parent agency, radio station, and name/call sign of ship).
- s) Other pertinent information.

Missing person

- a) Personal details (Name, DOB, address, telephone numbers, employment, social status, married);
- b) Physical features (Description, fitness, ability, past history);
- c) State of health (physical and mental);
- d) Medication (taken, carried or left behind) (what are the effects of this?);
- e) Psychological issues (Happiness, depression, family trouble, financial trouble, legal trouble)
- f) Dress (Wearing now and what taken? Is it suitable for the conditions?);
- g) Food/water (Any? Sufficient? Will last how long?);
- h) Handedness, (Left or right);
- i) Any means of transport (Where is it? Public transport?);
- j) Time last seen (Intentions, intended routes, previous routes?); and
- k) Any other information considered relevant.

-
- 2.5.19 Such information may well dictate the urgency of the search. If, for example, the person has a history of going missing, it may suggest a policy of wait and see. Sample forms which may assist in obtaining relevant information are included as Appendices E-1, E-2, E-3 of this Manual.

Objects/evidence

- 2.5.20 When conducting a search for an object such as aircraft, vessel, vehicle, or any other article (Police evidence search, it will be necessary to gain a complete description of the object. This should include:
- a) Description;
 - b) Make;
 - c) Model;
 - d) Colour;
 - e) Size;
 - f) Weight;
 - g) Registration number (if available);
 - h) Markings; and
 - i) Safety aspects/danger.
- 2.5.21 Where an object is unlikely to be readily identifiable, the requirement for detail is increased. If possible, a model, photograph, or drawing should be obtained. Particular emphasis should be on safety factors if the object is likely to offer a hazard to the finder. An example would be the hazards associated with modern aircraft. A sample Object Questionnaire is included as Appendix E-3 to this Manual.
- 2.5.22 After evaluating all available information in every case, the RCC should declare the appropriate emergency phase (if not already declared), or review phase as appropriate.

Advising States of Foreign Persons in Distress

- 2.5.23 If a foreign registered aircraft is subject to a Distress Phase, that is found not to be a false alarm or is involved in an accident or a foreign national is killed or injured in a SAR related incident, the relevant foreign State is to be notified through the Department of Foreign Affairs and Trade (DFAT). SMC advice should be directed to the DFAT Communications Duty Officer or the Desk Officer for the State concerned.

2.6 Emergency Phases

- 2.6.1 Emergency phases are based on the level of concern for the safety of persons, vessels or aircraft. Upon initial notification the notified SAR authority or ATS unit classifies the SAR incident as being in one of the three following emergency phases:
- a) Uncertainty Phase (INCERFA).
 - b) Alert Phase (ALERFA).
 - c) Distress Phase (DETRESFA).
- 2.6.2 The emergency phase may be reclassified by the SMC as the situation develops. The current emergency phase should be used in all communications about the SAR incident as a means of informing all interested parties of the current level of concern for the safety of persons or target which may be in need of assistance.
- 2.6.3 Maritime search and rescue in Australia is based on the GMDSS and although there are three forms of messages from a ship to the SAR authority, there is no mention of emergency phases in GMDSS documentation or IAMSAR Volume 3, the SAR manual carried by ships. However

emergency phases are referred to in IAMSAR Volume 1 and 2 and SAR officers do escalate incidents as information is received that indicates a heightened level of concern for the safety of a vessel or aircraft. Therefore emergency phases should be used internally among maritime SAR authorities to indicate the level of concern and as criteria for escalating a SAR action. An uncertainty phase relates to a safety broadcast, the alert phase to an urgency broadcast and a distress phase to the distress broadcast.

Uncertainty Phase

- 2.6.4 The uncertainty phase is assigned any time doubt/uncertainty exists as to the safety of an aircraft, vessel or person because of knowledge of possible difficulties, or because of lack of information concerning progress or position. **The keyword is DOUBT.** This does not mean that the SMC has doubt that a SAR situation exists, more that there is doubt about the level of safety of those involved.
- 2.6.5 An Uncertainty Phase is said to exist when there is knowledge of a situation that may need to be monitored, or to have more information gathered, but that does not require dispatching of resources. When there is doubt about the safety of persons, vessel or aircraft, the situation should be investigated and information gathered. For aircraft, an INCERFA is declared when:
- a) No communication has been received from an aircraft within a period of fifteen (15) minutes after the time a communication should have been received, or from the time an unsuccessful attempt to establish communication with such aircraft was first made, whichever is the earlier.
 - b) An aircraft fails to report departure from a Mandatory Broadcast Zone (MBZ) or non-standard Common Traffic Advisory Frequency (CTAF) area after a call notifying readiness to taxi or take-off or after an airborne call from within a MBZ or CTAF area, within five (5) minutes after estimate for the boundary.
 - c) An aircraft fails to arrive within 15 minutes of the last estimated time of arrival last notified to or estimated by ATS units; whichever is the later, except when no doubt exists as to the safety of the aircraft and its occupants.
- 2.6.6 For persons, vessels or aircraft, an Uncertainty Phase is declared where the persons, vessels or aircraft have:
- a) Been reported overdue at the intended destination;
 - b) Failed to make an expected position safety report; or
 - c) There has been no immediate request for assistance received but the possibility exists that a situation could escalate.

Alert Phase

- 2.6.7 The alert phase is assigned any time apprehension exists for the safety of persons, vessels or aircraft because of definite information that serious difficulty exists which does not amount to a distress or because of a continued lack of information concerning progress or position. The key word is APPREHENSION.
- 2.6.8 An Alert Phase exists when persons, vessels or aircraft are having some difficulty and may need assistance, but are not in immediate danger.
- 2.6.9 Apprehension is usually associated with the Alert Phase, but there is no known threat requiring immediate action. SRUs may be dispatched or other SAR assets diverted to provide assistance if it is believed that conditions might worsen or that SAR assets might not be available or able to provide assistance if conditions did worsen at a later time.

-
- 2.6.10 For a SAR involving an overdue target, the Alert Phase is declared when apprehension exists as to the safety of an aircraft/vessel or persons. Apprehension exists due to the lack of progress or positions of persons, vehicles or aircraft or inability to confirm safety in a suitable timeframe. At the Alert Phase, coordinators should begin or continue communications searches, land searches and in some cases tasking of vessels/aircraft to high probability locations. Vessels in the area may be asked to maintain a sharp lookout, report all sightings and render assistance if needed.
- 2.6.11 An Alert Phase is declared when:
- a) Following the Uncertainty Phase, subsequent attempts to establish communication with persons, vessels or aircraft have failed or inquiries to other relevant sources have failed to reveal any news.
 - b) An aircraft has been cleared to land and fails to land within five (5) minutes of the estimated time of landing and communication has not been re-established with the aircraft.
 - c) Information has been received which indicates that the operating efficiency of the aircraft, ship or other craft has been impaired but not to the extent that a forced landing or distress situation is likely, except when evidence exists that would allay apprehension as to the safety of that find and its occupants.
 - d) An aircraft is known or believed to be the target of unlawful interference.

Distress Phase

- 2.6.12 The distress phase is assigned whenever immediate assistance is required by persons, vessels or aircraft threatened by grave or imminent danger or because of continued lack of information concerning progress or position. **The key words are GRAVE or IMMINENT DANGER and IMMEDIATE ASSISTANCE.**
- 2.6.13 The Distress Phase exists when there is reasonable certainty that the targets are in imminent danger and require immediate assistance. For SAR incidents involving an overdue target, a distress exists when communications searches and other forms of investigation have not succeeded in locating the target or revising its ETA so that it is no longer considered overdue. If there is sufficient concern for the safety of a target and the persons aboard to justify search operations, the incident should be classified as being in the Distress Phase. For aircraft, a Distress Phase is declared when:
- a) Following the Alert Phase, the further unsuccessful attempts to establish communication with the aircraft and more widespread unsuccessful inquiries point to the probability that the aircraft is in distress.
 - b) The fuel on board is considered to be exhausted, or to be insufficient to enable the aircraft to reach safety.
 - c) Information is received which indicates that the operating efficiency of the aircraft has been impaired to the extent that a forced landing is likely.
 - d) Information is received or it is reasonably certain that the aircraft is about to make or has made a forced landing, except when there is reasonable certainty that the aircraft and its occupants do not require immediate assistance.
 - e) A report is received that a radio distress beacon has been activated or other visual distress signals have been observed.
- 2.6.14 For ships, other craft or people, a Distress Phase is declared when:
- a) Positive information is received that a ship or other craft or people are in danger and need immediate assistance; or
 - b) Information is received which indicates that the operating efficiency of the ship or other craft has been impaired to the extent that a distress situation is likely.

2.7 Initial Action: Procedures of the Emergency Phases

Overview

- 2.7.1 Since no two SAR operations follow the same pattern, it is not possible to develop comprehensive procedures to apply to all situations. The actions described in the following paragraphs should be interpreted with flexibility as many of the activities described may be performed simultaneously or in a different order to suit specific circumstances.

Uncertainty Phase Initial Action

- 2.7.2 When a SAR authority has declared an uncertainty phase, the RCC should take the following action:
- a) Designate an appropriately qualified officer as SMC for that action.
 - b) Verify the information received, considering the need to extend inquiries to:
 - i) JRCC Australia, ATS units, Police, or the Master of a vessel.
 - ii) Landing areas including the aerodrome of departure and other locations close to the route where a target aircraft might have landed (inquiries maybe made of groundsmen, refuellers, police and aerodrome operators etc.).
 - iii) Aircraft, including the target aircraft, known to be on the same route, in the same area or within communication range, by way of ATS units, or radio contacts calling or listening out, including monitoring emergency frequencies.
 - iv) Vessels known to be on the same route, in the same area or within communication range, by way of VMS, VTS, Coastal radio stations or vessel broadcasts.
 - v) Persons known to be on the same route, in the same area or within communication range, by way of electronic/social media (television, radio, Facebook, mass texting, etc.) and/or speaking to persons located within the search area.
 - vi) Family, friends, operator of the aircraft, marinas, etc.
 - c) When no flight plan has been filed, or in the case of ships or other craft, no information is available on the intentions of the captain, attempt to obtain information from which the route and departure, flight and arrival times of the aircraft, ship or other craft may be determined.
 - d) Establish close liaison with alerting assets to ensure that the following occurs:
 - i) New information, (e.g.: obtained through widespread communication checks, requests to the public, review of weather factors, etc.), will be made immediately available to the RCC for evaluation, plotting, decision making etc.
 - ii) Duplication of action will be avoided.
 - e) Plot the route of the target, making use of all available intelligence.
 - f) Conduct a communications search.
 - g) Determine actual weather conditions along the route and at the destination.
 - h) Record all incoming information and progress reports, details of action as described below, subsequent developments and decisions.

Communication Search

- 2.7.3 The communication search can be conducted by the following two primary methods:
- a) Attempting to communicate with the person, vessel or aircraft by all means of electronic communications through various paths.

-
- b) Determining the target's most probable location by:
 - i) Making inquiries at aerodromes (including the aerodrome of departure) and other locations where an aircraft might have landed or at locations where a ship or other craft might have stopped or called (including the point or port of departure).
 - ii) Contacting other appropriate sources including persons who may have knowledge of the intentions of the pilot in command or ship's captain.
 - iii) Using electronic methods to track mobile telephones, leave text or voice mail messages or utilise electronic/social media (television for witnesses, radio, Facebook or similar).

Phase Transition

- 2.7.4 When the communications search or other information received indicates that the person, vessel or aircraft is not in distress, the SAR authority will close the incident and immediately inform the operating agency, the reporting source and any alerted authorities, centres, or services. However, if apprehension regarding the safety of the person, vessel or aircraft and its occupants continues, the Uncertainty Phase should progress to the Alert Phase.

Alert Phase Procedures

- 2.7.5 When an Alert Phase has been declared by the RCC or transferred from Airservices, another RCC or SAR authority, the RCC should:
 - a) Initiate or continue any appropriate actions normally performed during the Uncertainty Phase and in particular, ensure a SMC has been appointed and that all interested parties have been informed of the incident.
 - b) Record all incoming information and progress reports, details of action as described below, subsequent developments and decisions.
 - c) Verify the information received.
 - d) Obtain information about the aircraft, vessel or person from other sources not previously contacted, such as:
 - i) Communications stations associated with radio navigation aids, RADAR facilities, direction-finding stations any may other communication stations that might have received transmissions from the target.
 - ii) All possible landing or stopping points along the intended route and other agencies and assets included in the flight or voyage plan that may be capable of providing additional information or verifying information.
 - e) Maintain close liaison with relevant ATS units and, as appropriate, request that they:
 - i) Pass information to aircraft involved in the emergency;
 - ii) Inform aircraft operating in the vicinity of the target aircraft of the nature of the emergency; and
 - iii) Monitor and keep the RCC informed of progress of any aircraft whose operating efficiency is impaired.
 - f) Plot relevant details obtained through the actions described above on an appropriate map or chart to determine the probable position of the target and its maximum range of action from its last known position and plot the positions of any target known to be operating in the vicinity.
 - g) Consider initiating en-route diversions of other craft to attempt to locate or confirm the safety of the target subject to the agreement of the pilot in command/operator or master and there being no hazard due to weather or other factors including:
 - i) The diverted craft's operator shall be advised whenever a diversion is undertaken, and

-
- ii) The capabilities of the aircraft considered for diversion including its navigation integrity and range, terrain, weather conditions and any other salient operational factors.
 - h) Thoroughly evaluate the plan, weather, terrain, possible communication aberrations, last known position, last radio communication and operator's qualifications and experience.
 - i) Estimate time of fuel exhaustion and research the target's performance under possibly adverse conditions.
 - j) Determine and plot the most probable position of the target and, if relevant, its maximum range of operation from its last known position.
 - k) Alert SAR assets to the possible need for search and rescue action, obtaining relevant details of asset availability; if necessary placing assets on a higher level of readiness.
 - l) Notify other SAR authorities, shipping authorities, etc. as soon as possible where they are likely to be called upon to conduct search activity.
 - m) Consider the need for military assistance where the situation is judged likely to be beyond the capacity of available civil resources.
 - n) Ensure that the procedures for notification of next of kin of the occupants are implemented.

Phase Transition

- 2.7.6 When information received indicates that the person, vessel or aircraft is not in distress, the RCC will close the incident and immediately inform the operating agency, the reporting source and any alerted authorities, centres or services.
- 2.7.7 If the person, vessel or aircraft has not been located when all efforts have been completed; if apprehension regarding the safety of the aircraft and its occupants continues, or if the time of an aircraft's fuel exhaustion has been reached, whichever occurs first, the target and its occupants should be considered to be in grave and imminent danger. The Alert Phase should then progress to the Distress Phase. The decision to declare the Distress Phase should be taken without undue delay and on the basis of past experience with similar situations.

Distress Phase Procedures

- 2.7.8 When a distress phase has been declared by a SAR authority or transferred by Airservices, another RCC or SAR authority, the SAR authority should:
 - a) Initiate or continue any appropriate actions normally performed during the Uncertainty and Alert Phases.
 - b) Ensure an SMC has been appointed and that all interested parties have been informed of the incident.
 - c) Examine the detailed plans of operation for the conduct of SAR operations in the area.
 - d) Determine the availability of SAR assets to conduct SAR operations and attempt to obtain more assets if a need for them is anticipated.
 - e) Estimate the position of the target, estimate the degree of uncertainty of this position and determine the extent of the area to be searched and if a significant search effort is anticipated, use search planning techniques to maximise the chances of finding the survivors.
 - f) Develop a search action plan or rescue plan as appropriate for the conduct of the SAR operation and communicate the plan to the appropriate authorities.
 - g) Initiate action, activating SAR assets as appropriate such as:
 - i) Search assets may be dispatched from their bases in accordance with the search plan.
 - ii) Aircraft and vessels may be diverted in-flight or en-route.

-
- iii) Whenever practicable, aircraft dispatched early should carry droppable supplies (suitable for the environment in which the incident is occurring) unless these aircraft are unsuitable for dropping and/or an unacceptable delay would result to their departure on account of loading.
 - iv) In the latter case, droppable supplies should be loaded on a suitable aircraft as soon as possible. Aircraft carrying droppable supplies must be configured in conformance with JRCC Australia documentation.
 - h) Amend the plan as the operation develops.
 - i) Notify the State of registry of the target, if applicable.
 - j) Notify JRCC Australia, ADF, State or Territory Police, Maritime Authorities, ATSB and/or CASA, Media as appropriate.
 - k) At an early stage, request aircraft, vessels, coastal radio stations and other relevant services to:
 - i) Maintain a listening watch for transmissions from the target, by voice, survival radio equipment and from an emergency beacon (ELT/EPIRB/PLB);
 - ii) Assist the target as far as practicable if found; and
 - iii) Inform the RCC of any developments.
 - l) Maintain close liaison with the following:
 - i) Appropriate agencies for onward transmission to the target (if possible) and for traffic coordination.
 - ii) Other RCCs along the planned route of the target as well as those whose SRRs are within the target's maximum radius of action as determined from its last known position (i.e. the possibility area), ensuring that any information they receive regarding the incident is conveyed to the coordinating RCC.
 - m) Inform community groups by way of radio and television broadcasts requesting sighting and hearing reports and any other intelligence regarding the whereabouts of the target using established procedures for contacting designated personnel at broadcasting stations and specifying messages in precise form.

Phase Transition

- 2.7.9 When the distressed person, vessel or aircraft has been located and the survivors rescued, the RCC will terminate the SAR operation, close the case and immediately advise the operating agency, the reporting source and any alerted authorities, centres and services. To ensure that search assets remain under some type of flight or vessel following system, the SMC should not terminate activities until all SAR assets have established alternative following plans, where they apply.

2.8 Intelligence Gathering and Assessment

Overview

- 2.8.1 Information relating to a missing target may be gathered from a variety of sources, in particular from the owner or operator, Airservices and general maintenance records and from the public at large.
- 2.8.2 Where possible, a SAR rated officer shall be appointed as the RCC Intelligence Officer and given the task of seeking information and assessing and verifying information received.
- 2.8.3 Careful and accurate assessment of intelligence and information is a vital part of search action and may be instrumental in modifying probability areas, reprioritising search activities and adopting revised search strategies.

2.8.4 Symbols for use in plotting intelligence information are as depicted in Appendix D-3

Communication Checks

General

- 2.8.5 Communication checks are conducted by the SMC when information, in addition to the initial report, is required. A most common situation is where the target is overdue or unreported. It is the time when detective work is required of the SMC. Communication checks may be conducted prior to, during or after dispatching search assets, depending upon the urgency of the incident.
- 2.8.6 Communication checks involve not only extensive use of various networks to provide additional information, but also may involve physical checks of areas where the target may be located. Generally the purpose of communication checks is to continue efforts to contact the target, to determine if the target is overdue or unreported, to localise the search area, and to get more factual data for evaluation of subsequent SAR action.
- 2.8.7 Initial communication checks may consist of contacting and checking major facilities within the areas where the target might be or might have been seen, and is normally conducted during the uncertainty phase. These checks should have a reasonably effective probability of locating the missing target within a short period of time, if the target is merely unreported rather than actually missing.
- 2.8.8 Where initial checks fail to locate the target, communication checks are to be expanded to check a wider variety of possible sources of information on the missing target, including physically checking possible locations, such as car parks, harbours, marinas and airports.

Communication Checks for Marine Craft

- 2.8.9 Communications checks for marine craft may include the following:
- a) Satellite and radio communications.
 - b) Inquiries should be made to the facilities in locations that will give reasonably thorough and rapid coverage of the area such as:
 - i) Port authorities.
 - ii) Marinas, yacht clubs and other water-side facilities.
 - iii) Fishing cooperatives.
 - iv) Harbour masters.
 - v) Volunteer organisations.
 - vi) If the missing craft is known to have a radio aboard, contact by Coast Radio Station.
 - vii) Vessel/boat owners or agents.
 - viii) Police.
- Note:** Marine checks should be forwarded through the closest Water Police as they have extensive contact list for Marine facilities. Contact and requests should be noted in running logs.
- ix) Customs, Immigration (if applicable).
 - x) Relatives, neighbours and associates.
- c) Check and confirm departure and reported non-arrival and request the RCC be notified immediately if it does arrive.

Communications Checks for Aircraft

- 2.8.10 When an aircraft subject to a SAR watch fails to report by a prescribed time, or if an aircraft fails to report, the responsible ATS unit shall:

-
- a) Attempt to contact the aircraft direct by calling on normal and alternative frequencies.
 - b) Attempt to contact the aircraft via another aircraft.
 - c) Ascertain whether another asset has received the report.
 - d) Arrange for other ground asset to call the aircraft on normal or alternative frequencies.

Actions by JRCC Australia

2.8.11 JRCC Australia will conduct checks by:

- a) Contacting the aircraft/vessel operator and destination and alternative airports/ports to confirm that the aircraft/vessel has not arrived.
- b) Having physical checks of aircraft parking areas and hangars conducted at uncontrolled airports and airfields.
- c) Having physical checks of harbours and/or loading facilities at uncontrolled locations (may vary depending on vessel size).
- d) Thoroughly evaluating the flight/vessel plan, weather, terrain, sea conditions, possible communication delays, last known position, text of radio calls, pilot/master qualifications, and the performance of the aircraft/vessel under favourable conditions.
- e) Compute the time of fuel exhaustion if not done earlier.
- f) Notify the operating agency of the aircraft/vessel.

Crashed Aircraft

2.8.12 When it is known that an aircraft will crash or has crashed and the crash position is incidentally reported or known with reasonable certainty, the RCC is required to confirm the crash site and ensure the provision of medical assistance and rescue of the survivors.

2.8.13 Pending assumption of the responsibility for the wreckage by ATSB or the relevant military authority, the RCC shall endeavour to arrange a guard at the crash site to prevent interference with the wreckage or with marks made by the aircraft in landing. State/Territory police customarily act as guards. Aircraft crashes that involve fatalities are to be treated as crime scenes from the outset and once survivors have been checked with minimal disruption to the scene, the RCC's responsibility ceases and the scene is then subject to investigation by State/Territory police under the State/Territory coronial legislation and/or ATSB.

Health Hazards - Aircraft Accidents

2.8.14 Movement in the vicinity of crash sites can be extremely hazardous for ground parties. Details of these hazards can be found in Appendix D-8.

Intelligence gathering

2.8.15 Type of Information:

- a) Missing target (aircraft, vessel, and person). As much information as possible regarding the target(s) needs to be obtained.
- b) Objects: When conducting a search for an object such as aircraft, vessel, vehicle, or any other article, it will be necessary to gain a complete description of the object.
- c) Weather: It is of vital importance to gain knowledge of weather conditions that have or are likely to prevail in the area of search prior to, during and in the immediate future. In extremes, this will indicate the possible time frame for any involved person's survival.
- d) Area of Search: The success of an operation will depend to a large extent upon accurate prior knowledge of the area/locality to be covered. It will be necessary to have knowledge of:
 - i) General sea conditions and topography;

-
- ii) Known problem areas;
 - iii) Hazards and terrain;
 - iv) Sea state/foilage/ground cover; and
 - v) Rendezvous points.
- 2.8.16 Therefore it is desirable that an area reconnaissance be carried out as early as possible.
- a) Resources. The resources for the search operation will be those made immediately available by the responding organisations and may be supplemented by those obtained by the Commander. These resources are basically in two groups:
 - b) Personnel. Information should include:
 - i) Number available;
 - ii) Experienced/inexperienced;
 - iii) Capability and response considerations
 - iv) Time available; and
 - v) Special requirements (e.g. mountain rescue).
 - c) Equipment. This may include:
 - i) Vehicles;
 - ii) Vessels (Inshore and off shore);
 - iii) Aircraft;
 - iv) RPAS (Drones);
 - v) Radios;
 - vi) Electronic aids (Tracking devices, mobile telephone locators, etc.);
 - vii) Maps, charts and plotting equipment; and
 - viii) Special equipment.
- 2.8.17 With regard to resources, the appropriate allocation may determine the success of the operation, whilst it should be recognised that the quality of resources, both personnel and equipment, may decrease with time.
- 2.8.18 Availability and access of information: Having detailed the type of information required, there are three factors to consider:
- a) Where can the information be obtained?
 - b) How may the information be accessed (e.g. medical records)?
 - c) How much is enough?
- 2.8.19 Sources of Information:
- a) About Missing Persons (whether from vessel, aircraft or missing): Sources of quality information may include:
 - i) Family;
 - ii) Friends;
 - iii) School;
 - iv) Employer;
 - v) Family doctor;
 - vi) Last known contact;

-
- vii) Hospitals/medical centres;
 - viii) Public transport companies;
 - ix) Social media; and
 - x) Mobile telephone tracking.
- b) About Aircraft/Vehicles/Vessels/Objects: Information sources may include the:
- i) Owner;
 - ii) Operator;
 - iii) Manufacturer; and
 - iv) Industry.
- c) About the Weather: Sources may include:
- i) Bureau of Meteorology;
 - ii) Local knowledge;
 - iii) Local records;
 - iv) Experience;
 - v) Electronic sources and archives; and
 - vi) Reconnaissance teams.
- d) About the Area: Sources may include:
- i) Maps (topographic, parish, forestry);
 - ii) Charts (RAN, RN, etc.);
 - iii) Electronic (Google maps, Google Earth, satellite images);
 - iv) Sketches;
 - v) Local knowledge;
 - vi) Aerial photographs; and
 - vii) Reconnaissance.
- e) About Resources: Sources may include:
- i) Police;
 - ii) Emergency services;
 - iii) Volunteer services (SES, Coast Guard, Volunteer Marine Rescue);
 - iv) Bushwalking club;
 - v) Defence services;
 - vi) General aviation;
 - vii) Community facilities/organisations; and
 - viii) Media.

- 2.8.20 Evaluating Information: The SMC must consider the traits of the missing person, vessel or aircraft, together with the merit of all available information, to predict the person's possible movement, or to reduce the area of probability.
- 2.8.21 Because total required information will not be available prior to commencing a search, information-gathering and evaluation will be continuous throughout an operation.
- 2.8.22 On evaluating the information the SMC will need to make some judgment of the urgency or severity of the situation and whether to take any action or not. A useful aid in coming to this decision is the Search Urgency Form, located at Appendix E-1.

-
- 2.8.23 Search Information Phases: The phases for gathering search information include the following:
- 2.8.24 Pre-Search Phase (Collection, collation, evaluation): In the period between raising the alarm and the actual beginning of the search, as much relevant information as possible needs to be acquired and evaluated. The assessment of information is described earlier in this chapter and this may determine that an alarm has been raised prematurely and the search should be delayed or cancelled, or it may reinforce the sense of urgency due to factors such as:
- a) Missing person's physical or mental condition (experience, capability, preparedness);
 - b) Vessel, vehicle or aircraft mechanical condition
 - c) Weather conditions; or
 - d) Sea conditions or terrain in the area.
- 2.8.25 Briefing Phase (Dissemination) - The decision to mount a search has been made and search assets are being prepared to commence the operation. Pilots, masters, and team leaders are required to attend a briefing at which orders will be given regarding the conduct of the search. Details that need to be covered are:
- a) Briefing needs to be in the SMEAC format, standard among SAR assets;
 - b) Information relevant to the missing target;
 - c) The area to be searched;
 - d) The recommended search pattern;
 - e) The command and communications system; and
 - f) Any special instructions (the method for producing orders and conducting briefings is described in Volume 2, Chapter 4.10 & 4.17).
- 2.8.26 All this information must be clearly and fully understood by the participants. The omission of a single item of information may lead to an unsuccessful search conclusion.
- 2.8.27 Search Operations Phase - In the conduct of the operation, the search assets must constantly seek and provide further relevant information. This may be provided in the form of:
- a) Location of physical clues;
 - b) Information from persons in the area;
 - c) Interpretation of topographical factors; and
 - d) General experience.
- 2.8.28 All such information needs to be evaluated and passed to the RCC. Information acquired by this means may dictate the future course of the search. A sample Team Task Sheet is shown in Appendix E-14.
- 2.8.29 Debriefing Phase (Collection, collation, evaluation, dissemination)—As search assets return to the RCC, pilots, masters and team leaders need to be debriefed. Care needs to be taken that all relevant information is gathered and then re-evaluated as the situation develops.
- 2.8.30 This information will then be distributed to assets still searching or before new assets are deployed.

Sighting and Hearing Reports

- 2.8.31 When even an approximate position of a missing target is not known, it is usual to arrange for media broadcasts to be made requesting information from members of the public who may have seen or heard the target.
- 2.8.32 In composing a message for broadcasting, some significant feature of the target should be omitted from the description, thus enabling a better assessment to be made of the validity of

reports received. Care should be taken in specifying the call-in telephone number to avoid engaging vital RCC lines. Having available a dedicated intelligence telephone number is recommended.

- 2.8.33 The aim of a broadcast is to promote the best reception of Sighting and Hearing reports from a defined area. The SMC, or delegate, will contact the Police headquarters or operations centre in the relevant State or Territory capital and discuss an intention to request public assistance.
- 2.8.34 The SMC will discuss the area to be covered by the broadcast, the frequency of the broadcast and its duration. The SMC should be very specific about the area to be covered by the broadcast. Radio provides the quickest local coverage. Television may be very complicated and difficult to handle. Copies of all broadcasts are to be provided to the relevant police centre.
- 2.8.35 The SAR authority should be informed when a broadcast is issued. When the Media/PR officer is present in the RCC, it may be more advantageous and expeditious to have them request a broadcast to a local station. If this occurs the police shall be advised.
- 2.8.36 If appropriate, a sighting/hearing cell will be established to receive, plot and assess the information.
- 2.8.37 RCC staff should be prepared to receive a large number of reports in the period immediately following a broadcast. A Sighting and Hearing Report should be completed for each call taken. Each report should be immediately entered in the Sighting and Hearing Log and the position and details plotted on the relevant map or chart.
- 2.8.38 Sighting or Hearing Report Forms should always be used to record reports of targets being seen or heard to ensure that vital information is not omitted. All sighting and hearing reports are to be assessed by an experienced SAR officer. Guidance on sighting and hearing reports is at Appendix D-4.
- 2.8.39 With respect to aircraft or vessels; to assist in the assessment of reports and to eliminate those that relate to other craft, every effort should be made to establish the movements of all craft that would have been operating in the same general area as the missing target in the same time period. A general description of such other craft, including their colour schemes, is necessary to assist the process of evaluation.

Assessing Reports

- 2.8.40 To assist in the assessment of reports and to eliminate those that relate to other craft, every effort should be made to establish the movements of all craft that would have been operating in the same general area as the missing target in the same time period. A general description of such other craft, including their colour schemes, is necessary to assist the process of evaluation.
- 2.8.41 In addition to seeking reports on the missing target, it may be necessary to broadcast a request for information about, and descriptions of craft that were flying/sailing in the target
- 2.8.42 area at the appropriate time and for which flight/voyage details had not been lodged.
- 2.8.43 Reports that cannot be related to a known movement of craft other than the target shall be individually assessed and categorised as reliable, unreliable or doubtful.
- 2.8.44 A plot should be made of all reports. Those considered to relate to the target shall be highlighted.
- 2.8.45 It may be good procedure to interview the originators of some reports a second time, either to confirm the original details, or to gain additional information.

Interviewing Witnesses

- 2.8.46 Care must be taken in the selection of a person to interview witnesses. Consideration should be given to the use of specially trained officers, e.g. a police officer with SAR training.
- 2.8.47 When interviewing witnesses, the following points should be kept in mind:
 - a) The interview should be conducted as soon as practicable after the event. Many people forget important facts quickly and are influenced by other opinions, press reports.

-
- b) The interviewer should know the subject, be aware of the details reported previously, and have questions prepared in advance to clarify points on which further information is required.
 - c) After identifying himself, the interviewer should explain the purpose of the Interview clearly.
 - d) Persons being interviewed should be asked to give a personal account of events without coercion or suggestion. They may then be asked questions designed to solicit other facts.
 - e) When possible, statements should be tested by related occurrences, e.g. the distance of the target from the observer by weather phenomena such as visibility and cloud base; the time of observation by the extent of daylight, position of the sun or radio program.
 - f) If witnesses are not clear about particular aspects, they may be left to consider the incident further and be given opportunity to contact the RCC should additional information subsequently come to mind.
- 2.8.48 Reports assessed as reliable may form a basis for modifying or extending the probability area. SMCs should, however, guard against neglecting the search of previously established search areas merely on the basis of such reports. Many compelling reports from the public have proven insubstantial.

Coordination with the Police

- 2.8.49 It is possible that the police will receive incidental reports from the public that may be of value to the search effort. It is essential that the police in the search area are made fully aware of the search activity and the need to pass all relevant reports and information to the RCC as soon as possible.

Examination of Recorded Communications - Aircraft and vessels

- 2.8.50 At an early stage in the search action, communication records shall be examined for any data relating to the missing target.
- 2.8.51 RADAR and recordings of frequencies used or possibly used by the missing target shall be replayed.
- 2.8.52 A discrete recording should be made of exchanges between the target and other craft and ground stations during the time of flight/voyage. The recording should then be made available to the RCC.
- 2.8.53 When a target disappears without a distress call having been received on the communication channels in primary use, requests should be made to other assets to have recordings and written records examined to determine if transmissions were recorded from the target on any other channels.
- 2.8.54 The assistance of specialist communication staff may be sought for transcription of dialogue from recordings.

Flight Path Analysis - Aircraft

- 2.8.55 In addition to information reported by the public, it is often possible to reconstruct a probable flight path from information contained in the flight plan and reports to ATS units of the targets flight's progress.
- 2.8.56 A detailed study of all available navigational data should be made. Particular attention should be directed to the pilot's application of variation and calculation of headings and speeds.
- 2.8.57 Mistakes have also commonly resulted from differences between forecast and actual weather, so contact with the BOM is of vital importance.

Weather Analysis

- 2.8.58 An analysis of the weather existing at the time a target encountered difficulty and the interaction of weather and terrain or sea conditions should be made. The opinion of meteorologists should be sought in this respect, as should the views of suitably experienced qualified mariners, pilots and land search experts.
- 2.8.59 Effort should be made to obtain reports of conditions in flight, at sea or land areas from mariners, pilots or others who were in the area at the time the target encountered difficulty.
- 2.8.60 It is conceivable that a likely plan of action adopted by the distressed master, pilot, skipper, etc. can be deduced from these data of intelligence; decisions regarding priority of search effort may follow.

Logistical Information

- 2.8.61 Depending on the target, the Intelligence Cell may consider obtaining data on the following resources:
- a) Suitable landing and anchorage areas.
 - b) Fuel and other asset replenishment supplies.
 - c) Aircraft, vehicles and marine craft suitable as rescue assets.
 - d) Shipping resources and facilities, should the search be over water.

General Considerations for the SMC

- 2.8.62 SMC duties can be demanding. The gathering of information, evaluation of this information and initiation of action all require concentrated effort on many details. The SMC will find the various forms, checklists, worksheets, tables and graphs provided in the appendices to be very helpful. The following paragraphs provide some general guidance for the early stages of a SAR operation, including information gathering and preparation for the possible need to plan searches.
- 2.8.63 Several factors will influence the extent and manner of an initial SAR response. In general these are:
- a) Extent and reliability of information about the location of the target and its occupants.
 - b) Availability of aircraft, marine craft and land parties for searching.
 - c) Actual and forecast weather conditions.
 - d) Times of daylight/darkness.
 - e) Nature of terrain, topography, sea conditions, current, winds and other meteorological events.
 - f) Availability of survival supplies and supply dropping teams.
 - g) Sea currents.
 - h) Time delay in notification.

Urgency of Response

- 2.8.64 Evaluating incidents to determine the urgency and the extent of required SAR response, or the termination of response is a function requiring information, judgement and experience. In emergency situations requiring immediate assistance, the action taken must be accomplished quickly and positively. Where uncertainty exists, evaluation is usually more difficult and time consuming because of the many factors involved.
- 2.8.65 Perhaps the most difficult task the SMC undertakes is the evaluation of these factors. They usually become apparent between the time the incident is reported and the execution of the

search. This is a time when speed and reliability will be most important, however it is also a time when incident reports may be incomplete or confused.

- 2.8.66 The most serious limitation is time. When persons are injured or are subjected to adverse climatic or water conditions, the chances of survival decrease rapidly. Time limitation also may be dictated by the number of hours left for a daylight search, although the SMC should not arbitrarily rule out night search, especially in unpopulated areas, over the ocean, and over flat terrain or deserts.
- 2.8.67 The facilities available to conduct a search may be limited by lack of available personnel and search assets. The SMC must be aware of availability of SAR facilities within their region.
- 2.8.68 Terrain, weather and oceanographic conditions can affect all areas in SAR planning and operations. Search visibility, aircraft limitations, search effectiveness, safety of flight and time available to complete the search are some of the factors that will affect search capability.
- 2.8.69 Whenever practicable, pertinent data should be plotted on a map/chart to aid in evaluating related factors. never practicable, pertinent data should be plotted on a map/chart to aid in evaluating related factors.
- 2.8.70 Normally the SMC determines the urgency and extent of SAR services required for an incident. A rapid but systematic approach is essential since prompt response to emergency incidents is the essence of the SAR system.

General Time Factors

- 2.8.71 The probability of finding survivors and their chances of survival diminish with each minute after an incident occurs. Prompt positive action is required so that no life will be lost or jeopardised through wasted or misdirected effort. Individual incidents will vary with local conditions such as terrain, climatic conditions, ability and endurance of survivors, emergency equipment available and SAR assets available to the SAR system.
- 2.8.72 In the case of seriously injured survivors or survivors in a hostile environment, the reaction time of the SAR system must be measured in minutes. Critically injured survivors of any accident usually die within the first 24 hours if not given emergency medical care.

Daylight Factor

- 2.8.73 For survivors not equipped with any type of detection aids daylight visual search is usually the only search method available to the SMC. If darkness were approaching this would be another limiting factor for the SMC to consider.

Night Factor

- 2.8.74 If it is known or suspected that the survivors have detection aids such as pyrotechnic flares or other night signalling devices or can display other lights, night searches should always be conducted. Night searches, visual and electronic are particularly effective at sea, over sparsely populated areas, flat terrain and deserts.
- 2.8.75 Night aural and visual search should be considered. Modern electronic detection methods may be effective in locating targets. The capability of these devices should be discussed with the operators of the equipment. Consideration should be given to the use of Night Vision Goggles (NVG) or Forward Looking Infra-Red Radar (FLIR) particularly when searching from the air.

First and last search light

- 2.8.76 First and last search light describes the optimal times that searching should commence and cease taking into account the angle of the sun and the limiting factors caused by a low sun on searchers. First search light is 45 minutes after sunrise and last search light is 45 minutes before sunset. These times allow for the sun to either rise above the horizon sufficiently for searching towards the east, or to be sufficiently above the horizon for searching towards the west. In mountainous or built up areas these times may vary due to darkness extending for lengthier

periods. Given the urgency and circumstances a SMC may choose to utilise these times to conduct searches.

- 2.8.77 Civil twilight is that period of time when the sun is 6° (24 minutes) below the horizon, either before sunrise or after sunset. This time can be utilised by aircraft to travel to their respective search area, but originally related to when a star sighting could be taken from an aircraft.
- 2.8.78 Nautical twilight is that period when the sun is 12° (48 minutes) below the horizon, either before sunrise or after sunset. This time can be utilised by vessels to travel to their respective search area but originally related to when a star sighting could be taken from a ship.

Weather/Oceanographic Factors

- 2.8.79 It is of vital importance to gain knowledge of weather conditions that have or are likely to prevail in the area of search prior to, during and in the immediate future. In extremes, this will indicate the possible time frame for the missing person's survival. Adverse weather prevailing in or approaching an area where survivors are located may also limit the time available to conduct a SAR operation. Not only are survivors of an incident more difficult to detect under adverse weather conditions, but also SAR assets themselves operate at lower efficiency due to conditions and higher stresses on the search personnel.
- 2.8.80 Accurate knowledge of weather conditions and the prudent judgment based on it will enhance the likelihood of a successful mission. Knowledge of the prevailing weather conditions will also play an important role in the safety of the search assets.
- 2.8.81 If weather will not allow for a search operation to be mounted without endangering additional lives, the search effort should be deferred or suspended. If weather is currently good but forecast to deteriorate in a short time, more rapid action is required and detailed planning may suffer due to the time available. If weather is good and forecast to remain so, more extensive planning may be accomplished.
- 2.8.82 Wind, visibility and cloud cover influences the search track spacing. Therefore, the better the weather information, the more realistic will be the derived track spacing. Maintaining accurate search patterns is difficult in adverse weather. Aerial assets are particularly vulnerable. For this reason the patterns selected should allow for more precise navigational accuracy.
- 2.8.83 Safety may sometimes be prejudiced by actual weather conditions, which must, therefore, be monitored continuously by the SMC. Low cloud base and restricted visibility are particularly hazardous during searches that cover large areas where many aircraft are employed. Should an aviation search be conducted under adverse weather conditions that deteriorate below the required flight conditions, then the aviation search may have to be suspended.
- 2.8.84 In situations where survivors are adrift in regions of high velocity water current, searches should be mounted without delay. The probability of locating survivors is high during the early stages of survival craft drift as the drift factor allowed for in search calculations will be of reasonable accuracy over a short time period.
- 2.8.85 When missions involve overdue craft, the weather situation should be evaluated to determine what effect it may have had upon the craft's operating capabilities and/or the actions of the craft's operator prior to SAR system activation. To obtain an overall weather picture an attempt should be made to complete the following questionnaire:
- a) What was the weather at the departure point, destination and along the planned track at the time the overdue craft should have been in those areas? If no established weather facilities are available, the information should be obtained from local reliable sources in the areas concerned, such as police or marine volunteers, if possible.
 - b) What was the en-route and forecast weather briefing given to the crew of the missing craft, and what was the operator's reaction to the weather briefing?

-
- c) What was the weather in the area where the missing craft is presumed to be and if the time of emergency is known, what were the actual weather conditions at the craft's estimated position?
 - d) Were there any marked changes in wind or sea currents that might have resulted in navigation errors?
 - e) Were there any areas of low ceiling, poor visibility, precipitation, thunderstorms, frontal activity, turbulence, icing, that may have caused the craft to attempt circumnavigation, or that could have exceeded either the crafts or operator's capability?
 - f) Were there any areas of marked pressure changes that may have caused aircraft altimeter errors?

Terrain Factors

- 2.8.86 Terrain may be a major factor in evaluating an incident. Terrain may dictate the type of search pattern required, and may limit the selection of search aircraft that can be used. Aircraft that are highly manoeuvrable and will be effective at moderately high altitudes may be required in rugged mountain areas. High performance or large transport aircraft may be unusable in confined areas and helicopters may not be able to operate in the thin air and turbulence associated with mountains and contour searches.
- 2.8.87 Terrain may also limit the time available for search. For example low-level searches in mountain areas are normally limited to daylight only, often restricted by increased shadows due to deep valleys and high mountains. The type of survival kit carried by the target and the equipment, such as the type of hoist device used by available helicopters will also be influencing factors. Dense foliage may hamper both visual and electronic searches and require increased numbers of aircraft and closer search track spacing.
- 2.8.88 Man-made additions to the terrain such as power-lines, towers and bridges must also be considered when planning search areas and the altitudes of search aircraft.
- 2.8.89 The type of rescue team used after the distress site has been located is also dependent upon terrain. When there is doubt about survivors or the area is inaccessible, time is a factor. Should other help not be readily available, airdrops or parachutists may be required. Before deploying parachutists, the ability for them to land, to be resupplied and recovered must be considered.

Available Search Asset Factors

- 2.8.90 During the prosecution of any SAR mission the SMC will have assets at their disposal whose primary mission is not SAR but who have SAR capabilities.
- 2.8.91 It is of primary importance that the SMC fully understands the limitations of all facilities available in their region if they are to be effectively used. The number, types, equipment and experience of available search assets will limit the courses of action available to the SMC.
- 2.8.92 In addition there may be instances when all available crews are either committed to other operations, in the case of flight crews or have expanded their maximum authorised crew duty time.
- 2.8.93 Some time is usually required for a suitable SRA to arrive on-scene, therefore search assets maximum speed for short distances or normal cruising speed for long distances is a factor. The SRA's range will determine both the maximum distance it can proceed from its operating base and its on-scene endurance. The SRA's communication capability for working with the SMC, other search assets and the target must be considered.
- 2.8.94 The SRA's navigation capability will influence the areas to which it can be assigned, since accurate navigation in search areas is essential for effective coverage.

-
- 2.8.95 The SRA may carry detection sensors and its ability to carry equipment that may be required on-scene should be considered. However, operating limitations of the search asset will override all other factors. These include such things as turbulence, icing and instrumentation for aircraft, and sea-keeping qualities for vessels and small craft.

Survival Equipment Factors

- 2.8.96 The amount and type of survival and signalling equipment available to the survivor will influence not only the urgency of the SAR system's response, but also the methods and procedures employed in various SAR stages.
- 2.8.97 The SMC may concurrently conduct a high level electronic search and a visual search. The SMC must use their common sense, good judgment and background experience to evaluate the appropriate response for taking advantage of the survivor's capability to signal and survive.

Risks v Gain Factors

- 2.8.98 SAR assets are responsible for taking whatever action they can to save life at any time and place where their facilities are available and can be effectively used. Nevertheless, there may be a point beyond which SAR services are not expected and cannot be justified. Known and inherent risk must be carefully weighed against the mission's chances for success and the gains to be realised.
- 2.8.99 SAR personnel and equipment shall not be placed at risk, nor the mission attempted, unless lives are known to be at stake and the chances for saving lives are within the capability of the personnel and equipment available.
- 2.8.100 All reasonable action shall be taken to locate distressed personnel, determine their status and bring about their rescue. Prolonged SAR operations after all probability of survival has been exhausted are uneconomical and not warranted. The decision to conduct such operations must be based on probability of detection.
- 2.8.101 Studies have shown that the period within 12 to 24 hours of a distress incident is the most critical for recovery of survivors. The best chance of successful recovery occurs during this time period. Within 48 hours, chances are still good, but after that time the chance of successful recovery decreases rapidly.

Chapter 3 Search Planning and Evaluation

3.1 Aviation and Maritime Search Planning

Overview

- 3.1.1 The wellbeing of survivors is critically dependent on early location and support. It is vital that as soon as possible after becoming aware of an incident, SAR authorities quickly implement procedures for a rapid search of the most likely area of distress. In general, the initial SAR response requires ready application of simple procedures to quickly cover the most likely area of distress. The search area described will be of rudimentary construction, e.g. a circle, square or rectangle depending on the nature of the target. The stage 1 search area (equivalent to a Reflex search on land) will be of sufficient proportions to cover all reasonable alternative tracks of the target and will incorporate areas highlighted by intelligence information. This strategy precedes the more complex calculations that will give rise to a more precise area which, failing the success of stage one search will form the basis for a formally planned and executed action at a later time. The stage one search may be undertaken in relatively short time and allow ready allocation and briefing of the few necessary resources.
- 3.1.2 All of the basic search theory concepts are described in this chapter. Practical examples are provided for each concept, showing how it may be applied to the search-planning problem. These examples require only basic arithmetic skills and an understanding of the basic probability concepts encountered in everyday life. Although search planning may be perceived to be complex, each step is relatively simple.

Note: It is essential when planning commences for search operations that rescue planning is commenced as outlined in Volume 2, Chapter 5. This is to occur as a concurrent action. Rescue planning forms an integral part of the Search Planning.

3.2 Aviation and Maritime Search Planning Steps

- 3.2.1 Search planning involves the following steps:
- a) Evaluating the situation, including the results of any previous searching (This may include incidents that have occurred in that location in the past and search efforts on previous days);
 - b) Estimating the distress incident location and probable error of that location;
 - c) Estimating the survivors' post-distress movements and probable error of that estimate;
 - d) Using these results to estimate the most probable location (datum) of survivors and the uncertainty (probable error of position) about that location;
 - e) Determining the best way to use the available search assets so the chances of finding the survivors are maximised (optimal search effort allocation);
 - f) Defining search sub-areas and search patterns for assignment to specific search assets; and
 - g) Providing a search plan that includes a current description of the situation, search target description(s), specific search responsibilities to search assets, on-scene coordination instructions and search asset reporting requirements.
- 3.2.2 These steps are repeated until either the survivors are located or evaluation of the situation shows that further searching would be futile. While the JRCC and the ADF generally cease search efforts upon the Time Frame for Survival (TFFS) being reached, police have obligations under jurisdictional Coroner's Acts to continue searching for, and recovering, deceased persons that were previously the target of a SAR operation.

Evaluating the Situation

- 3.2.3 Searching is the most expensive, risky and complex aspect of the SAR system. Often it is also the only way survivors may be located and assisted. All information received about the incident must be carefully analysed and evaluated before a search is undertaken and at frequent intervals during its progress. In the early stages of a SAR incident, it is almost certain that the SMC will need to make some assumptions about the nature, time or place of the incident. It is very important that such assumptions be kept separate from the known facts. It is important to distinguish conclusions based on known facts from those based partially on assumptions. It is also important to re-evaluate all assumptions regularly and as new information becomes available. Any assumption, which is allowed to go unquestioned for too long a period, begins to falsely assume the appearance of fact, and can compromise the search effort.
- 3.2.4 Some of the clues that may indicate the survivors' location or situation include:
- Intentions;
 - Last known position;
 - Hazards;
 - Condition and capabilities;
 - Crew behaviour;
 - On scene environmental conditions; and
 - Results of previous searching.

Estimating the Distress Incident Location

- 3.2.5 The first step in search planning is to determine the limits of the area containing all possible survivor locations. This is usually done by determining the maximum distance survivors could have travelled (by aircraft, vessel, vehicle or on foot), or survivors in the water might have drifted, between the time of their last known position (LKP) or splash point (SP), and the known or assumed time that search assets can reach the commence search point, by drawing a circle with a radius equal to that distance around the LKP (S/T/D calculation) or SP. Knowing the extreme limits of possible locations allows the search planner to determine where to seek further information related to the target and whether any incoming intelligence might apply to the incident. This initially may result in a very large search area that may be too large to search with the available resources. Therefore, the next step is to develop one or more scenario/s or sets of known facts plus some carefully considered assumptions, describing what may have happened to the survivors since they were last known to be safe. Each scenario must be consistent with the known facts of the case, have a high likelihood of being true and allow the search planner to establish a corresponding geographic reference or datum for the survivors' most probable position (MPP).
- 3.2.6 Three possible situations may exist with respect to the location of a distress incident when it is reported.
- 3.2.7 **Approximate Position Known.** The incident may have been witnessed: reported as a navigational fix by another craft or the target in distress; or computed by the SMC as a dead reckoning position from a previously reported and reliable position of the target in distress (manually or electronically).
- 3.2.8 **Approximate Track Known.** The target in distress may have filed a trip or voyage plan prior to departure that included the intended track or route but the target's actual position along the track is unknown. A single line of position, such as a flare sighting or DF, should be treated the same as a track known situation.
- 3.2.9 **Approximate Area Known.** When neither the position nor the intended track is known, at least an area that the target in distress was probably within can usually be determined. The SMC

should try to reduce this area to an area of high probability that can be used as the initial search area or, if the area is small enough for adequate searching with available assets, use it.

Datum Considerations

- 3.2.10 The datum is the geographic point, line or area used as a reference in search planning. A datum for the initial distress incident is first estimated from the known facts of the case and possibly some assumptions that have a high likelihood of being true. This datum for the distress incident is then adjusted to account for estimates of post-distress survivor motion, either through effects of drift or possible movement of survivor over land, at any particular moment during the incident. Finally, the level of uncertainty about the new datum is evaluated and limits are estimated for the smallest area containing all possible locations consistent with the scenario on which the new datum is based. This area is called the possibility area for that scenario.
- 3.2.11 **Datum:** The first step in search planning is to determine Datum. Datum is a calculated reference for the possible location of a target allowing for all environmental factors, and forms the basis for all marine and aviation search drift modelling. Datum calculations begin with the reported position of the SAR incident. The initially reported location may be a point, a line or an area. The 'position known' category are the reported positions of vessels sinking, boat's engine breakdown, sailboat's dismasting, man overboard, etc.
- 3.2.12 A **datum point** is the most probable location of the target, corrected for drift, calculated for a specific time. It is only possible to determine a datum if an origin location is known.
- 3.2.13 A **datum line** is the line connecting two or more datum points computed for the same specified time, along which the search object is assumed to be located with equal probability. The most common instance when a datum line is developed is when the initial location reported of the search object falls within the trackline - known category. Datum lines are also developed when there is a known start and end point in a vessel/aircraft's route, with drift calculated off that base line.
- 3.2.14 A **datum area** is an area in which the search object is assumed to be located with equal probability throughout the area. A datum area is most often necessary in those incidents in which there is no initial position or trackline known.
- 3.2.15 Datum is computed periodically during a search incident when drift forces continue to affect the position of the search target. Updated datum are usually labelled sequentially: - Datum1, Datum2, Datum3, etc. A new computation is required on each asset tasking or at regular intervals during a SAR incident. Drift should also to be validated against local environmental data when available. This allows for the movement of the water through a search area and ensures assets are searching the correct area in relation to LKP.

Drift Considerations

- 3.2.16 Drift is vector movement, (direction and distance), of the search target caused by momentum, drag, wind, water and other external forces. Drift may be spoken of as individual drift (d), which is the drift occurring in a specified time interval (t); or may be spoken of as a total drift (D), for a specified clock time or total elapsed time since the incident occurred (T). Total Drift (D) of a search object is the vector sum of all the individual drifts accumulated during an incident, from the elapsed time since the search target was first exposed to any external forces which cause drift movement, to the time of the latest computed datum.
- 3.2.17 Both total drift and individual drifts may be given subscripts to indicate their specified time or time intervals e.g.: 'ds 1500' is sinking drift for 3.00pm.
- 3.2.18 Drifts caused by wind and water currents must be continually recomputed during an incident to correct the datum as the errors become greater with the passage of time.
- 3.2.19 External forces may move a distressed target or distressed person away from the initial position of distress. These include such things as water current drifts, leeway, etc.

3.3 Search Response Stages

- 3.3.1 A search typically involves three stages:
- a) Stage 1 - Immediate response. An initial visual and/or electronic search along the missing target's planned route.
 - b) Stage 2 - Nominated area either side of track. Normally a search conducted in an area 10 nautical miles either side of track but this can be varied depending on circumstances.
 - c) Stage 3 - Mathematically derived area. An expanded search of a probability area calculated using the navigational tolerances of the missing and search craft, allowing for drift if applicable and the application of a safety factor.
- 3.3.2 Stage 1 and 2 searches can be run concurrently. By way of example, if a distress incident occurs at the end of daylight or during the night, when the first visual search cannot be undertaken until the following day, then it may be appropriate to conduct both stages simultaneously.
- 3.3.3 Note that an essential part of any search stage will be the establishment of a rescue plan, coordination with the Police and consideration of the early dropping of SAR datum buoys.
- 3.3.4 Some emergency situations will suggest a still more spontaneous reaction. Where a target reports encountering a distress situation, the location is reasonably well known and there are other assets of opportunity in the near vicinity, it may be possible to divert an asset to the area or intercept the distressed target's track with instructions to undertake a track crawl search along the known route.
- 3.3.5 If circumstances allow, the diverted asset may be instructed to proceed parallel to the distressed targets track at an appropriate off-set distance to one side and to return at the same off-set distance on a reciprocal heading on the other side of the targets track. Such a procedure can provide coverage of the distressed target's track and the most likely lateral area either side of it. Whether this is practicable will be dependent on such factors as endurance of the diverted craft, its suitability for the task, weather, daylight and terrain. The pertinent factors should be discussed with the crew of the diverted craft prior to tasking.
- 3.3.6 In other types of situations, a similarly rapid response may be made by tasking an airborne aircraft or one ready for departure at a nearby aerodrome or a vessel to undertake a square or sector search around a known distress position. In any case, the imperatives of this response are:
- a) Rapid assessment of the type of emergency circumstance;
 - b) Early assessment of the most likely position of distress;
 - c) A quick appraisal of readily available assets (from a local facilities or asset register);
 - d) Rapid determination of achievable effort in the prevailing circumstances;
 - e) Consultation with crew well placed to assist;
 - f) Dispatch or diversion of SAR asset(s) without delay; and
 - g) Deployment of rescue platform(s).

Factors Affecting the Search Response Plan

- 3.3.7 There is a wide spectrum of factors that may influence the extent and manner of an initial SAR response. To summarise some of the more important ones:
- a) Extent and reliability of information about the location of the target and its occupants;
 - b) Availability of aircraft, marine craft and land parties for searching;
 - c) Actual and forecast weather conditions;
 - d) Times of daylight/darkness;

-
- e) Nature of terrain; and
 - f) Availability of survival supplies and rescue assets.

Initial Search Procedures

- 3.3.8 When the distress position is not known with certainty, the procedure most frequently used first is to search along the intended track of the missing target. If not already completed, inspection of possible landing places should continue. It may be necessary to allocate one or more aircraft to the task of examining those possible landing areas that have not been inspected during the landing site and communications checks. The size of the area to be considered for this purpose will be at the discretion of the SMC, however, they should be guided in determining final limits to landing site checks by the size of the probability area, modified by any pertinent intelligence information.
- 3.3.9 Unless it is positively determined that the missing target does not have an emergency beacon, information should be obtained from the JRCC on the satellite pass schedule and an aircraft should be quickly allocated to an electronic search. It may be possible to arrange for an electronic search to be flown either before or after some other task but it should be noted that it is not practicable for an aircraft to be tasked for a combined electronic and visual search. All aircraft on visual searches however, as on other tasks, should be briefed to keep a listening watch on 121.5 MHz and 406.0 MHz, but the maintenance of a listening watch will be supplementary to the primary task. Likewise, an aircraft assigned to an electronic search should be briefed to keep a general look out for visual signals if possible.
- 3.3.10 In addition to aircraft being tasked to conduct an electronic search, a general request should be promulgated through Air Traffic Services (ATS) for other non-search aircraft to monitor 121.5 MHz
- 3.3.11 In a situation where a target has been reported missing, the time of the next programmed COSPAS-SARSAT satellite pass from which an ELT/EPIRB/PLB signal radiating from the target area may be received should be established. Otherwise obtain a history of satellite passes for the period the target was known to be in transit.

Possible Location of a Distressed Target

- 3.3.12 If the target is in radio communication, or reports have been received from other sources, the problem of where to search is simplified and may only require the calculation of a DR position. However, should a target disappear without a distress call being received, the following assumptions are made:
 - a) That the target is probably between the last reported position and its destination; and
 - b) That the target is most likely to be found on the section of the planned track between the last reported position and the position where the next report was due.

-
- 3.3.13 The possibility of a communications failure, and a subsequent diversion should not be overlooked. The operating agency, in the event of a commercial target, should be questioned concerning policy as to diversion. In the event of it being a non-commercial or pleasure target, inquiries should be made with family and friends as to possible diversion actions.
 - 3.3.14 New intelligence information may cause the SMC to re-evaluate the assumptions made during the initial planning phase. The possibility of these evolutionary changes to search strategy should not, however, dissuade a SMC from basing initial search procedures on the above assumptions as long as there is, at that time, no indication of contrary tracking by the distressed target.
 - 3.3.15 When conducting an initial response, it is not necessary to draw up a probability area accurately based on the navigational history of the distressed target's route, nor is it normally necessary to take water movement into account, unless the interval between the Last Known Position Time and the estimated time of arrival of search assets at the scene is longer than four hours. This will vary in high drift areas and the SMC may make an arbitrary allowance in the first instance, which may be applied until an accurate probability area is calculated in readiness for a more intensive search.
 - 3.3.16 The terms "Last Known Position" and "Last Known Position Time" are used when referring to last known position and associated times. For simplicity, they are used to describe both land and water positions.

Parachute Drift

- 3.3.17 When an aircraft has been abandoned in flight, consideration must be given to drift when determining the probable location of survivors who have descended by parachute. The displacement from the point at which the aircraft was abandoned can be significant. Advice should be obtained from the military or sporting organisations to assess the drift factor.

Aircraft Incidents

- 3.3.18 Studies of SAR incident data confirm that in a majority of situations in which VFR aircraft have crashed without warning, the distress site has been located within a reasonable lateral distance of the intended track.
- 3.3.19 More precisely, an extensive Canadian study has found that 77% of crashed VFR aircraft flying random tracks, e.g. through mountain valleys and over gaps, were located within five (5) NM either side of track and 87% within 10 NM.
- 3.3.20 With respect to VFR aircraft flying straight line tracks, 79% of crashes were located within 10 NM either side of track and 83% within 15 NM. These statistical distances were from incidents prior to GPS enabled navigation. It could reasonably be assumed that GPS navigation would result in aircraft crashes being closer to the intended track of the target aircraft but there have been not recent studies to confirm this.
- 3.3.21 These statistics may assist in an SMC's decision about the width of the area to be initially searched. In the first instance, the width of area may be dependent upon the number of search hours available from SAR assets. If achievable, a common strategy is to initially search for missing VFR aircraft within 10 NM either side of planned track.

Note: Based on empirical data collected on Canadian inland SAR incidents from 1981 to 1986.

3.4 Aviation and Maritime Basic Search Planning

- 3.4.1 A search plan is required for every mission. It may be an abbreviated plan for a single search asset, or it may be a complex plan involving a large number of assets. In any case, a search plan should always be developed by the SMC, as many lives may depend upon the care with which the search is planned and conducted. When a search mission is required, four factors are of immediate importance to the search asset for conducting their search:
 - a) An adequate description of the search target;

-
- b) The search area, including weather conditions and any possible risks or dangers;
 - c) The best search pattern; and
 - d) The appropriate track spacing.
- 3.4.2 The SMC will most likely provide much more detailed information to the first search asset to be dispatched to the search area, but the above four items comprise a minimum. The SMC develops the original or optimum search plan on the assumption that sufficient and suitable search assets will be available for conducting the operation. Once the optimum plan is developed, the SMC must make every effort to obtain the services of the search assets they need.

Controlling Factors

- 3.4.3 When developing a search plan, the SMC must carefully weigh the limitations of time, terrain, weather, navigational aids, search target detect ability, suitability of available search assets, search area size, distance between search area and SAR asset staging bases, and the particular POD desired under the circumstances.
- 3.4.4 As the ability to survive after an emergency is limited, time is of paramount importance, and any delay or misdirected effort will greatly diminish the chances of locating survivors. While thorough mission planning and good conditions for search are desirable, positive and immediate action is also required. The SMC should exercise best judgement and initiate search with a minimum of information and few SAR assets while additional data are obtained and more extensive search operations are planned.
- 3.4.5 Of all the factors involved in search planning, one or more may prove so important in a particular situation that the others can generally be regarded as secondary or even disregarded entirely. These important factors are referred to as the controlling factors, and are the ones given the most consideration when developing the attainable search plan. For example, when only a limited number of SAR assets are available, the following relationships might exist between datum, search area, time available and probability of detection (POD):
- a) Inaccurate datum requires a larger search area at the expense of time or POD;
 - b) Limited time available for the search requires a rapid search rate at the expense of the POD; and
 - c) High POD requires close track spacing at the expense of area searched or time.
- 3.4.6 The preceding paragraph illustrates a few of the factors that the particular circumstances may dictate as controlling factors. In any of the above circumstances additional SAR assets would alleviate the situation, but (apart from SAR asset availability) there is a practical limit to the number of search assets that can be safely used within a given area. With the realisation that emphasis on any factor will usually be at the expense of others, the SMC must decide which factors are the most important. Once this is decided, the search effort is planned to meet the requirements of the controlling factors, while at the same time satisfying the other factors as much as possible. The ATNPS formula is a useful tool in understanding the relationships between areas covered, time available, number of assets, speed of the assets and track spacing or distance between assets.
- 3.4.7 A controlling factor peculiar to most maritime areas is the drift rate. In situations where a high drift rate is encountered, the SMC must allow for sufficient extension of the search area in the direction of drift in order to prevent the target from slipping out of the area during the search. An alternative to this is to plan smaller successive search areas in the direction of the drift, thereby reducing search legs and ensuring the target remains in the searched area.
- 3.4.8 Search legs must be planned so that the target cannot slip out of the search craft's track spacing during successive sweeps. The simplest and most effective way of accomplishing the latter is to orientate the search legs with the drift direction.

-
- 3.4.9 If the search leg must be oriented across the drift direction, then the search craft should take no longer than 30 minutes to complete each search leg.
 - 3.4.10 To ascertain if the drift rate presents a problem, compare the targets drift rate to the rate of creep of the search aircraft or vessels. If the targets drift rate exceeds the asset's rate of creep, remedial action is necessary. This may take the form of a barrier search at the end of the search area.

Search Effort Expenditure Rate

- 3.4.11 Some situations, such as a declared distress or overdue target, call for an initial maximum search effort over wide areas. However, a maximum search effort cannot be mounted every time a fishing vessel or aircraft is first reported overdue. The great majority of overdue aircraft and small vessel missions can be effectively handled by a planned build-up of the search effort. By using the repeated expansion concept with a small coverage factor, a reasonable build-up of search effort is possible. This build-up of search effort is combined with an expansion of the search area, and reaches the maximum effort and largest area on the last search. At that time, if no contact has been made with the target, the POD will have been strongly established that the target is not visible in the area searched.

Maximum Search Effort

- 3.4.12 When a situation of actual distress is either known or strongly suspected to exist, the time available for search will usually be limited. A maximum search effort must be completed within this time. Quite often a large search area is also involved, further compounding the SMC's problems. The following method has proved successful in approaching this situation:
 - a) Determine a search area that gives a high POD of successfully finding the search object;
 - b) Use a track spacing equal to sweep width ($C = 1.0$, or no lower than 0.5);
 - c) Decide the time by which the search must be completed (available light, first and last search light, electronic searching);
 - d) Select the number of SAR asset hours required to complete one search of the area within the allocated time (refer to the ATNPS formula);
 - e) Dispatch sufficient SAR assets to complete one search of the area within the allocated time; and
 - f) If unsuccessful, expand and/or repeat in accordance with the repeated expansion concept.
- 3.4.13 Do not re-orientate the search or change SAR assets assignments whilst on task if it can be avoided.
- 3.4.14 Once a large-scale search is ordered and SAR assets are dispatched, reorientation of the search area for that particular search is both difficult and wasteful. Planning should therefore be thorough and then adhered to. The SMC must also resist the temptation to re-deploy assets whenever new intelligence or doubtful hearing or sighting reports are received. New intelligence should be evaluated with the possibility that the information needs immediate action. Additional assets should be dispatched to investigate leads that come to light after the assigned assets have commenced searching. This will prevent unsearched areas and maintain the momentum of the search. It is almost impossible to resume a search in an area after that asset has been diverted to another search area. Holes in searches create doubt and reduce the overall POD.

Search Sequence

- 3.4.15 There is no single sequence of search types, search patterns, etc. which can be suggested as standard procedures. The matrix in Table 3-1 shows one search sequence employing various factors and search parameters for an aircraft search. Such a sequence could be used where large areas must be searched initially and search assets are limited. Each incident will require its own

specific sequence and parameters should be recalculated for each search. Searching both a land and marine environment with aircraft provides the most rapid response and greatest chance of survival. In instances where aircraft are unavailable or in insufficient numbers then a vessel search will become necessary in a maritime incident. A vessel search may be limited initially to a trackline search to provide a maximum POD. Vessel visual, electronic, wreckage and beacon searches are limited by the height of eye (Hoe) of searchers and the sea conditions at the time.

Search No	Type	Period	Target	Speed (Kt)	Track Spacing (NM)	Altitude AGL/ AMSL (FT)
Initial	Track line	Day/ Night	Active target	100/200	5	Below 5000
1	Electronic Beacons	Day/ Night	Electronic	150/500	20	High as practicable
2	Visual (aids)	Night	Fires, flares, torch, etc.	100/150	10	1500-3000
3	Visual (aids)	Day	Mirrors, dye, smoke, etc.	100/150	10	1500-2000
4	Visual (rafts)	Day	Life rafts	100/150	1.5	300-1500
5	Visual (wreckage)	Day	Wreckage, survivors	75/130	0.5	200-2000

Table 3-1: Search Sequence (Aircraft)

Notes:

1. Some specialist aircraft may be able to provide RADAR and or electronic sensor searches. This type of search must be considered when conditions are favourable.
2. Searches Initial, 1 and 2 could take place simultaneously at night and 3, 4 and 5 during the ensuing daylight hours; hence all five searches could be completed by the end of a 24 or 36 hour period. Search number is not to be confused with Day number.

- 3.4.16 The most effective search, by far, is an electronic search for a beacon. Electronic searches cover larger areas very rapidly with a high POD. Given that survivors may have illumination aids that assist detection at night by visual or Night Vision Imaging Systems, such as distress flares, lights and fire, a night search can be very effective. The SMC therefore plans to conduct a night search during the first darkness period. The search pattern used should be guided by the search asset crew's expertise in best use of their capability appropriate to the conditions. Since the survivors will be in better physical and mental condition during the early stages of their ordeal, the SMC takes advantage of this by deploying a night search at the first opportunity. This minimises the possibility of the detection aids being lost prior to their use, or of the survivors becoming too weak to use them effectively.
- 3.4.17 The third most effective group of detection aids are the daylight aids such as mirrors, smoke and sea dye marker. The first daylight visual search is therefore based on this group of detection aids. A larger area can be covered initially by using 10-mile track spacing. In addition, the SMC is taking advantage of the probable better physical and mental condition of the survivors, in the same manner as when the early night search for the luminous detection aids was commenced.
- 3.4.18 If in a maritime incident, the electronic search, the night visual search and the day visual search for detection aids are unsuccessful; the SMC must next plan to search for life rafts. Just as the SMC assumed that the survivors were able to use their beacon, luminous detection aids and daylight detection aids in previous searches, he now assumes that the survivors were able to board their life rafts after ditching or abandoning their vessel. Therefore the SMC uses slower aircraft at close track spacing to search visually for life rafts.

-
- 3.4.19 If these raft searches were also unsuccessful, the SMC must then use extremely small track spacing and search for survivors in the water, wreckage and debris. From the second search on, the SMC should have also directed that all SAR assets maintain RADAR search, where RADAR is available, even though the search was planned on the more tangible effective detection aids available to the survivors.

3.5 Aviation and Maritime Determination of Search Areas

Aviation and Maritime Planning

- 3.5.1 Should an initial response fail to locate either the target or its occupants, it will be necessary to plan and execute an intensive search. The planning of a search may be considered under six broad headings:
- Determination of the most probable position of the target and/or its occupants;
 - Delineation of an area large enough to ensure that the survivors are within the area;
 - Selection of facilities and equipment to be employed;
 - Selection of the search procedures to be used;
 - Allocation of search resources; and
 - Preparation for rescue.
- 3.5.2 Additionally, it must be decided what is desirable in terms of search coverage and what may be achievable using available resources.
- 3.5.3 The most probable position (MPP) of a distress incident may be determined from a position reported at the time of the incident, or by the calculation of a DR position.
- 3.5.4 The extent of a search area is based on the accuracy with which the position of the occurrence is known. The SMC should take into account such factors as the possible navigation error of the target and the search craft, meteorological conditions, and drift of the target or survivors if in the water.
- 3.5.5 When the location of a target is not known, a reconstruction of the probable route and some estimation of the most likely position of the incident must be made by the RCC.
- 3.5.6 Two concepts of value in SAR Planning are the Possibility Area, and the Probability Area.

Possibility Area

- 3.5.7 The possibility area is the area in which a missing target could be located. Usually the area is too big to be considered the search area but knowledge of its extent and boundaries may be of use when assessing intelligence information, in particular sighting or hearing reports.
- 3.5.8 The possibility area is displayed as a circle drawn around the last known position (LKP) of the target. The radius of this circle should equal the endurance at the time of the LKP expressed in terms of distance and taking into account wind velocity for aircraft or drift for vessels. It is assumed that the target may have proceeded in any direction until its fuel was exhausted.
- 3.5.9 The possibility area may be determined by:
- For aircraft, drawing a wind vector downwind from the LKP to a scale representing a distance equal to the wind speed multiplied by the known or estimated remaining fuel endurance time, while for vessels, drawing the drift for the time period since the LKP; then
 - Drawing a circle from the end of the wind vector or drift, of a radius (using the same scale) representing a distance equal to the aircraft TAS or vessel speed multiplied by the known or estimated remaining fuel endurance.

- 3.5.10 Figure 3-1 shows the possibility area for an aircraft with a last known position of A. Position B is the aircraft's datum once the wind vector has been applied. The circle is derived using a radius, centred on B, of the aircraft's remaining endurance, which in this example is 150 NM.

Where: A = LKP, TAS = 100kt, W/V +180/15 (Wind vector is 180°T (Blowing from the south) at 15kts), Endurance remaining at A = 90 minutes. Therefore A-B = 22.5 NM (15kt winds x 90mins endurance (1.5hrs)) and radius B-C = 150 NM (100kt speed x 90mins endurance (1.5hrs)).

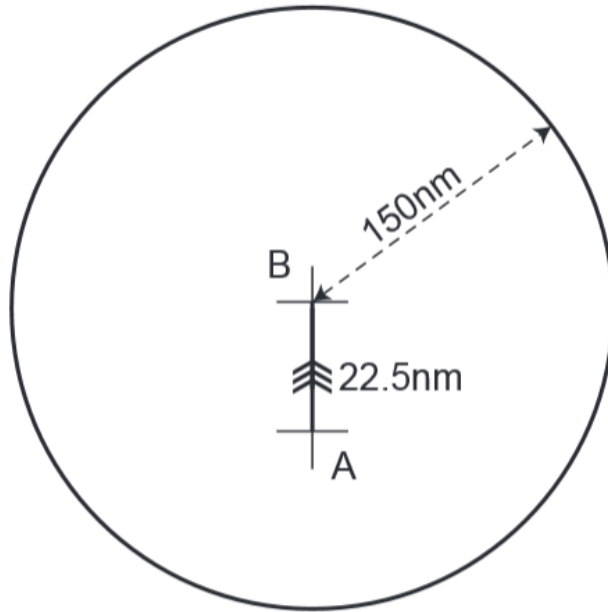

Figure 3-1 Possibility Area

- 3.5.11 The probability area is the area in which a missing target and/or survivors are most likely to be found, taking into account possible errors in the navigation of the missing target and of the search asset, together with an allowance for any water movement (should the incident occur on or over water) and a safety factor.
- 3.5.12 When the position of an incident is reported by a witness, or reported as a navigational fix determined by RADAR or another craft or by the target itself, or calculated by the RCC in the form of DR position, the probability area is enclosed by a circle of probability centred on that position, taking into account the applicable above mentioned factors.
- 3.5.13 In the case of a downed aircraft (see Figure 3-2), joining lines 10 NM either side of the aircraft's known, planned or suspected route will normally form the initial probability area for an aircraft search. The 10 NM may be adjusted to allow for the type of flight, e.g. a transiting helicopter may be 5 NM either side of track where as a turbo prop or jet aircraft may be 15 NM or more. This is referred to as a Stage 2 search.

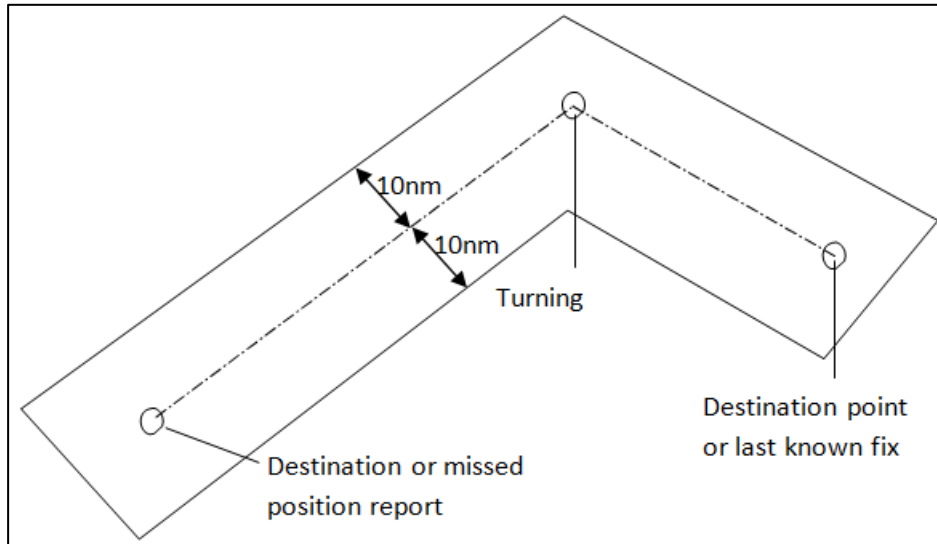

Figure 3-2: Stage 2 Search Area

- 3.5.14 When Stage 1 and Stage 2 search actions fail to locate the target, the probability area should be determined by drawing circles of probability around the last known position, the first missed report position, and any turning points along the planned track. Tangents to the circles then enclose the intervening area. This is referred to as a Stage 3 search and is shown in Figure 3.3. Planning for the Stage 3 search should commence when it is apparent the target cannot be located by the Stage 2 search.

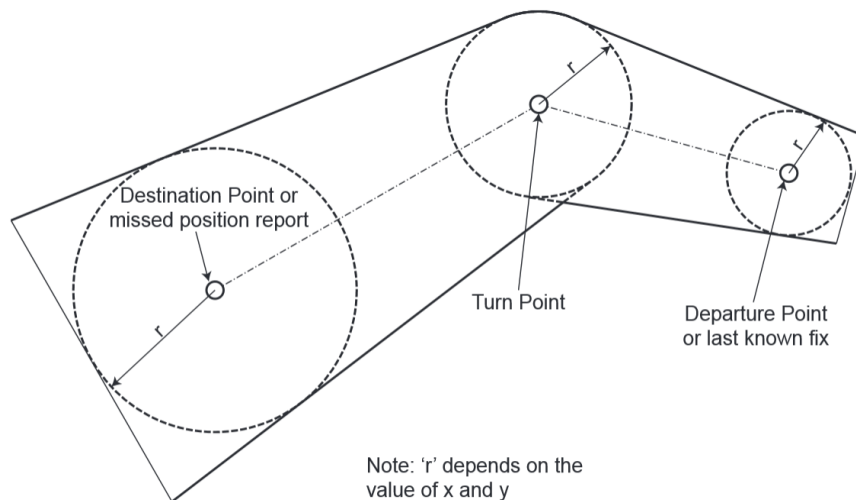

Figure 3-3: Stage 3 Search Area (Mathematically Derived)

- 3.5.15 When a route had been planned to cross the sea, or a large expanse of inland water, or the search involves a marine craft, allowance must be made for movement of survivors in or on the water, brought about by currents and wind.

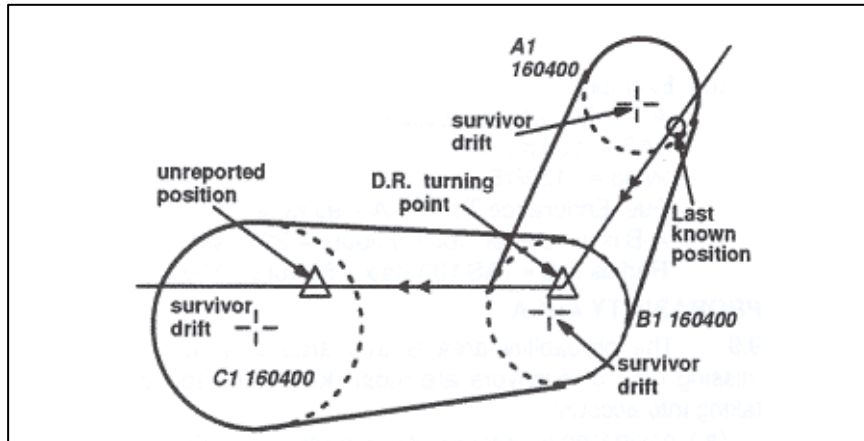

Figure 3-4: Probability Area for an over water Flight or Marine Craft Incident when Track is known

- 3.5.16 The assumption is made that unless otherwise known, or indicated, the pilot/master would follow their planned track as closely as possible. Use of information indicating otherwise would be at the discretion of the SMC.
- 3.5.17 When neither the position nor the intended track of a missing aircraft is known, a probability area must be determined by assessing likely pilot/master decisions in the light of intelligence information received, e.g. the disposition of a township, recent weather conditions; geographical features etc.
- 3.5.18 The examples illustrated in Figure 3-3 and Figure 3-4 are representative of a situation where nothing has been heard from the pilot/master since departure and the pilot/master's route was known. Subsequent intelligence information that is gathered from witnesses and observers near the intended route might allow for the elimination of some route segments.

Calculation of Circles of Probability

- 3.5.19 The Total Probable Error of Position (E) is found from the formula:

$$E = \sqrt{x^2 + y^2 + De^2}$$

where:

x is the probable navigation error of the target (initial position error);

y is the probable navigation error of a search craft (search craft error); and

De is the probable error of the calculated drift of a target in water (total error).

- 3.5.20 In an environment where drift is not available, or does not exist (e.g. coastal or land), the value for de should be zero.

Probable Errors of Position

- 3.5.21 Initial Position Error (x) of the target and Search Asset Position Error (y) are the estimated errors of position based on navigational accuracy of the target and of the search assets. These errors of position for the calculation of (E) can be found in Appendix D-6.
- 3.5.22 X is given the figure of 5nm when it is not known what method, if any, had been used to determine LKP. The SMC can modify this distance based on reliable intelligence and/or information from the pilot/master.
- 3.5.23 Y is given the figure of 1nm as almost all search assets will be making continuous navigation checks using GPS and/or other manual fix methods.

Search Radius (R)

- 3.5.24 This is defined as the radius of a circle, centred at the most probable position of the target at any given time (the Datum), equal in length to the Total Probable Error of Position (E) in nautical miles, increased by a safety factor. For successive searches of the probability area the safety factor is increased progressively.
- 3.5.25 The safety factors applied to the Total Probable Error of Position to obtain a Search Radius (R) are shown in Table 3-2.

Search Effort	Safety Factor
Initial Probability Area	1.1
First Expansion	1.6
Second Expansion	2.0
Third Expansion	2.3
Final Expansion	2.5

Table 3-2: Safety Factors

- 3.5.26 Worksheet 4 (Appendix D7) is available to assist with calculations.
- 3.5.27 JRCC Australia does not use the above safety factors in its programs for computer generating search planning. However, they can be applied to Coastal Search Planning, see Volume 2, Chapter 3.6.

Drift Error for Waterborne Targets

- 3.5.28 Over land, the Datum is the last known position; however when survivors are known or thought to be in or on the water an allowance must be made for movement of the water resulting from the effects of wind and current. The degree of displacement of the Datum from the last known position assumes increasing importance with the passing of time, and MUST be allowed for in search planning. This displacement is a function of:
- The average sea current;
 - The average wind current; and
 - Leeway.
- 3.5.29 The deployment of electronic SAR Datum Buoys should be considered as a means of measuring the movement (direction and speed) of the total water column in which the search target is believed to be immersed. Other sources of information include data held in the JRCC, vessels passing through the search area, and individuals with local knowledge.
- 3.5.30 The direction and speed of these factors is referred to as 'SET'. Contrary to the convention of expressing wind velocity, the direction component indicates the direction of movement. The

speed component is usually quoted in knots. Care must be taken to ensure that the speed unit is both stated, and interpreted, correctly.

- 3.5.31** To determine a value for Drift Error (De) it is necessary to complete a Datum Plot. A Datum Plot provides information both to calculate De and to measure the displacement of the Datum from the Last known Position (LKP) or Splash Point (SP) for the period under consideration. Drift error is derived by the resolution of the three factors (average sea current, average wind current, leeway), by way of vector addition.

Currents

Sea Current

- 3.5.32 Sea current data can be obtained from JRCC Australia, which has access to various sources of information and computer drift modelling software to provide up to date information.
- 3.5.33 Tidal and local geographic features may affect sea currents near the coast. When areas near the coast are to be searched, the water movement for the area should be discussed more fully with local experts.

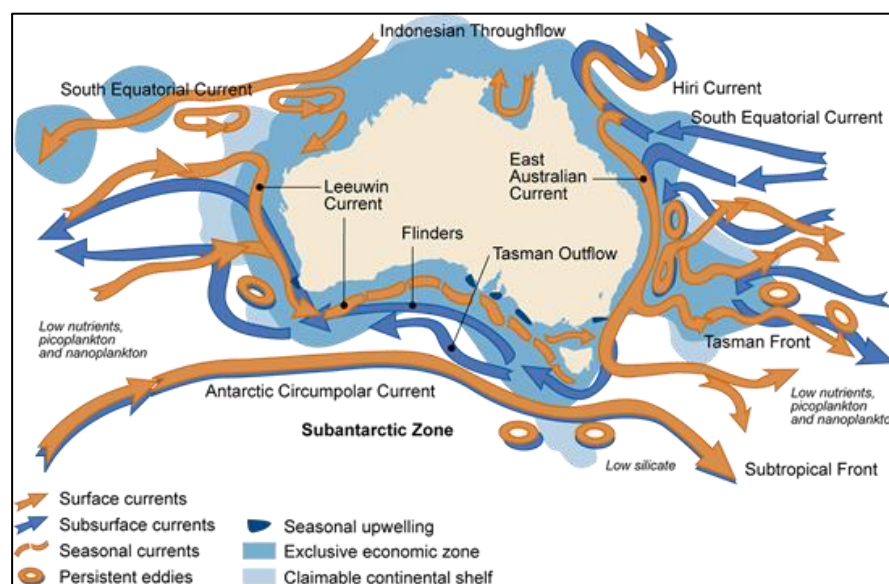

Figure 3-5 Tidal Movements

Tidal Streams

- 3.5.34 Tides are caused by the gravitational pull of the moon and sun, modified by the depth and shape of the sea basin along the coastal areas. Currents in coastal waters are usually affected by tides, changing in predictable velocity as the state of the tide changes. In some locations tidal streams are of the reversing type, abruptly changing direction 180 degrees at about the time of high and low water. In other places the direction will change in small increments so as to create a constant rotary movement. Variations of these tidal effects may also be found.
- 3.5.35 The exact effect of the tide on currents in any specific area may be found by consulting tide tables or local charts. Local knowledge is again of great value in dealing with movements of tidal streams. While the changes in direction of tidal streams have a tendency to nullify the cumulative effect, they must nevertheless be considered in computing drift for the following reasons:
- Often, with reversing streams, the effect in one direction is greater than in the other so that, over a period of time, the resultant effect is more in one direction than in the other; and

- b) Even over short periods of time the flow of tidal streams will cause significant changes in the probable position of a search object.

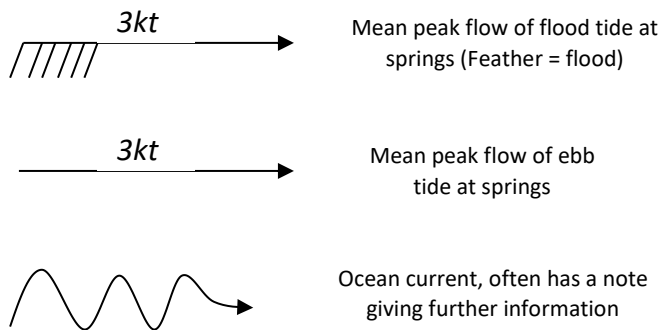

Figure 3-6 Tidal Flow

- 3.5.36 Since most areas affected by tidal streams will be close to landmasses, wind current will usually not be a factor in determining drift. Because of this, drift occurring in in-shore waters over short periods will be more greatly affected by tidal streams than current or leeway. However, if the cumulative effect of tidal streams and coastal currents thrusts the target into areas where sea current takes effect then drift considerations will need to be revised.

River Current

- 3.5.37 River current will affect SAR incidents that occur in offshore areas near river mouths. Tidal streams affect the river current speeds near the mouths of the rivers. In large rivers this affect may be noticed several kilometres upstream from the mouth. Published current tables often give values which are combinations of tidal and river flow effects. These are among areas where reversing streams will be greater in one direction that the other.

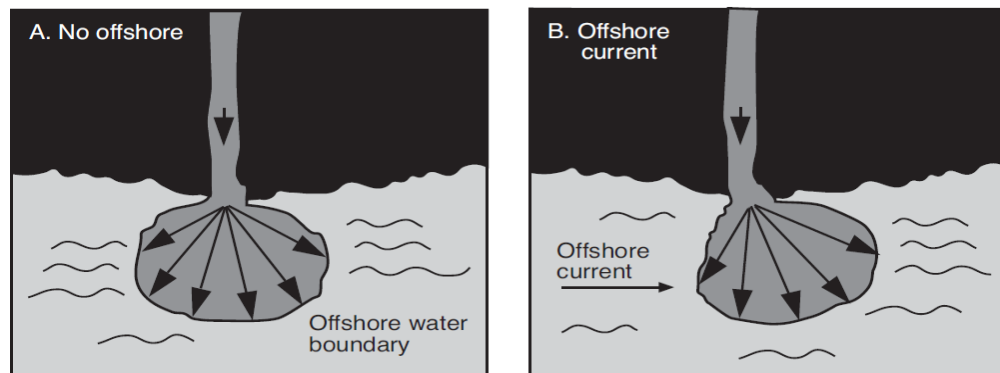

Figure 3-7 River Discharge

- 3.5.38 On the other hand, river current affects both total current and sea current at its mouth. Some major rivers extend their influence quite significantly off shore. Seasonal variations in water volume and velocity should be considered.
- 3.5.39 When estimating river current in the discharge area an assumption that the current direction is a straight line from the river mouth to the discharge boundary and the river current speed decreases linearly from the river mouth to the discharge boundary should be made. The river current speed at the mouth can usually be obtained from local knowledge or by direct observation.
- 3.5.40 If any type of offshore current is present, the SMC should expect that the river discharge will not fan out symmetrically, but will be displaced in the direction of the offshore current.

Longshore Current

- 3.5.41 Longshore currents are caused by incoming swells striking the shore at an angle. Longshore current information must be obtained from direct observation or local knowledge.

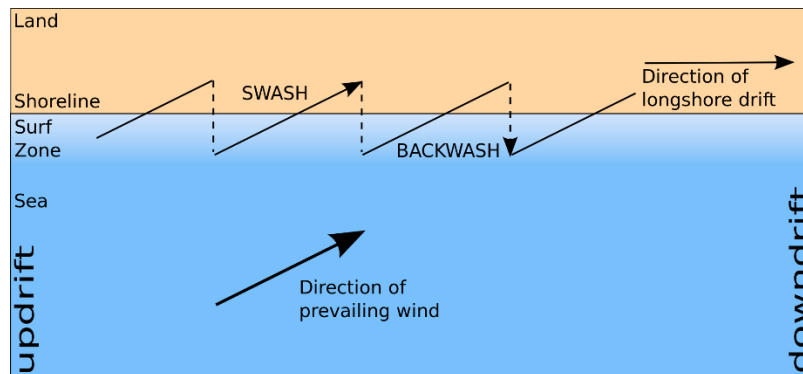

Figure 3-8 Longshore Currents

Swell/Wave Current

- 3.5.42 In calm conditions, swells and waves may affect rafts and other small marine search targets. The effect is similar to leeway in that the raft is being moved through the water. However swell/wave current speed is so small, under 0.1 knot, that the drift force is usually ignored in determining general search areas. It is useful however for determining probable direction of target movement in some cases.

Surf Current

- 3.5.43 Surf current is only considered for incidents occurring in coastal surf areas. It is more of a rescue or salvage factor than a search planning factor. Surf currents will move a drifting object after it enters the surf zone. If no longshore current is present, the surf current will move the object towards the shore perpendicular to the line of breakers. If a long shore current is present, the object will be displaced in the direction of the long shore current.

Rip Current

- 3.5.44 Rip current is a special type of surf current. It is a narrow band of current flowing seaward through the surf line as a result of the long shore current building up a large volume of water along the beach line, and then bursting through the incoming surf on its way back to sea. Rip currents are only a few metres wide through the surf line, but they fan out and slow down when in smoother water. Rip currents occur when longshore currents are present, and in places where some form of bottom trough, bottom rise or shoreline feature assists in deflecting the long shore current build up in a seaward direction.

Local Wind Current

- 3.5.45 Local wind current is the current generated by wind acting on the surface of the water. The current changes with variations of the wind pattern.
- 3.5.46 Near the coast, wind current can be affected by various factors and consideration should be given to omitting the wind current vector from search areas close to the coast. Offshore, consideration should also be given to omitting the wind current vector, if it is considered to be an area of consistent winds. The velocity of a wind current is calculated from:
- Wind data for the 48 hours preceding splash time;
 - Actual and forecast winds between splash time and Datum time; and
 - The application of coefficients taken from tables held in RCCs.

- 3.5.47 Wind current is calculated for 6-hour periods, the periods being coincident with the meteorological synoptic periods. The current for any given synoptic period is the cumulative effect of the wind in the area for the 48 hours prior to the end of the synoptic period being considered. The direction and speed coefficients obtained from the tables allow for the effect of Coriolis, and the reversal of wind direction, to express the result as 'SET'.

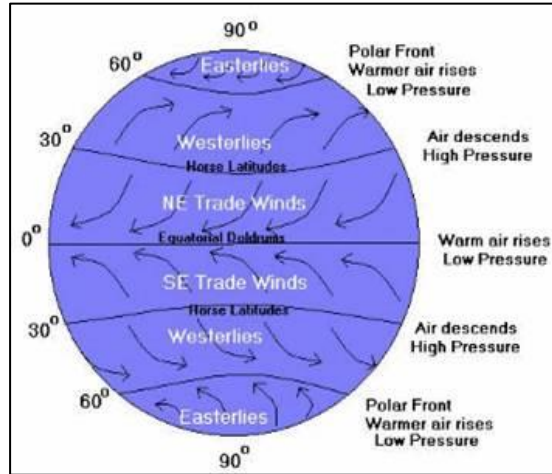

Figure 3-9 Wind Direction and Speed

Leeway

- 3.5.48 Leeway is the movement of a search object caused by it being pushed through the water by local winds blowing against its exposed surfaces. A boat, raft or any other type of marine craft has a certain proportion of its hull and superstructure exposed above the surface of the water at all times. This exposed area is blown against by local winds, which in turn have the effect of pushing the marine craft through the water. The more surface area the wind has to blow against, the greater will be the wind's effect on drift. If the silhouette of a boat were projected onto a flat plane, which was perpendicular to the wind direction, the area enclosed by the silhouette would be called the exposed flat-plane area. As the boat's heading changes relative to the wind, its flat-plane area also changes, usually becoming least when the boat is heading directly into the wind or downwind.
- 3.5.49 The pushing force of the wind is countered by the water drag on the underwater hull. The drag varies with the volume, shape, depth and orientation of the underwater hull. When a marine craft is parallel to the wind direction the least amount of underwater drag will exist since the craft will be pushed through the water in the direction its hull is designed to move. Almost the same conditions exist when the boat is pointed directly into the wind and is being pushed backwards through the water longitudinally. When the boat's heading is perpendicular to the local wind, however, the greatest amount of underwater drag will exist since the boat must now be pushed sideways through the water. Between these extremes the amount of underwater drag will vary depending on the heading of the boat.

Divergence

- 3.5.50 When a search object first begins to drift, the wind will push the object in a downwind direction. As the search object continues to drift, the wind will cause the search object to deflect (or diverge) to either the left or to the right of the downwind direction. The amount of divergence is dependent upon the shape of the exposed flat-plane area of the search object. Divergence is caused by the lack of symmetry of the drift object.

Calculating Leeway

- 3.5.51 A search object's leeway speed is measured as a percentage of the of the wind speed. The Multiplier value listed in the Taxonomy (Appendix D-5:1 & D-5:2) provides the leeway speed

percentage. Because of drag factors, type of object and other environmental effects the wind does not push the target at its full power, and these tables have been calculated to determine at what strength the wind does move an object. In some cases, it is necessary to add or subtract a Modifier to further refine the search object's leeway speed.

3.5.52 The formula to determine leeway speed is:

Leeway Speed (knots) = [Multiplier x Wind Speed (knots)] ± Modifier

Note: By international agreement, wind direction is reported in most places based on the direction the wind is blowing from. For search planning we are interested in the direction the wind is blowing to. When using downwind leeway, the leeway direction is equal to the reciprocal of the wind direction (Wind direction + or – 180°).

3.5.53 The leeway for a person in the water with a wind speed of 20kt would be:

3.5.54 $Lw = [(0.011 \times 20) + 0.07]$

3.5.55 $Lw = [0.22 + 0.07]$

3.5.56 $Lw = 0.29kt$

3.5.57 When directional uncertainty applies, the divergence angle is both added and subtracted to the downwind direction to account for the search object's divergence to the left or right of the downwind direction. Thus, the formula to determine the direction of the divergence is:

Wind Direction +/- 180° = Downwind Direction

Downwind Direction + Divergence Angle = Angle to right of Downwind Direction

Downwind Direction – Divergence Angle = Angle to left of Downwind Direction

The following example illustrates how the Taxonomy is used to determine directional uncertainty leeway. Refer to the Leeway Taxonomy to obtain the appropriate multiplier, modifier, and divergence angle for specific target types.

A search is being conducted for a missing scuba diver. The winds are blowing from 270° True at 15 knots.

Leeway Speed = Multiplier (Table I-1 or I-2) x Wind Speed (knots) + Modifier

Leeway Speed = (0.007 x 15 knots) + 0.08

Leeway Speed = 0.185 knots

Leeway Drift distance (NM) = Leeway Speed (knots) x hours of drift

Vector length (NM) @ Divergence Right (270° - 180°) + 30° = 120° T

Vector length (NM) @ Divergence Left (270° - 180° DEG) – 30° = 060° T

3.5.58 The leeway speed would be multiplied by the number of hours of drift to determine the leeway vector's length. The two leeway vectors would be added to the end of the total water current vector to determine the Right and Left Datum.

3.5.59 The magnitude of leeway speed in relation to wind speed (u) and leeway divergence for persons in water and various types of marine craft can be found in Appendix D-5:1 & D-5:2. The tables have been adapted from Allen and Plourde 1999 Review of Leeway: Field Experiments and Implementation, USCG Research and Development Centre Report No CG-D-08-99. Appendix D-5 also contains the Taxonomy Class Definitions/Descriptions.

Note: Prior to the publication of the data the USCG Research and Development Centre made the decision that the only data published would be data that was based on actual results derived from documented research and observation during controlled field experiments. However it has been recognised that some anomalies exist in the data pertaining to maritime life rafts with no ballast systems. There has been significant time elapse between the initial research done by Hufford and Broida in 1974 and later research by Nash and Willcox in 1991 and it is probable that the make of life raft used for the experiments may no longer be in use. SAR Mission Coordinators

should evaluate the calculated results obtained from using the tables, compare the results with actual known conditions and, if required, adjust leeway values as appropriate.

Plotting Drift

- 3.5.60 Using the vector values determined for average sea current, wind current and leeway it is possible to plot a simple vector diagram and obtain a datum point. However as the leeway data is generally uncertain it is necessary to plot both a left and right drift, and to calculate drift error (De). Whenever possible the owner or operating agency should be contacted to verify the type of life raft carried and its equipment.
- 3.5.61 When plotting on a chart there are a number of standard conventions to identify each of the vectors:

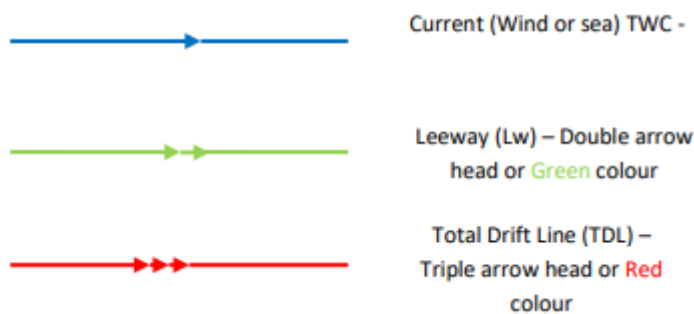

Figure 3-10 Wind Direction and Speed

- 3.5.62 Any change to surface wind conditions has an immediate effect on a craft's leeway, and a recalculation of vectors is required.

Datum Plot

- 3.5.63 The bearing and distance of a Datum from its associated Last known position is found by combining four vectors as shown in Figure 3-11:
- The sea current;
 - The wind current; and
 - Two leeway vectors, one each for left and right divergence.

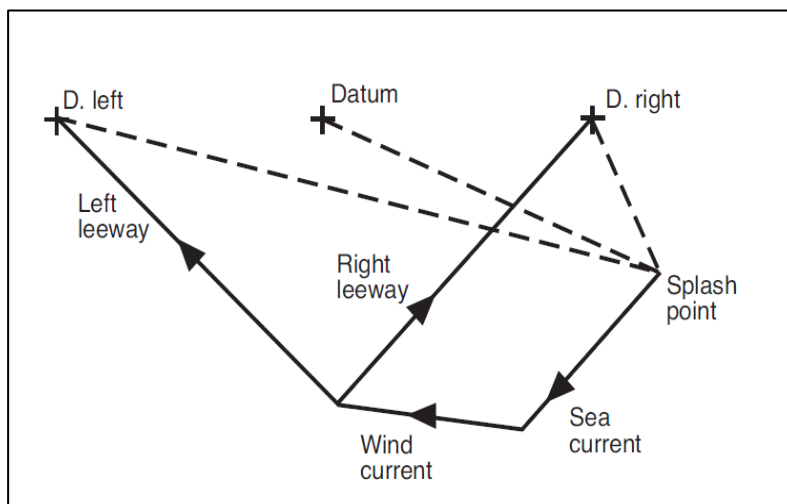

Figure 3-11 Datum Plot

- 3.5.64 The value of the vectors may change with time; therefore it is necessary to calculate a mean value for each vector for the period between splash time and datum time. All calculations are related to meteorological synoptic periods, or part thereof. The objective being to calculate the

movement attributable to each factor during the period under consideration, with a vector summation for the whole period and then to combine the individual effects to establish a most probable position for the target. When the most probable position has been established, an allowance is made for possible errors, which is then combined with the navigation error allowances in the Total Probable Error (E) of Position formula.

- 3.5.65 A Datum Plot should be drawn on the appropriate Chart. To construct the plot, draw the sea current vector from the last known position, add the wind current vector, and then from the end of the wind current vector draw the two leeway vectors. Although not quite correct mathematically, the mid-point between the ends of the leeway vectors may be taken as the Datum.

Drift Error (De)

- 3.5.66 Drift Error (De) is the radius of a circle of probability around the Datum. The circle is externally tangential to two circles of drift error probability drawn around the end of each leeway vector. Generally, the radius of each circle is equal to 12.5% of the distance from the Last Known Position (LKP) or Splash Point (SP) to the end of the appropriate leeway vector. The value of De, therefore, is the sum of the radii of the two leeway probability circles and the distance between the ends of the leeway vector [Distance Left-Right (LR)] divided by two, i.e.

$$D_e = \frac{d_e (L) + d_e (R) + \text{Distance LR}}{2}$$

- 3.5.67

- 3.5.68 However, if the search planner lacks confidence in the data being used to establish drift, a value between 12.5% (1/8) and 33% (1/3) may be used. The less confidence the search planner has in the data, the larger the value used to estimate drift error.

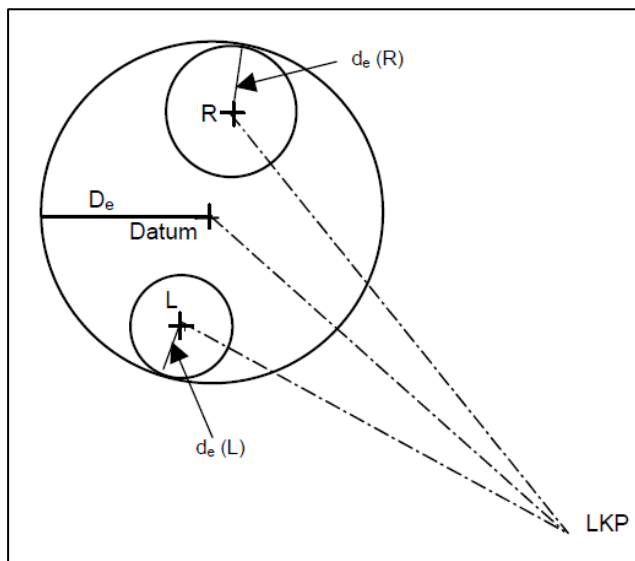

Figure 3-12 Plotting Drift Error

Search Area Based on Non-Moving Datum

- 3.5.69 For a typical last report/missed report situation, where the track between positions is a straight line, the probability area may be modified as in Figure 3-13 to form a trapezium. The area of the trapezium may be found from the formula:

$$A = \frac{L(D + d)}{2}$$

Where L is the distance between datum A and datum B plus the two radii of the circles of probability, and D and d are the measured distances across the ends of the trapezium. It will be readily apparent that this modification will result in a larger area than the original probability area. An estimate of the excess area can be made and taken into account in planning calculations necessary.

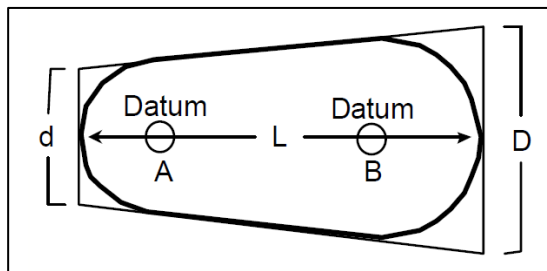

Figure 3-13 Search Area (Non Moving Datum)

Search Based on Moving Datum

- 3.5.70 To calculate the area of an irregularly shaped probability or search area, it will be necessary to sub-divide the area into squares, rectangles or triangles, calculate the size of the smaller area, and sum the results. Use may be made of a surveyor's grid to determine the size of the irregularly shaped areas. In a maritime situation the datum point is moving and areas will move on the chart as depicted in Figure 3-14.

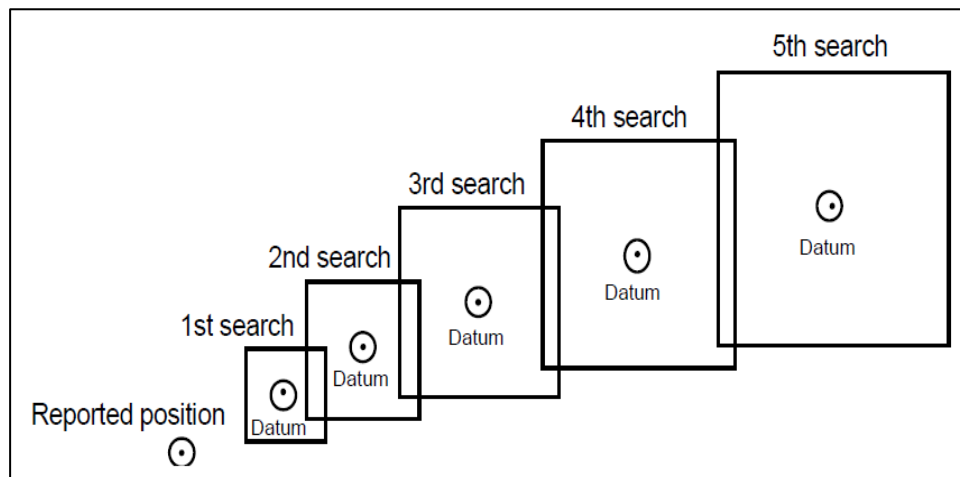

Figure 3-14 Search Areas (Moving Datum Point)

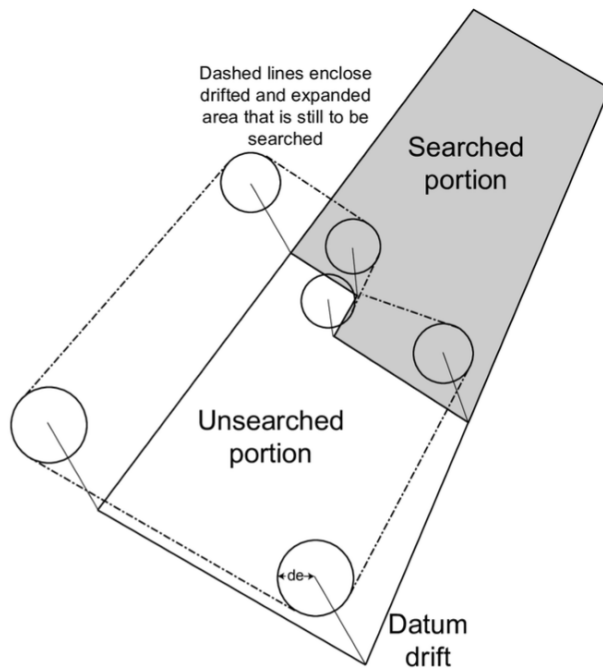

Figure 3-15 Area being Searched at Significantly Different Times

- 3.5.71 It may be necessary to redefine a search area, which is either an unsearched portion of an area, or one derived from intelligence information but located wholly, or partly, over water. In such cases one, or more points on the boundary of the area should be selected, which may then be treated in the same way as any other last known position from which a Datum may be determined.

That is, drift vectors and drift error should be applied to them to give new boundary positions that will compensate for drift effect over the intervening period. The area may then be reconstructed relative to these Data and expanded in proportion to the Search Radii. In doing this it is necessary to draw circles of probability around the Data with Radii equal to "de" and joined by tangents.

- 3.5.72 The appropriate safety factor will have been included in the calculations to determine the original area (see Figure 3-15).

Labelling the Datum

- 3.5.73 During an extended over water search involving several Datum Points it may be necessary to calculate a series of Data. To avoid confusion when referring to Data, a standard system shall be used. The Datum referring to the distress position or last known position shall be identified as 'A', with subsequent positions along a path identified in alphabetical order. Data referring to a particular Datum Point shall be numbered consecutively, and in addition, shall be annotated with a date/time group when depicted on a chart as shown in Figure 3-16.

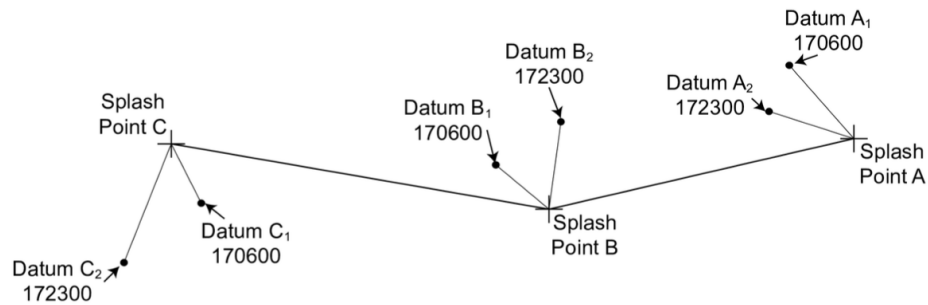

Figure 3-16 Labelling of Data

Modification of the Probability Area

- 3.5.74 Modification of a calculated probability area may be suggested from an assessment of intelligence information received in the RCC, limitations imposed by search asset availability or for other reasons.
- 3.5.75 It should always be understood that SAR calculations are intended to be a guide to search planning, and may be modified to suit any particular situation as suggested by the accumulated SAR experience within the RCC.
- 3.5.76 Any member of the RCC team who considers that a modification would be to advantage shall make the SMC aware of the suggestion. When offering such suggestions, every attempt should be made to present viable alternatives, together with a summary of the advantages, and disadvantages of each. The authority to make any such modification rests solely with the SMC.

Modification Suggested by Intelligence Information

- 3.5.77 During the course of a SAR action, reports and information may be received from a variety of sources claiming that the target had been seen or heard. Detailed analysis of these reports, and comparison with data about known flights, may lead the SMC to delineate a modified, or totally different, search area. Discussion with owners or operators of a target may bring forth information concerning the course of action that would be followed in particular circumstances. Similar information may be gathered from relatives, friends and colleagues.

Modification Resulting from a Shortage of Search Aircraft

- 3.5.78 When it is not possible to search the whole of the probability area in the course of a single sortie by each available aircraft, a number of factors may be changed to facilitate modification of the area. For example: track spacing, aircraft speed, search height or the size of the probability area. After consideration of these factors, the SMC will make a decision which section of a probability area should be searched first.

-
- 3.5.79 Worksheets 2 (Maritime) and 3 (Land) have been developed to assist in determining the extent of the probability area that can be searched with available resources. It is designed to present the SMC with a statement in numerical terms of:
- The desirable intensity of the search, that is, the optimum coverage factor;
 - The amount of area which can be searched at the desired coverage factor, and, if this is less than the area described; and
 - The quality of search that can be obtained by covering the whole area with the search aircraft available.

Modification of Areas Incorporating De and Increased Safety Factors

- 3.5.80 Care must be taken not to waste search effort on the section of the probability area that encompasses land areas as a result of incorporating allowance for water movement. To avoid this, reference should be made to the fundamental probability area, calculated by using only the 'x' factor. A search of any coastline included in a drifted area should always be made.
- 3.5.81 Similar consideration should be made when an area that is predominantly over land is expanded, and subsequently includes an area of water. This situation is not so simple and clear cut, and may require reference to intelligence information to justify the inclusion, or exclusion, of the over-water area. Should it be decided to search the over-water part of an expanded probability area, movement of the now included over-water part must be taken into account for the period between Splash Time and Datum Time.

Modification for the Allocation of Areas to Search Assets Other than Aircraft

- 3.5.82 When drawing up a probability area the allowance for search craft navigation is usually that specified for aircraft. When using other types of search assets, i.e. land or marine, it will be advantageous to recalculate the probability area using the appropriate value for 'y'.

Consideration of Possible Courses of Action by the Captain of the Target

- 3.5.83 Through an analysis of intelligence information, or because of the failure to locate a target in the probability area, even after the expansion to the 2.5c safety factor, it may be considered necessary to search other areas or tracks. All decisions of this nature are the responsibility of the SMC. The general guidelines for determination or probability areas should be applied.

3.6 Coastal Search Planning

Search Area

- 3.6.1 A great number of maritime search and rescue incidents occur within 25 NM of the coast, in under 100 metres of water. The coastal search-planning model is to assist with a rapid response and should ideally be used when the report of a target in distress is notified to a SAR authority within six (6) hours of the actual distress situation arising.
- 3.6.2 This section is aimed at simplifying the search planning methods when this situation arises. If time and asset availability allow, the oceanic model should be used. The principles in other sections under search planning should be referred to. If this model is used and overall coordination of the incident is handed to another SAR authority that SAR authority should be made aware of the situation and model used.

- 3.6.3 In most cases, considering the short response time to coastal SAR incidents, if the search asset proceeds to the Splash Point (SP) of the target in distress it will be found. However, the target in distress may not be in sight because of inaccuracies in the initial position reported; inherent errors associated with drift factors; and/or errors in the navigation of the search asset.
- 3.6.4 If the time since the target became distressed is less than four (4) hours and it is not located at the SP draw a 6 NM radius centred at the LKP. Then draw a square search area with the sides tangential to the circle. This will give a search area of 144 NM² (as shown in Figure 3-16).

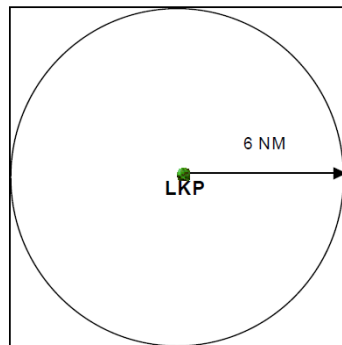

Figure 3-17 Circle of Probability using Coastal Method

- 3.6.5 The purpose of drawing a radius around the datum is to describe the geographical area most likely to contain the search object. The formula uses the Total Probable Error (E), which includes the Initial Position Error (X) of the target and the Navigation Error of the SRA (Y), but does not include Drift Error (De).

$$E = \sqrt{X^2 + Y^2}$$

- 3.6.6 For coastal SAR cases when an SRA arrives on scene and the search object is not seen, a five (5) NM position error for the target and a one (1) NM navigation error for the SRA may be assumed. Using the formula, when X = 5 and Y = 1 then:

$$E = \sqrt{25 + 1}$$

$$E = \sqrt{26}$$

$$E = 5.099 \text{ NM}$$

- 3.6.7 Applying the safety factor for the first search ($f_s = 1.1$), then:

$$\text{Radius} = (E)(f_s)$$

$$\text{Radius} = (5.099)(1.1)$$

$$\text{Radius} = 5.6 \text{ NM.}$$

This is rounded up to six (6) NM.

- 3.6.8 If the time is greater than four (4) hours but less than six (6) hours, and/or the drift, based on local knowledge and/or on scene conditions, is considered to be significant, the search objects drift should be established, and the six (6) NM radius applied to the drift datum position.
- 3.6.9 In coastal SAR, the initial datum is determined by calculating drift using the object's LKP and the effects of water current and leeway speed and direction without considering leeway divergence (leeway direction is considered to be directly downwind). Time of datum must take the underway transit time for the SRA into consideration Figure 3-18.

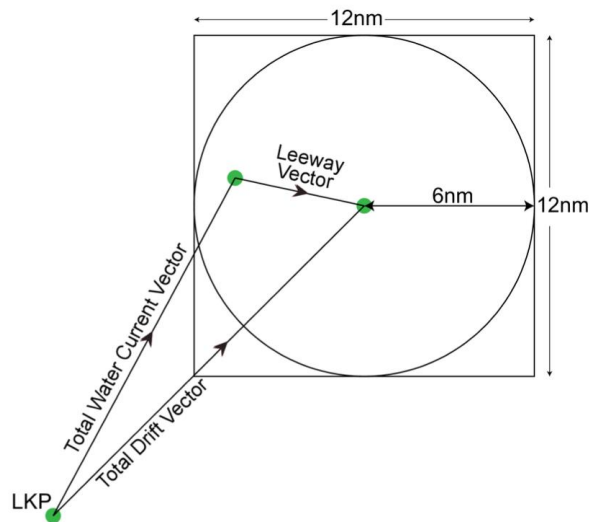

Figure 3-18 Circle of Probability Using Coastal Method and Allowing for Drift

- 3.6.10 If the target in distress reports a position in shallow water there is always the possibility that the vessel may attempt to anchor. Therefore, particular attention should be paid to the situation when the LKP or SP is outside the established search area. In many cases, it should be possible to search along the drift line from the LKP or SP to the datum during the initial search. However, it may be necessary to search the drift line after the search area has been completed.
- 3.6.11 If the time of the incident is uncertain, calculate a datum for the shortest possible time the vessel could be adrift, and calculate a second datum for the longest possible time the vessel could be adrift. Draw a circle of six (6) NM around each datum point and then enclose the circles in a rectangle (Figure 3-19). To determine the size of the area, multiply the length in miles by the width in miles.

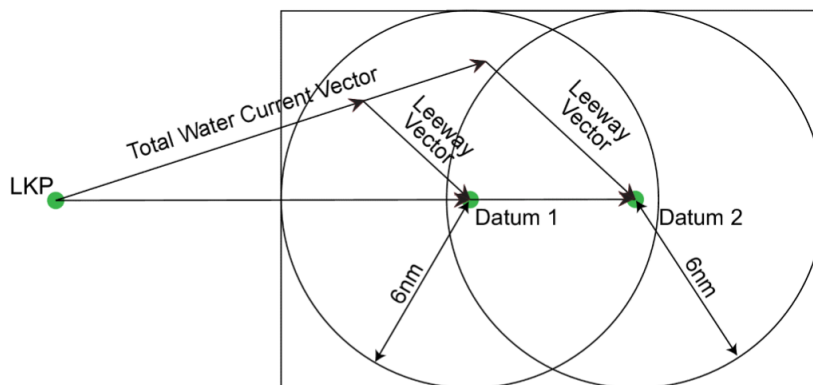

Figure 3-19 Circles of Probability when Time Uncertain

Position Uncertainty

- 3.6.12 If the position of the target in distress is in question, calculate a datum for each position (LKP 1 and LKP 2) and draw a six (6) NM circle around each and enclose the circles (Figure 3 19). The search Datum can be assumed as a point midway between the two individually calculated Data. If extreme distances separate the positions in doubt, (More than 12nm), consideration should be given to treating them as separate vessel adrift incidents (Figure 3 21).

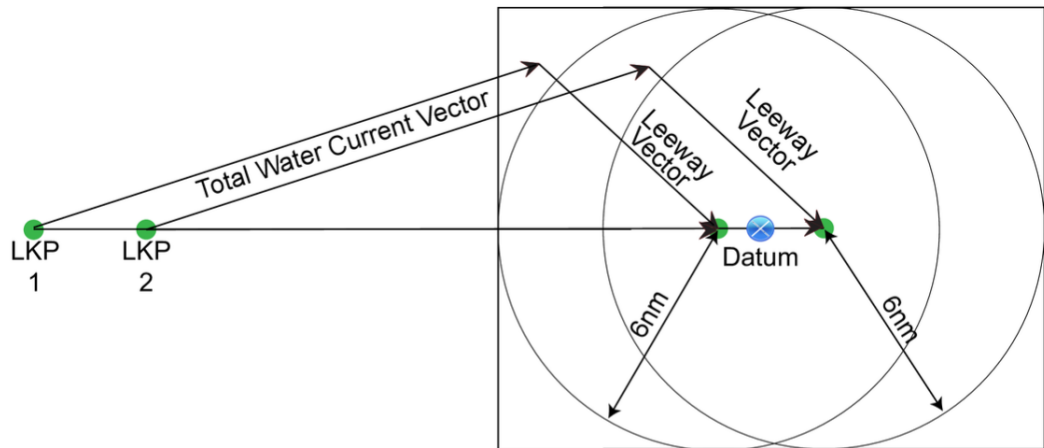

Figure 3-20 Circles of Probability when Time Uncertain

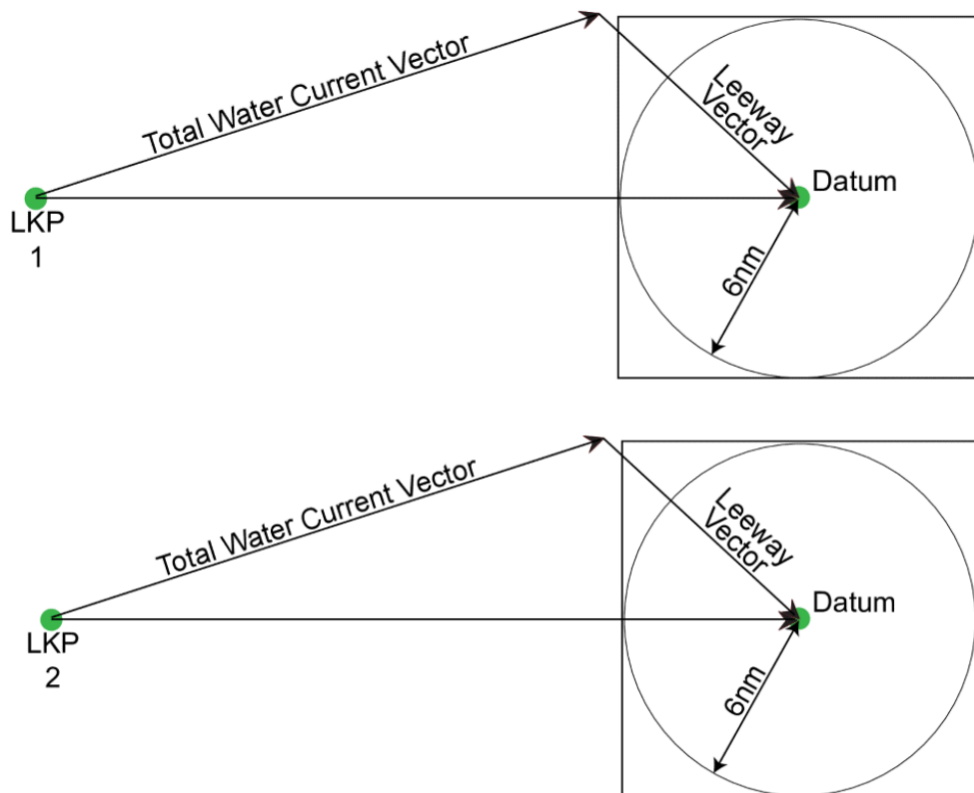

Figure 3-21 Circles of Probability when position Uncertain and Extreme Distances Separate Positions

Track Line Overdue Incident

- 3.6.13 If a target in distress is overdue along a track line, determine a datum near the beginning of the track, another near the end of track and one at each turning point. The datum line is the line

joining each datum. Draw a six (6) NM circle around each datum and enclose the circles in rectangles with sides drawn tangentially to the datum circles (Figure 3-22).

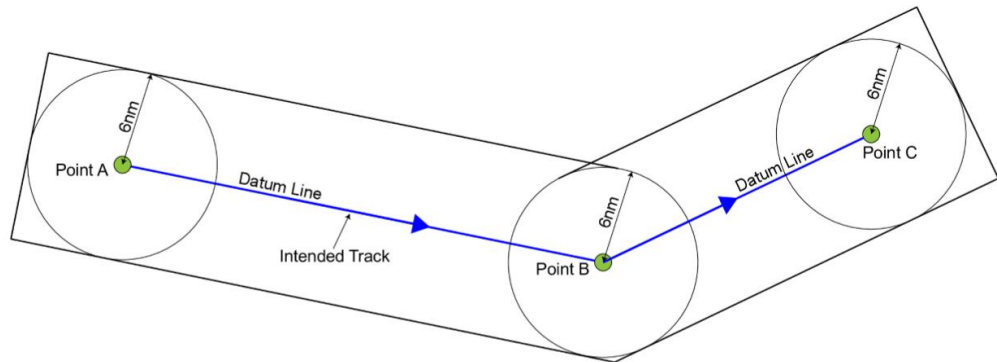

Figure 3-22 Track Line Overdue Incident ≤ 4 Hours

- 3.6.14 If time to datum is more than four (4) hours allow for drift of starting, ending and turning points as seen in Figure 3-23.

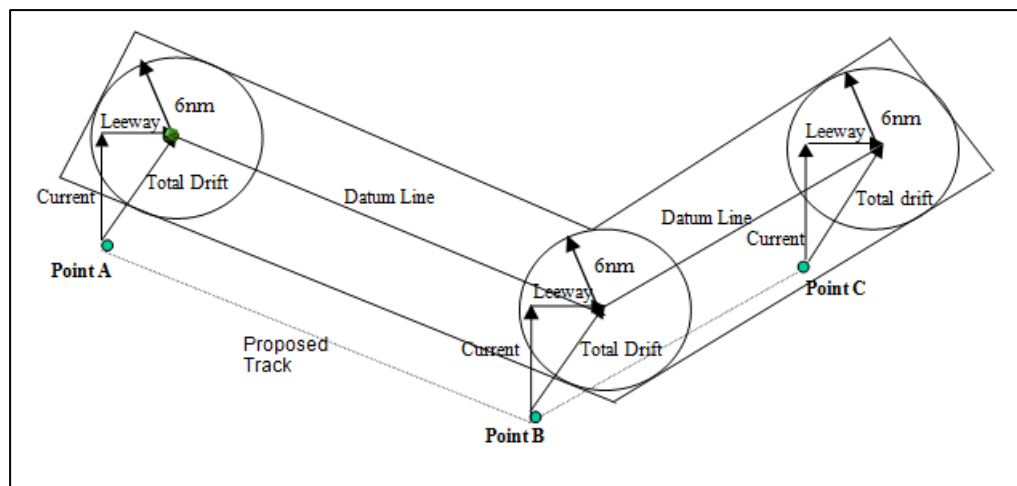

Figure 3-23 Track Line Overdue Incident > 4 Hours

Recomputed Datum

- 3.6.15 As a general rule in coastal situations, the datum is recomputed every two (2) to four (4) hours.
- 3.6.16 When re-computing a datum that was initially established using the coastal model the drift error (de) of the target must be calculated. As with the case in oceanic search planning, drift error rate estimates usually fall between 12.5% (1/8) and 33% (1/3) of the total distance drifted. The search planner, depending on the confidence or lack thereof in the relevant drift data, would use a value between 12.5% (1/8) and 33% (1/3), increasing in size as the confidence in the data decreases. The higher the confidence in the data the smaller the value used to estimate drift error. The search planner may also use values outside this range.
- 3.6.17 In addition, the total drift error for two or more successive drift updates is the sum of all the individual drift errors up to that point therefore, drift error always increases with the passage of time.
- 3.6.18 In this model, the distance from datum1 to the recomputed datum2 is measured. The de of the position is established, generally using 1/8th of the drifted distance as error, and then adding this distance to the 6 NM assumed error (E) used to establish the initial search area.

Example

3.6.19 The target is drifted from its LKP or SP to datum1 and an E = 6 NM is plotted. The target’s drift is recalculated sometime later and its drift is established as eight (8) NM from datum1. Using 1/8th of the targets drift as error, one (1) NM is added to the initial six (6) NM error used for the first datum. Therefore the error used for datum2 is 6 NM + 1 NM = 7 NM. See Figure 3-23 below.

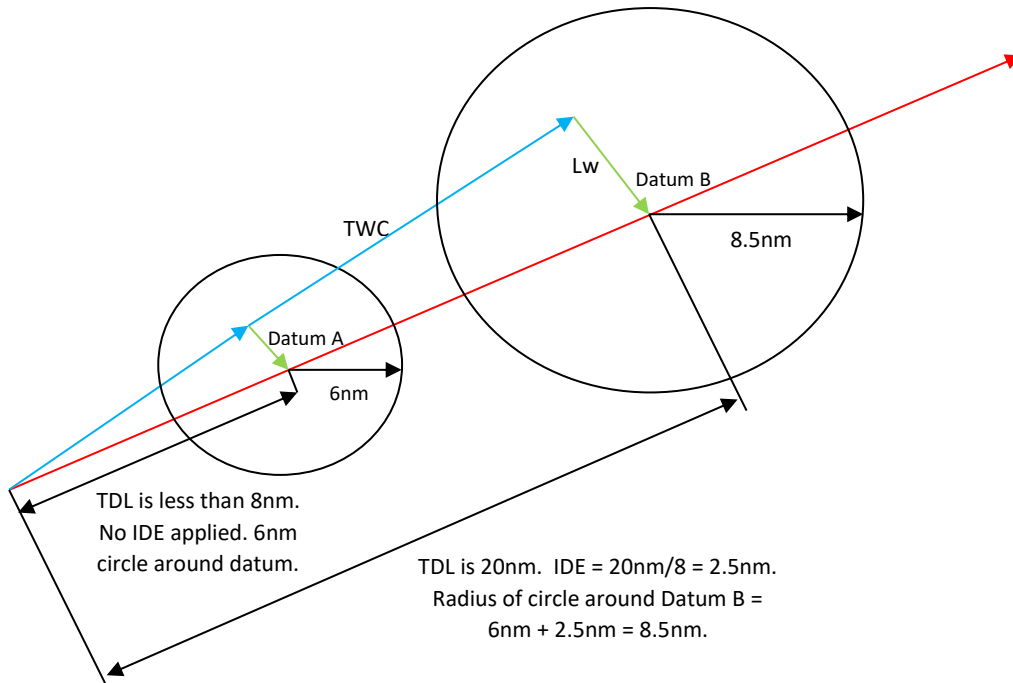

Figure 3-24 Re-computing Datum

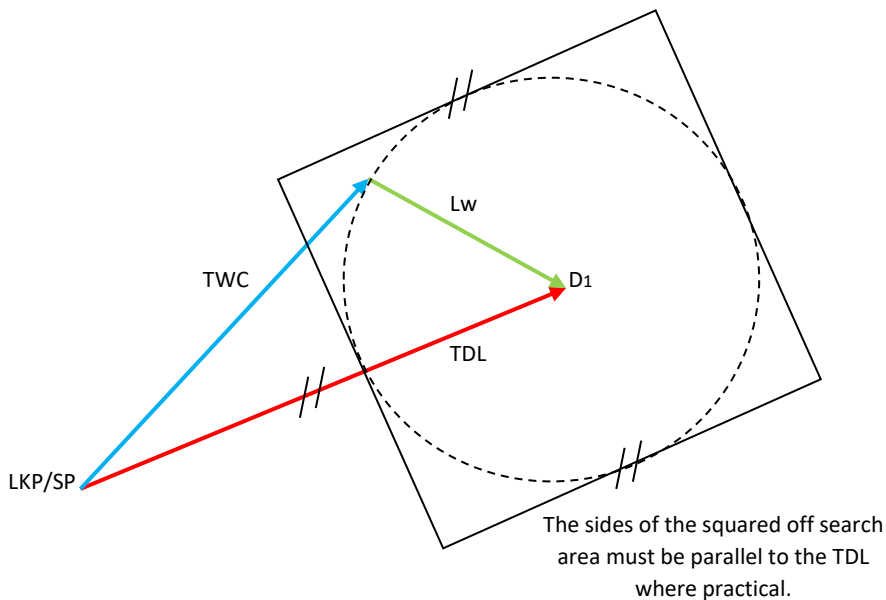
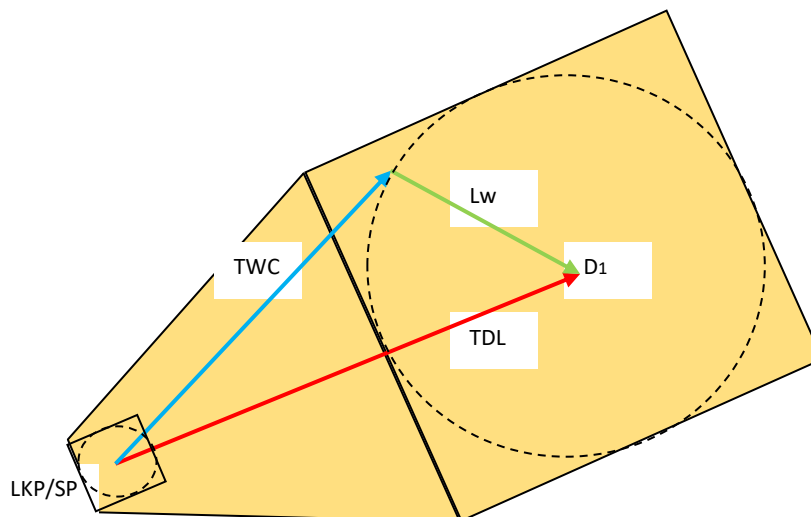

Figure 3-25 Boxed off search area



The SMC should consider searching the area between the LKP/SP and the Datum Point (D_1) if the possibility exists that the target could anchor or if there are any fixed structures such as offshore platforms, buoys, or beacons from which a vessel could be attached or a person in the water could gain support.

3.6.20

Figure 3-26 Total search area

Track Spacing

3.6.21 For the coastal search model, the following standard track spacing is recommended on search objects less than 30 feet high.

Good Search Conditions

3.6.22 In conditions where the wind speed is less than 15 knots and/or visibility is greater than three (3) NM (5km), use a track spacing of up to three (3) NM by day or night but reduce the separation depending on the size of the search target. After dark, the effect of the search light should be considered..

Poor Search Conditions

3.6.23 Where winds are greater than 15 knots and /or visibility is less than three (3) NM but greater than one (1) NM (2-5km), a track spacing of 1 NM should be considered by day or night but reduced depending on the size of the search target. After dark, the effect of the search light should be considered.

Person in Water

3.6.24 When searching for a person in the water, it should be assumed that the person is not wearing a flotation device and will therefore be more difficult to detect. For good search conditions a track spacing of a 0.25 nautical mile should be considered. For poor search conditions, the track spacing should be reduced as appropriate, taking into account the visibility and the navigational and operational capabilities of the search asset.

3.6.25 Note that the track spacing suggested is given as a guide only. The track spacing used in any one (1) search will be decided by the SMC in consultation with the OSC taking into consideration all the available information at the time.

General considerations

- 3.6.26 As outlined earlier, the coastal SAR planning model described here is used to facilitate ease of determining a search area and a rapid deployment of search assets into a search area.
- 3.6.27 Although it is ideally used when the response is mounted less than six (6) hours from the time of distress the principles can also be applied for up to 24 hours after this time by drifting the datum as described in the section headed Recomputed Datum. This provides the SMC with a tool to rapidly determine a search area.
- 3.6.28 The oceanic model incorporating leeway divergence and solving for total probable error should be used for all situations in excess of 24 hours or when time and asset availability allows.

3.7 Land Search Planning

Overview

- 3.7.1 Land SAR is the operational coordination and management of a search and rescue response for the following situations:
 - a) A person/vehicle/vessel or aircraft reported missing in a land environment.
 - b) A person/vehicle/vessel or aircraft reported overdue as a result of either scheduled contact time or a planned excursion in a land environment.
 - c) A request from another SAR authority to assist in a land based SAR incident
 - d) Evidentiary and crime searching in a land based environment
- 3.7.2 It is important for the SMC to make an assessment of the facts of the situation relating to the missing person, as soon as possible after receiving significant information. These assessments may prevent any of the following errors being made:
 - a) A search operation too slowly implemented due to a poor appreciation of the missing person's life and death situation.
 - b) A search operation which is terminated prematurely because it is falsely assumed that the missing person could not have survived.
 - c) A search operation which is conducted in too small or large a search area because of a lack of knowledge related to the missing person's mobility.
- 3.7.3 While there will be many similarities in individual searches, each search will present its own peculiar problems.
- 3.7.4 Unless each search is considered in detail and likely problems identified, the result could be:
 - a) Loss of life
 - b) An ineffective search
 - c) An aggravation of the situation
 - d) Bad publicity
 - e) A loss of community credibility for the SAR Authority and/or searchers
 - f) A loss of organisation or individual morale
 - g) Any combination of the above

3.8 Incident Command

- 3.8.1 There are a variety of Incident Command Systems in use in Australia, including ICS, CIMS, AIMS and AIMS II. All of these systems have much in common, including the five principle core functions.

-
- 3.8.2 The five mutually inclusive and interlocking roles are command, planning, operations, intelligence and administration and logistics.
 - 3.8.3 The command role is responsible for the command, control and coordination of the incident, including gaining situational awareness, establishing command and leadership, establishing a Field Search Headquarters (FSH), assign tasks, provide situation reports (sitreps) to senior members and to ensure a log is maintained.
 - 3.8.4 The planning role is responsible for the development of the Search Plan and the Rescue Plan, and also includes conducting ongoing situational awareness.
 - 3.8.5 The operations role is responsible for coordinating activities in accordance with the Search and Rescue plans. This also includes briefing personnel, coordinating external agencies and preserving the scene in the case of an evidentiary search.
 - 3.8.6 The intelligence role is responsible for collection, collation, evaluation and dissemination of information relating to the SAR incident. This includes gathering information on topography, weather, missing person/vehicle/aircraft or vessel, previous searches in the area, maps of the area and to ensure the security of incident documentation.
 - 3.8.7 The final role, administration and logistics, is responsible for acquiring, recording and tracking of resources used for the SAR and includes identifying all personnel involved, provision of equipment, obtaining specialist support, arranging transport, provision of food and welfare and medical assistance.
 - 3.8.8 Initially the SMC will need to undertake all five roles until further assistance arrives.

3.9 Situational Awareness

- 3.9.1 Before any SAR incident can be prosecuted the SMC must have situational awareness in relation to the incident. Without this the SMC is blindfolded and will be making decisions that are not based on the actualities of the incident. If the SMC is in unfamiliar terrain then any time spent gaining situational awareness, either through a drive around, a fly over or at the least, a study of a topographical map, is never wasted.
- 3.9.2 Definition: The accepted definition of situational awareness is 'The perception of the elements in the environment within a volume of space and time, the comprehension of their meaning and the projection of their status in the near future.'
- 3.9.3 The first part is recognising all the small components that make up the SAR scenario at that particular time and location. As the scenario develops these small components will change, making them only valid for a short period. These small components may include:
 - a) Weather
 - b) Missing person/vehicle/vessel or aircraft
 - c) Terrain/topography
 - d) Incident location
 - e) Daylight/darkness
 - f) Resources available
 - g) Lead times for resources
 - h) Coordination activities

-
- 3.9.4 The second part is understanding what each of these small components means. Examples of this are as follows:
- a) Weather – What impact will the immediate weather have on the search, the searchers, the missing person/vehicle/vessel or aircraft, visibility, specialised clothing and food requirements?
 - b) Missing person/vehicle/vessel or aircraft – What is the description of the target, changes that may occur as a result of the incident causes (Crash, overturned, fire), difficulty of finding the target, location of the target, safety and/or danger features.
 - c) Terrain/topography – how will this impact on the search, searchers, search area determination, person/vehicle/vessel or aircraft, resource requirements, time, funnel points, barriers.
 - d) Incident location – transport to and from scene, travel from FSH to search areas, lead time, specialist transport/search techniques, resource availability.
 - e) Daylight/darkness – search time available, travel time, search visibility
 - f) Resources available – type and number, suitability, availability, lead time, specialist resources.
 - g) Lead times for resources – time to scene, time on scene, resupply
 - h) Coordination activities – availability of trained coordination staff, incident command system, availability of maps, electronic aids, printers, communication systems.
- 3.9.5 The last part is how each of these components will affect the immediate future of the SAR incident. Some of these components will not change allowing for easily identified future planning, whereas other will change from hour to hour, with the associated difficulty in predicting how to use them or if they are usable at all.

3.10 Conducting an Appreciation

- 3.10.6 Before any search is conducted, the situation must be examined to determine:
- a) What has/or may have happened;
 - b) What has/or needs to be done;
 - c) What problems might be present or occur as the search develops;
 - d) How these problems might be overcome; and
 - e) How the operation is going to be conducted.
- 3.10.7 This process is called ‘conducting an appreciation’ and can range from ‘a quick think’ of a few seconds to a deliberate consideration taking hours of work.

Definition

- 3.10.8 An appreciation is an examination of all factors present in any situation which, in turn, will suggest possible courses of action.

Sequence

- 3.10.9 No matter what the situation, the sequence of conducting an appreciation for any search should always be the same. This will ensure no point is overlooked.

Phases

- 3.10.10 The phases in conducting an appreciation are:
- a) Determine the aim;

- b) Examine the relevant factors;
- c) Determine the courses open;
- d) Select the best course of action; and
- e) Formulate the plan.

Aim

3.10.11 By correctly defining the aim, the problem will be identified and what is to be achieved will be stated. The aim must be:

- a) Clear;
- b) Concise; and
- c) Achievable.

3.10.12 The aim should be one short, concise sentence and should start with a positive action statement. The standard aim for a land search is 'To locate the missing person and remove them to a place of safety'. On the face of it this appears to be an aim with two parts. In reality it is a single aim in the same way search and rescue is a single action. Locating the target person is not the end of the incident, the SAR does not conclude until the missing person is in a place of safety. This also applies to deceased persons as the recovery of a body is paramount to the SAR. There will be instances where the missing person is never located, therefore the aim will never be achieved.

Limitations

3.10.13 Sometimes there may be problems that will place limitations on the aim. If the missing person is a child or has a medical problem requiring urgent attention, the search will have to be an immediate continuous search until found or called off. In a case such as this, the aim will have to be modified to take account of the limitation, e.g. 'To locate the missing person within a specified time'.

Written Statement

3.10.14 The aim should be written down and constantly referred to as the appreciation is developed.

Factors

3.10.15 Factors are pieces of information which can affect the plan and can dictate the urgency of response. Not all factors will be relevant and some will have a greater effect on the plan than others.

Examination

3.10.16 Only a careful examination of each factor will decide which is relevant, and establish the importance of the relevant factors to the plan. In examining each factor, it will be possible to make deductions which may have a bearing on the search. To do this, ask the question 'so what?' of each factor and answer until a logical conclusion is reached.

3.10.17 **Example:** To determine the timetable necessary to enable the Field Search Headquarters to be operational by 0600 hours.

- a) **Factor:** It takes 90 minutes to get the headquarters operational once on site.
So what?
Will have to be on site not later than 0430 hours.
- b) **Factor:** It will take 45 minutes to travel to the headquarters site.
So what?

Will have to depart base area not later than 0345 hours.

- c) **Factor:** It will take 15 minutes to load stores prior to departure from base.

So what?

Loading must commence not later than 0330 hours.

- d) **Factor:** The Equipment Officer will require 30 minutes to prepare and check equipment prior to loading.

So what?

The Equipment Officer is to commence task not later than 0300 hours.

3.10.18 Using this process to examine each factor, it is possible to determine the course of action necessary to achieve the aim.

3.11 Courses Open

3.11.1 The courses open are all the possible solutions to the problem which have been found through an analysis of the factors. Whilst all of them might work, an analysis of each course will show their advantages and disadvantages.

3.11.2 **Example:** In a search for a missing child from the point where the child was last seen:

- a) **Course One** - Using people already there as searchers:

Advantages:

- i) The child may be found quickly.
- ii) May not need to organise other searchers.

Disadvantages:

- i) The people on site are unlikely to have previous search experience which means they will be unable to start without basic instruction in search techniques.
- ii) Instructing these people will take time.
- iii) Because of inexperience, they may become lost or injured.
- iv) They may also destroy clues of value to trained searchers.

- b) **Course Two** - Await the arrival of trained searchers:

Advantages:

- i) They require no training before commencing the search.
- ii) They are less likely to become lost or injured.
- iii) The likelihood of finding clues of value is greater.

Disadvantages:

- i) It will take time to organise the call-out.
- ii) They will take time to travel to the site.

Plan

3.11.3 From the examination of the courses open, it can be determined that while both courses have advantages and disadvantages, it may be more appropriate to await the arrival of trained searchers.

3.11.4 From this selection, a plan to allow for the use of trained searchers can be formulated.

Planning Principles

- 3.11.5 The principles which should be observed when formulating any plan are:
- a) Keep it simple;
 - b) Ensure it relates directly to the aim; and
 - c) Ensure it is based on logical deductions.

Keep it simple

- 3.11.6 The best plans are simple, easy to prepare and are usually flexible enough to adapt. Complicated plans are not only more difficult to prepare, but they may be difficult to change once activated.

Relate to the Aim

- 3.11.7 If the plan does not relate to the aim, the aim will not be achieved and the operation may be a failure.

Logical deductions

- 3.11.8 If the plan is based on logical deductions, the plan will generally work.
- 3.11.9 It is essential that prior to taking any action and committing searchers to an operation, an appreciation is conducted identifying the most appropriate plan for the conduct of the operation. This does not mean that a reflex search cannot be commenced as soon as the need for it arises and if the urgency dictates.

Land Search Planning

- 3.11.10 The wellbeing of survivors is critically dependent on their early location and support. It is vital that as soon as possible after becoming aware of an incident, the SMC quickly implements procedures for a rapid search of the most likely area of distress. In general, the initial SAR response requires ready application of simple procedures to quickly cover the most likely areas of distress. The search area described will be of rudimentary construction, e.g. a circle, square or rectangle depending on the Lost Person Behaviour and other intelligence gathered on the MP. The area will be of sufficient size to cover all reasonable alternative tracks of the MP and will incorporate all areas highlighted by intelligence information. This strategy precedes the more complex calculations that will give rise to a more precise area which, failing the success of the reconnaissance search will form the basis for a formally planned and executed action at a later time. The stage one search may be undertaken in relatively short time and allow ready allocation and briefing of the few necessary resources.
- 3.11.11 All of the basic land search theory concepts are described in this chapter. Practical examples are provided for each concept, showing how it may be applied to the search-planning problem. These examples require only basic mathematic skills and an understanding of the basic probability concepts encountered in everyday life. Although search planning may be perceived to be complex, each step is relatively simple.
- Note:** It is essential when planning commences for search operations that rescue planning is commenced as outlined in Volume 2, Chapter 5. This is to occur as a concurrent action. Rescue planning forms an integral part of the Search Planning.
- 3.11.12 There are three possible places to commence a land search from:
- 3.11.13 LKP: This is the Last Known Position of the target, and relates to when the target was visually seen by a witness. This may be at the start of a bush walk or perhaps in their room at a care facility.

-
- 3.11.14 PLS: This is the Place Last Seen, and is subtly different from LKP. A PLS is often identified during the intelligence phase when witnesses come forward with information on possible sightings of the target. This information should be assessed against time, ability of target to travel to that location and other factors of the incident.
- 3.11.15 IPP: This is an Initial Planning Point and is a location identified by the SMC where the search should commence. An example may be a missing bush walker, their LKP was their bedroom at their dwelling the day before, and the PLS may be the same location. This is not the best location to commence a search unless information suggests the target never left home. If their vehicle was located at the entrance to bush walking area, and their intention was to go bush walking it is logical to commence the search from the vehicle. Even though there was no visual sighting of the target leaving the vehicle it becomes a good Initial Planning Point until further information comes to light.
- 3.11.16 Search planning involves the following steps:
- a) Evaluating the situation, including the results of any previous searching;
 - b) Identifying the Last Known Position (LKP) of the MP and any error associated with that location;
 - c) Estimating the MP's post LKP movements and any associated error of that estimate;
 - d) Using these results to estimate the most probable location or route of the MP and the uncertainty about that location;
 - e) Determining the best way to use the available search assets so the chances of finding the MP are maximized (optimal search effort allocation);
 - f) Defining search sub-areas and search patterns for assignment to specific search assets; and
 - g) Providing a search plan that includes a current description of the situation, search object description(s), specific search responsibilities to search assets, on-scene coordination instructions and search asset reporting requirements.
- 3.11.17 These steps are repeated until either the MP/s' are located or an evaluation of the situation shows that further searching would be futile.

Scenario-based Assessment

- 3.11.18 Scenario-based searching assesses the reasons for the loss of an object or the disappearance of a person and can be used alone or in conjunction with an appreciation. Consideration is given to all factors that may assist or impede the discovery of the missing person or object. A search strategy is developed from this in the eight stage process as described below. This method presents a better alternative to speculative searching as it is based on a full evaluation of all information available. It also allows for the consideration of multiple scenarios and ensures that the most appropriate assets available are used. If more than one scenario emerges, action must be prioritised according to the relevant merits of each scenario and the resources available.
- 3.11.19 The eight stage process, SCENARIO, is a mnemonic designed to ensure that all of the objectives are achieved when searching for any type of object.
- S** Specify person or item sought
 - C** Confirm last location
 - E** Establish circumstances of disappearance
 - N** Note factors influencing discovery
 - A** Analyse possible strategies
 - R** Raise search strategies
 - I** Identify priority search
 - O** Ongoing reassessment

Factors Influencing Discovery

- 3.11.20 It is important to keep the search area contained and free of extraneous distractions such as other members of the public. Family of the target may also have a detrimental effect of the search. Other factors that may hamper discovery are the terrain, weather, resources and the need to preserve clues if the search is running parallel with a criminal inquiry.

Analyse possible land strategies

- 3.11.21 What are the likely scenarios from the above information? What happened for the person to become missing?

Raise land search strategies

- 3.11.22 A search strategy should be planned for the most likely scenario, based on resources available, search areas, containment and possible routes. If one scenario stands out a search should be instigated immediately. Searches of areas and routes must be achievable by the allocated resources within the allotted time.

Identify priority land search area

- 3.11.23 The above information will identify the priority search area. This area may change as further information comes to hand. As resources become available further scenarios can be searched. Where resources are limited, the area of highest priority should be given preference. The decision making process behind this needs to be recorded in the running log.

Ongoing reassessment of land search

- 3.11.24 The whole process must be continually reassessed to ensure the appropriate use of available resources within the high priority scenario. It is also prudent to seek the opinions of another SAR trained personnel in the form of a consensus.
- 3.11.25 It is appropriate for the SMC to use as many SAR planning techniques as possible to cover all possible situations and eventualities.
- 3.11.26 Searching is the most expensive, risky and complex aspect of the SAR system. Often it is also the only way survivors may be located and assisted. All information received about the incident must be carefully analysed and evaluated before a search is undertaken and at frequent intervals during its progress. In the early stages of a SAR incident, it is almost certain that the SMC will need to make some assumptions about the nature, time or place of the incident. It is very important that such assumptions be kept separate from the known facts. It is important to distinguish conclusions based on known facts from those based partially on assumptions and to record these in the SAR running log. It is also important to re-evaluate all assumptions regularly and as new information becomes available. Any assumption, which is allowed to go unquestioned for too long a period, begins to falsely assume the appearance of fact, and can compromise the search effort.
- 3.11.27 Where possible the Last Known Position (LKP) should be used as the point to begin the initial search. The LKP can be either the location when the target was seen by a credible witness or the location identified from clues or evidence. If the target is responsive and self-helping the LKP may change as clues and evidence are located. This may also identify a direction of travel. In the event that a LKP cannot be identified an Initial Planning Point (IPP) may be used. An IPP is a location from which the missing person is most likely to have left from. A vehicle located at a national park may represent an IPP as they is a likely point of departure even though there are no credible witnesses.

3.11.28 Some of the clues that may indicate the MP's location or situation include:

- a) Their intentions;
- b) Last known position;
- c) Terrain and hazards;
- d) Health, experience and physical capabilities;
- e) Lost person behaviour;
- f) Environmental conditions; and
- g) Results of previous searching.

Search Urgency Assessment (SUA)

3.11.29 A Search Urgency Form will be completed as soon as possible to establish the seriousness of the incident to determine the appropriate response. An example of this form is contained in Appendix E-1.

3.11.30 There are eleven categories to be assessed:

- a) Number of MP's in group;
- b) Age;
- c) Medical conditions;
- d) Intent
- e) Cognitive capacity
- f) Experience profile
- g) Physical condition;
- h) Clothing;
- i) Equipment;
- j) Experience;
- k) Weather; and
- l) Terrain and hazards

3.11.31 Each of the eleven categories are individually assessed in line with information received. Each category is then assigned a number depending upon the situation (e.g. Section 1 relates to the number of missing persons. If there is only one then a number 1 is assigned to that section; if there are two MP's then a 2 is assigned etc.) After the completion of the assessment the assigned numbers are added to determine the overall seriousness of the incident. The appropriate responses are:

- a) 11-17 Immediate response
- b) 18-27 Measured response
- c) 28-42 Conduct further inquiries and re-evaluate the situation

3.11.32 Also, if there is a number 1 assigned to any of the categories then an immediate response is required.

3.12 Terrain Factors

3.12.1 Terrain may be a major factor in evaluating an incident. Terrain may dictate the type of search pattern required, and may limit the selection of search assets that can be used.

3.12.2 Terrain may also limit the time available for search. For example low-level searches in mountain areas are normally limited to daylight only. Equipment, such as the type of hoist device used by

available helicopters will also be influencing factors. Dense foliage may hamper both visual and electronic searches and require increased numbers of aircraft and closer search track spacing.

- 3.12.3 Man-made additions to the terrain such as power-lines, towers and bridges must also be considered when planning search areas and the altitudes of search aircraft.
- 3.12.4 The type of rescue team used after the distress site has been located is also dependent upon terrain. When there is doubt about survivors or the area is inaccessible, time is a factor. Should other help not be readily available, search teams may need to be winched into the search area. Before deploying assets under these conditions, the ability for them to land, to be re-supplied and recovered must be considered.

3.13 Land Environments

Rainforest

- 3.13.1 All rainforests have a crown cover of 80 per cent or more and so are classified as closed forests. Rainforests comprise a significant proportion of Australia's closed forest, but only 2.6 per cent of the total area of native forests.
- 3.13.2 Rainforest ground-covers are often sparse due to the low levels of light under the dense canopies. Understoreys are varied depending on the kind of rainforest. Some are characterised by vines or ferns. Mosses and other epiphytes are often a feature of rainforests. Vine forests are a kind of rainforest characterised by the presence of significant vines growing on the trees. They are largely confined to the tropics and sub-tropics. Rainforest with a significant cover of ferns and mosses are concentrated in the temperate zones and at high altitudes in the tropics.
- 3.13.3 There are many types of rainforest, varying mainly with rainfall and latitude. Tropical and sub-tropical rainforests occur in northern and eastern Australia in the wetter, coastal areas as far south as New South Wales. Dry rainforests are a variation of tropical/sub-tropical rainforest that occur in pockets protected from frequent fire in sub-coastal and inland areas across northern and eastern Australia. Monsoon rainforests occur in northern and north-western Australia in the seasonally dry coastal and sub-coastal regions. Temperate rainforests occur in eastern and south-eastern Australia; warm temperate rainforests in New South Wales and Victoria, and cool temperate rainforests in Victoria and Tasmania, with a few outliers in the high altitudes of New South Wales and Queensland.



Figure 3-27 Distribution of Rainforest in Australia

Rainforest Considerations

3.13.4 The following considerations should be taken into account:

- a) Time frame for Survival (see Volume 2, Chapter 7, Medical Factors). In the rain forest environment it is critical that action is taken to consider time frame for survival. Forests have widely varied weather conditions from tropical to temperate this will impact of the survival time. The temperature variation within rain forests is much less than that of open plains. Because of the canopy and its shielding ability rain forests are slower to heat up during the day and slower to cool down during the nights. This results in a narrower difference between night and day temperatures. Although they are rain forests, and grow primarily due to a higher incidence of rain, there is often a scarcity of surface water, except in those areas with running streams or rivers. The ground is usually moist which has an effect of increasing the humidity of the atmosphere within the forests. This moist ground will also contribute to accelerated core body temperature loss for someone lying on the ground for any length of time. Wind can funnel through these forests, as a result of differences in temperature and air pressure from uneven heating of the canopy by the sun. These winds, coupled with a high humidity, will contribute to greater wind chill than would normally be expected;
- b) Forests will have dense canopy covers which are often multi layered. Dense canopy cover will cause problems with communications (SATPHONE) and navigation equipment (GPS). Secondary communication systems and navigation techniques will need to be employed. Standard navigation techniques, such as identifying a distant object to align a search team on a particular bearing or counting of steps to determine distance, often fail due to the restricted visibility and hidden obstacles on the ground. A search team leader will find it much harder to maintain a search line with more than a small team. In these conditions it is better to have several smaller teams under the overall control of a senior search controller. Compasses will be an essential item, although even the most 'bush savvy' person can easily become disorientated;
- c) Forest density will restrict visibility on the ground (long distance). In the denser areas of the rain forest visibility may be reduced to as little as 2 - 3 metres. Rain, mist and fog can also restrict visibility for searchers. Sparse ground cover is characteristic of rain forests, although

this is often offset by a layer of leaf litter. Depending on the forest and the frequency of natural events this leaf litter will vary in depth, up to as much as 50cm. The leaf litter will hide or disguise potential hazards, such as rocky outcrops and gullies. This will impede search efforts as well as increasing the degree of difficulty for ground teams. Toilet paper or other similar 'forest friendly' marking material will be a necessity to mark the boundaries of search areas as it will be extremely difficult to locate them using standard methods of grid references or GPS points;

- d) Canopy cover will also limit the effectiveness for aerial search – aircraft using Forward Looking Infrared will be unable to penetrate dense canopies with sensors. Thick canopy cover results in little natural light reaching the forest floor. Outside overcast conditions will mean that visibility will be considerably reduced at ground level. A combination of poor light and mist/fog will considerably reduce the probability of detection of a lost person. It may be necessary for search teams to carry portable lights with them and may also limit the amount of search time available to the search coordinator;
- e) While rain forests are spectacular places to visit and sight see they can also have a detrimental psychological effect upon those who are lost in them. The continuous low light levels, lack of direction, apparent never ending forest and dampness will contribute to depression and feelings of despair among lost persons. These same conditions can also affect searchers, but often to a lesser extent. Rain forest conditions can also cause our human primeval fear of the dark, which can result in a lost person moving aimlessly around in the forest seeking an escape. There are very few large animals which will actively harm humans, the exception being the cassowary of northern Queensland, with rain forests, but there are many smaller animals that can cause an unreasonable level of fear in some humans. These include leeches, ticks, spiders and the many nocturnal forest creatures;
- f) Good maps of rain forest areas are not common. The standard practice of aerial cartography does not work well when the ground cannot be seen;
- g) Due to moist conditions it is often very difficult to light a fire, for either warmth or cooking. Artificial means are almost always required, such as small gas cylinders or hexamine. Unless the lost person is well trained in survival it is best to consider that there are no edible fruits or animals within the forest. A large number of plant species are toxic as are the crayfish and eels of rain forest streams if eaten raw.

Rainforest Behavioural Characteristics (missing persons)

3.13.5 Be aware that lost person in rainforest conditions may exhibit any or all of the following:

- a) Failure to make shelter;
- b) May be hidden in the buttress roots of many rain forest fig varieties;
- c) Discard their equipment;
- d) Disorientated – walking any direction;
- e) Tend to walk down hill (depending on level of experience – experienced walkers may try to access high areas to resolve their position or to gain telephone service);
- f) Following a path of least resistance;
- g) Cold Temperate areas – may exhibit characteristics of Alpine areas.

3.13.6 Rainforest Resources considerations:

- a) Experienced Search Teams – with local knowledge and the ability to navigate within a featureless environment;
- b) National Park Rangers – or local rangers;
- c) Police Mounted Assets, Search and Rescue Mounted Assets;
- d) Aviation support – consider limitations;
- e) Tracker dogs, may be valuable first up but will otherwise be easily distracted by the many rain forest smells;
- f) Motorcycles/bicycles- search and rescue trained.

Alpine Environment

3.13.7 Alpine areas relate to high mountainous areas which are subject to extreme environment changes involving rain, snow, hail and strong winds.

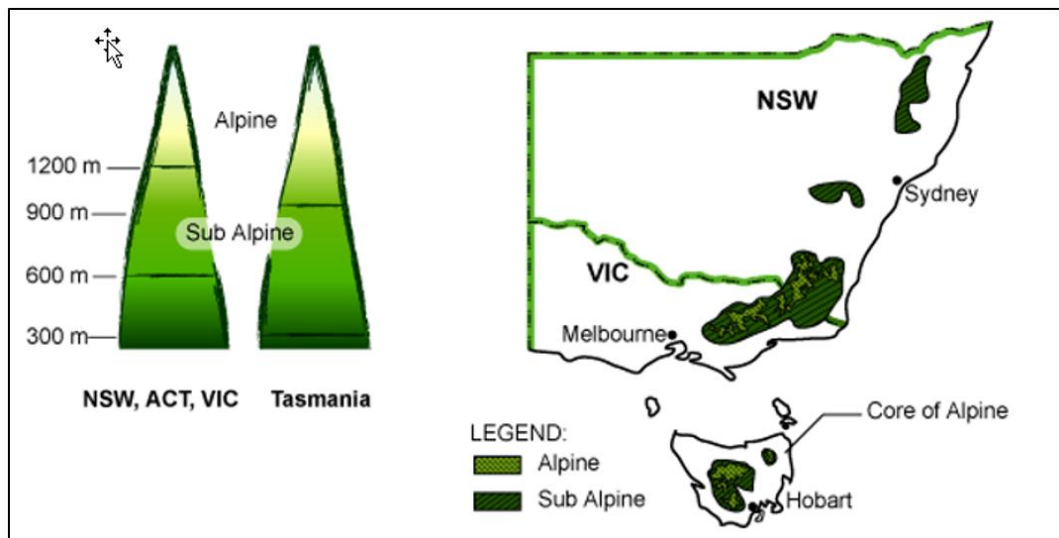

Figure 3-28 Alpine Areas of Australia (dlsweb.rmit)

- 3.13.8 Alpine search teams differ from normal ground search teams mainly due to the different weather, altitude and hazards they must face and the different variety equipment and skills they use to overcome and travel in these hazardous conditions.
- 3.13.9 Due to these hazardous conditions an Alpine searcher should be a trained SAR member skilled in movement over snow & alpine survival skills able to move efficiently, skilfully and with safety in winter or sub winter conditions through terrain at low or high altitudes. This member must be of a high fitness level, able to cope with the physical and mental demands required to move efficiently in this changing environment. All alpine SAR members must be able to work as a team member and be prepared and equipped for overnight survival when necessary.
- 3.13.10 These guidelines are intended to differentiate Alpine searchers from normal searchers to allow for the selection of teams to handle situations that are specific to their expertise and training.

Alpine Considerations

3.13.11 The following considerations should be taken into account:

- a) Equipment - Alpine equipment is very specialized to deal with extreme temperatures and conditions. All equipment should be suitable for the conditions and be checked by a team leader before entering an alpine environment. Poor equipment can put searchers lives in danger.

-
- b) Alpine searchers - Due to extreme conditions and change environment only trained alpine searchers should be used in the field on an alpine search. When entering remote areas a team should be no less than four members who are self-sufficient for overnight.
 - c) Time frame for Survival (see Volume 2, Chapter 7, Medical Factors) In Alpine environment it is critical that immediate actions be taken to reduce the likely risk of exposure to hypothermia of the missing person/s.
 - d) Medical training - Due to difficult access and remoteness of an alpine search, Paramedics or equivalent medical expertise in search teams or readily available to render assistance.
 - e) Search techniques and search patterns – A search manager should utilize local knowledge of Alpine SAR members and/or ski patrol to assist in search tactics due to alpine mobility issues of search teams and lost persons.
 - f) Restrictions in mobility of search teams and lost persons. Allow for greater time periods in the travel of distances.
 - g) Makeup, search technique and search patterns used by searchers.
 - h) Avalanche risks - A search manager should use only trained avalanche specialist in declaring search areas safe and when leading search teams in specialized searching using probes and avalanche receivers.

Alpine Behavioural characteristics (missing persons)

- 3.13.12 Hypothermia is the lowering of a body's core temperature (see Volume 2, Chapter 7) and is the most common condition missing persons will suffer from in an alpine environment. A search manager and team leaders should be aware that lost person in alpine conditions may exhibit any or all of the following:
- a) Failure to make shelter
 - b) Discard their equipment
 - c) Disrobing of clothing (Paradoxical undressing as a result of severe hypothermia)
 - d) Failure to respond to searchers
 - e) Following a path of least resistance
- 3.13.13 This should be considered when clothing or equipment is located by search teams.
- 3.13.14 The majority of missing persons in alpine environments wear high visibility clothing and equipment. Due to changing weather conditions they become disorientated, misjudge distances and become benighted.
- 3.13.15 Alpine Resources considerations:
- a) Overland snow/all-terrain vehicles
 - b) Ski patrols
 - c) Alpine horse riders and bush walkers from volunteer rescue agencies
 - d) Aviation support
 - e) Thermal imaging / night vision
 - f) Avalanche specialists
 - g) Mountain trained members in mountaineering, steep, snow and ice techniques
 - h) GPS – carried by search teams
 - i) Medical staff on standby.

Arid Environment

- 3.13.16 Australia is the world's driest inhabited continent. Over 70% of the continent receives between 100mm and 350mm of rainfall per year, classifying it as semi-arid or arid. Desert regions are found mostly in central and Western Australia, which makes up approximately 18% of the mainland. All of Australia's deserts are classed as subtropical deserts, given their location between the latitudes of 20 degrees and 30 degrees south of the Equator. They are hot deserts, which means they have little rainfall and extreme temperatures, often reaching over 50°C. Humidity averages at between 10 and 20 percent. Searing day time temperatures, cold nights and lack of surface water are just a few of the challenges facing travellers in the desert.

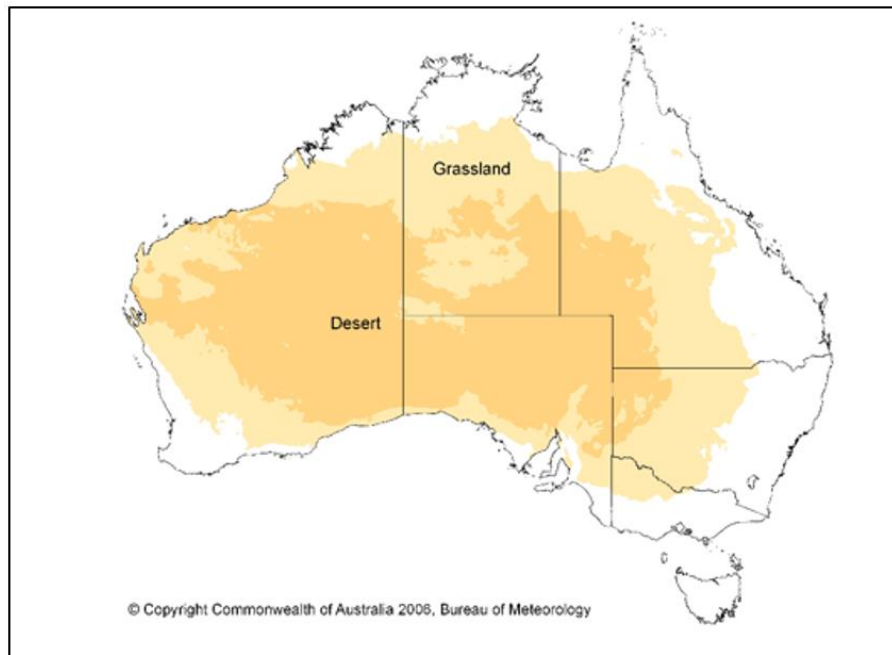

Figure 3-29 Distribution of Deserts

- 3.13.17 Desert surfaces are not always sandy; some consist of stones or 'gibbers' and have no sand at all. Sandy deserts in Australia are The Simpson Desert, The Great Sandy Desert and the Great Victoria Desert. Stony deserts include The Gibson Desert, and the Sturt Stony Desert.

Arid Environment Considerations

- 3.13.18 In desert conditions, because of the extremes of temperature, both hyperthermia and hypothermia can affect the missing person. The amount of water carried and the methods which it is used by the missing person can have a critical effect on survival times. During the initial action stage an assessment of the target needs to be made in relation to their possible actions while the search is being conducted. Persons who are level headed and remain in a sheltered or shady location will survive for much longer periods than a person who is attempting to self-help by walking throughout the day. The general rule is for a target to remain with their vehicle if lost as it is far easier to find a larger object such as a vehicle than a smaller target such as a person.
- 3.13.19 Historically most targets will spend a small percentage of time with their vehicle and then decide to walk off in search of help. In areas that are familiar to the target this may be a successful strategy, but in most instances it results in death.
- 3.13.20 It is unusual for the SMC to be the first person on the scene of a SAR incident. Vital clues as to the direction, speed and condition of the target can be gathered from observations of their footprints or other markings in the immediate vicinity of a vehicle. Consideration should be given by the SMC to brief all teams about the possible destruction of clues around vehicles. When the target's vehicle is located one team member should approach it from the hardest surface possible to ascertain if there are persons inside or if notes or other information has been

left. The area in the vicinity of the vehicle should then be thoroughly inspected for footprints and other marks and the direction in which they are going. Further planning can then be made on the information obtained. If there are no obvious signs left at the vehicle, then this would be used as a possible LKP with search planning concentrated on that point.

- 3.13.21 In featureless country it is almost impossible to navigate accurately without extensive equipment. A target will often aim to walk a straight path but in reality will wander. The handedness of the target will provide a clue the direction of the wanderings. Right handed persons will tend to walk in circles veering off to the left, with left handed persons going in right hand circles.
- 3.13.22 Mental condition will also play a significant part in the survival of the target. There are many stories of the explorers surviving tremendously difficult conditions without water for days. Historically this has been attributed to the harder living conditions and tougher life styles of those explorers. With the increased pampering of people today the physical ability to survive in harsh desert conditions has diminished. The mental state will have a large effect on a target's survival. Those with a 'no give up' attitude may have better odds of survival than a person with no will power.

Arid Environment Behavioural Characteristics (missing persons)

- 3.13.23 Be aware that lost persons in arid conditions may exhibit any or all of the following:
- May shelter in or under their vehicle;
 - May dig themselves in under the sand, if experienced;
 - May discard their equipment;
 - May become disorientated – walking any direction;
 - May sleep by day and walk by night, if experienced;
 - Following a path of least resistance; and
 - May seek out river beds and ranges in search for water.

Arid Environment Resource Considerations

- 3.13.24 The following resource considerations should be made:
- The use of indigenous trackers or visual trackers;
 - Making aviation search a priority;
 - The use of trail bikes and helicopters;
 - Use of helicopters for transport of searchers and logistics supplies;
 - Hardening experienced Search Teams to the environment; and
 - The use of ground teams to recover the missing person once located, unless a helicopter has access.

Mountain Environment

- 3.13.25 Although Australia is considered the flattest of the world's continents it does contain some significant mountain areas with respect to SAR. Whilst about 10% of the country may be considered mountainous due to the elevation, a much smaller proportion contains areas of high relief that create substantial SAR issues. Due to the fact that many of Australia's mountain areas are National or Wilderness Parks they are often in close proximity to many of Australia's largest population centres.



Figure 3-30 Mountain Areas are highlighted in Light Shades

Mountain Considerations

- 3.13.26 **Access:** Many mountain areas are in wilderness or National parks. As such access into these areas is often limited. Resources in terms of searchers often have to trek great distances to reach their allotted search areas. Air support may not be available due to weather conditions, terrain or vegetation. Additional human resources may be needed to move equipment.
- 3.13.27 **Communications:** Many of the mountain areas are not serviced by regular communication networks. It is important to liaise with emergency services that may be able to provide additional portable sites to improve forward net coverage. Even with additional radio communications, there will be no guarantee of continuous coverage. It means that briefings and operational instructions to Team leaders must be absolutely and thoroughly conveyed.
- 3.13.28 **Containment:** It is almost impossible to contain an area in mountainous terrain to keep the target within it. The importance of continually monitoring trails, significant points, logbooks or known 'trap points' where persons could move through is essential.
- 3.13.29 **TFFS:** In mountainous areas the targets are often adventurous, with activities such as bush walking, canyoning, trekking, rafting, abseiling and climbing. Often the report of a missing person will not be received until the person is well overdue. With many adventurous activities extending over many days, time becomes critical as injury or misadventure may well have occurred earlier in the activity. Therefore, the missing person or group may well be approaching their TFFS by the time emergency services are notified. Search strategies that emphasise fast and reconnaissance methods are indicated.
- 3.13.30 **LPB:** Persons who venture into mountainous areas are often motivated and aim to achieve a task. Ascertaining as much data as possible regarding the MP will enable the SMC to determine the likely characteristics of the person. Often these persons are trail orientated and will seek water and/or shelter if injured (see Appendix E-5).
- 3.13.31 **Vertical Rescue:** Where called to search areas of high relief for missing people it is advisable to ensure that emergency services with skills in Vertical Rescue are placed on Alert or called to be part of the search so as not to delay the arrival of these trained operators should they subsequently be needed.

-
- 3.13.32 **Training:** High levels of fitness and resourcefulness are needed as Mountain search crews may well be deployed not only in difficult terrain but over protracted days without opportunity of relief in often poor or changeable weather. Excellent navigation and map reading skills are required in any search team. The ability to effectively use GPS technology should also be considered as a skill within each search team.

Mountain Environment Search Strategies

- 3.13.33 Contain any search area as quickly as possible. This can be done by using FAST and reconnaissance strategies in deploying teams to tracks, LKP, intended destination, lookouts, major campgrounds or known 'trap points' where a person or persons must pass through. These would be the initial high probability areas.
- 3.13.34 Many mountainous area and lookouts contain logbooks or visitors' books. It is imperative that these are checked as soon as possible in an effort to narrow down the search area.
- 3.13.35 Set up a forward net communication as soon as possible.
- 3.13.36 Postpone a general search strategy until there is clear evidence or a definite clue to the missing person's whereabouts (e.g. Found backpack, clothing, footprints etc.) Be flexible about search team sizes, e.g. A team of 2 where communications is excellent across most of the area being searched, a team of 3 where communications is intermittent and a team of 4 where communications is poor or marginal.
- 3.13.37 A search team of 3 is a very flexible team size as this size can strike a good balance between rapid movement and deployment and team security. A team of 3 can search in a Single File, Track Sweep, Point and Flank and Purposeful Meandering.
- 3.13.38 Use the 'call and listen' techniques. Note that in calling from a ridgeline, the sound will not travel down the sides of a ridge or spur, sound will only travel out to the facing slopes. It is important to therefore call out from opposite ridges into a valley.
- 3.13.39 Caves and Mines: Enthusiasts are now delving deeper and further underground into increasingly more difficult areas of caves or abandoned mines. Caves and older mines pose many problems to both the caver and potential rescuers, including narrow constrictions, vertical shafts, water at varying levels, risk of collapse and rock falls, bad air and almost complete darkness. Search and rescue in these environments should only be undertaken by trained specialists. There are several spelunking groups in the southern states and most of the underground mines have mine rescue specialists that could be called upon in an emergency.

Urban searching

- 3.13.40 Urban Environment: Land searches in urban areas are often required for targets such as those intending suicide and those with dementia or similar ailments. The general strategy employed for urban search is similar to that of the rural or 'bush' search, but the problems encountered are different. Urban search problems include:
- Greater number of places of concealment;
 - Complicated search areas;
 - Greater number of property owners; and
 - Distinguishing between the missing person and the local population. It is vital to have a good description and preferably, a current photograph of the missing person or object.
- 3.13.41 Urban Search (Major Complex): In the case of a major complex, e.g. a large hospital, each of these stages would be included within the boundaries of the complex. If the lost person is not found, then a new search area surrounding the complex is determined:
- Reconnaissance;
 - General search; and
 - Building/contact search.

-
- 3.13.42 Though the stages are similar to that of a rural search, variations to some of the methods and techniques are required.
- 3.13.43 Urban Search - Major Complex: In the case of a major complex, e.g. a large hospital, each of these stages would be included within the boundaries of the complex. If the lost person is not found, then a new search area surrounding the complex is determined.
- 3.13.44 Urban Search Area Segmentation: The same segmentation principles apply as for rural search operations. Boundaries will generally be defined by artificial features, such as roads, drainage channels, railway lines and major complexes (industry, commerce, government). Some natural features which may form boundaries include rivers, shorelines and nature strips. Where roads are used as boundaries between search segments, the boundary would normally follow the centre line of the road.
- 3.13.45 Urban Environment - Reconnaissance Search: The reconnaissance stage requires small search teams to carry out a quick check of specific areas of high probability within the area of possibility. Areas which should be checked during the reconnaissance stage:
- Locations that are familiar to the lost person, e.g. current or previous residence, the home of friends and family, church, hotel, even if assurances are given that these areas have been checked.
 - Hazardous areas e.g. construction sites, quarries, rooms/buildings that are rarely used (locked or unlocked).
- 3.13.46 Urban Environment -General Search: A general search stage is carried out in an area of probability, checking for signs or indications of the missing person. A check of such places as public buildings e.g. public toilets, railway station and other shelters, such as store and plant rooms or a large building, large culverts and beneath bridges, should be carried out. A special check of hazardous areas, including railway tracks, banks of rivers, lakes, swimming pools, drains, dams and construction sites where the missing person could be trapped or injured, should be made.
- 3.13.47 Urban Environment - Building/Contact Search: Building search as it implies, requires the systematic searching of each and every corridor, room and possible place of concealment within a building. Several buildings may be contained within one property, therefore requiring a systematic search of the property surrounding the buildings. Always gain permission to search property or seek police assistance. Building searches in large complexes, such as a hospital or shopping centre, present a different problem. Divide these buildings into sectors by wings or, in the case of a multi-story building, by floors. Appoint a separate team leader for each of these sectors and, where possible, have a member of the staff who occupy the building (with knowledge of the building) accompany the team leader.
- 3.13.48 The team leader must progressively report those areas searched and list those areas not searched, ensure that they are searched, later.
- 3.13.49 Urban Environment, Conclusion: Don't be misled by thoughts or statements such as 'there wouldn't be anyone in there', or information like 'I've already searched that building'. If you have the responsibility to search an area, then you make sure that you or those for whom you are responsible cover the whole area.

Forensic Searching

- 3.13.50 Forensic Search: The Police may request assistance with searching for forensic evidence. A high level of skill and motivation is required as searchers may be required to spend long, sometimes tedious, hours scanning small areas for any evidence such as:
- Human teeth/bones/prosthetic devices
 - Bullets and/or bullet casings
 - Hair

- d) Jewellery
- e) Shoes/clothing
- f) Footprints
- g) Weapons.

3.13.51 The method employed will usually be a contact style search:

- a) Members crawl on hands and knees, often shoulder to shoulder, with no gaps in the search line
- b) The ground is intensively and physically searched in front of each searcher to the width of their shoulders or midway to the adjoining searchers. All ground matter, leaves, rocks, stones and loose soil is examined.
- c) The search progresses at approximately 1 (One) metre per minute or slower depending on the thickness of ground cover and terrain.
- d) All the principles for preserving clues are applied
- e) Items of interest are identified without moving where practicable. Forensic guidance will determine if the item is applicable to the search. If so it will be photographed insitu, bagged and tagged for further examination by police.
- f) Specialised searching may require the bringing of soil and/or vegetation to a sorting table or bench for sifting.

Land SAR Resources

3.13.52 Resources: While there are a wide range of resources available throughout Australia to assist the SMC conducting a SAR mission, not every resource will be available in every location for each search. A SMC should ensure that they keep an up to date register of available resources within their SAR area, including telephone numbers and alternatives, man power and equipment, capabilities, travel times and other information.

3.13.53 Resources must be assessed in terms of capability, availability and durability. Such resources are:

- a) Human; and
- b) Physical resources.

3.13.54 Human Resources: Human resources should be categories as trained and untrained. Trained searchers must be proficient and effective in skills such as:

- a) Leadership;
- b) Working as team members; and
- c) Use of map and compass, bush craft, communications, first-aid, skiing, etc. have an understanding of the organisational functions supporting the operation.

3.13.55 It is preferable to use trained teams who are experienced in working together. This however, is not always possible. If untrained searchers are to be used, they must be under the control of a trained and experienced leader. People with specialist skills should be utilized within their area of expertise. The tasks allocated to teams need to be within the capacity of those teams. This includes their area of search, terrain, conditions and functions.

3.13.56 Human Trackers: The art of tracking a person through bush is fast vanishing; however, it should not be overlooked as a means of finding a missing person. In parts of Australia, there are indigenous people who have maintained this art and there are others who have developed these skills.

3.13.57 If a suitable tracker is available, consideration should be given to their use as valuable time can be saved by going directly to the missing person rather than conducting a slow methodical search. This does not mean that if a tracker is available, there is no need for search teams.

-
- 3.13.58 Trackers are not infallible and tracking over rocky ground or through swamps may not be possible. Where the tracker has lost the trail or cannot proceed, the search team takes over until the trail is relocated. The tracker and the search team can and must work in harmony, but the team must ensure that they do not obliterate the trail which the tracker is following. Trackers use visual tracking techniques, the requirements for which are good eyesight, memory, practical intelligence, fitness and an understanding of nature.
- 3.13.59 Physical resources: Physical resources available to each area will be many and varied, each having a special function. Therefore, each should be employed accordingly. Such resources include:
- a) Aircraft;
 - b) Vehicles;
 - c) Horses;
 - d) Dogs; and
 - e) Vessels.
- 3.13.60 Aircraft: There are aircraft available to suit specific circumstances. Provided weather prevailing in the area is suitable, aircraft can cover an area quickly and economically, thus relieving the problem initially of utilizing ground teams. Aircraft are particularly useful in the reconnaissance stage.
- 3.13.61 Fixed Wing Aircraft:
- a) This should preferably be of high-wing monoplane construction, with a low stalling speed, economical fuel usage and an air dropping capability. This will allow good visibility from the aircraft and a viable time period over the search area.
 - b) Refuelling points should be as close to the search area as possible.
 - c) Observers should be trained and rotated regularly.
 - d) In protracted flying operations, consideration must be given to the limitations of flying hours for the pilot(s).
- 3.13.62 Rotary Wing Aircraft: due to their ability to hover and fly slowly helicopters are a very valuable land SAR assets and are also a common form of rescue platform. Specialised SAR helicopters are usually equipped with a winch and night search capability. They normally also have mobile telephones and a variety of radio communications, GPS and can often land near the search area. Each state has SOP's regarding the use of helicopters in searches.
- 3.13.63 Helicopters, advantages: Some of the advantages of using a helicopter are:
- a) Large open areas can be searched with relative speed.
 - b) Water areas can be searched in most weathers when a surface search may be dangerous.
 - c) The size of the area covered may reduce the necessity of other resources.
 - d) Good observation capability.
 - e) Can give the SMC an overall appreciation of the search area.
 - f) Routes can be identified.
 - g) Hazards to searchers can be identified.
 - h) Rooftops of buildings can be searched without risk.
 - i) If equipped, night search can be aided by a Nite Sun (searchlight), NVIS and EO/IR.
 - j) May enhance public perception of the search.
 - k) Assist in the coordination of ground resources.
 - l) Have the capacity to hover over and land in remote locations.

- m) If the aircraft is fitted with a hoist (winch), placement or extrication of individuals may be accomplished without landing. In protracted flying operations, consideration must be given to the limitation of flying hours for the pilot(s).

3.13.64 Helicopter, Disadvantages: Some of the disadvantages include:

- a) Effectiveness is governed by the weather.
- b) Restricted visibility by forest canopy, buildings etc.
- c) Restricted flight times
- d) Requirement for fuel in the more remote areas.
- e) FLIR unable to penetrate forest canopy.
- f) Restricted operating distance from shore in the marine environment.

Dangerous Animals

3.13.65 Australia is known for its wildlife and every year thousands of locals and tourists gravitate to wildlife parks to view and hold our cuddly furry creatures. It is not these that searchers need to worry about, it is the more unpleasant looking critters that cause the problems.

3.13.66 **Saltwater Crocodiles:** The Australian Estuarine or Salt Water Crocodile is found across the entire north of Australia as per the below map. They are the largest reptiles in the world growing up to 5-6 metres in length. The Salt water name is a misnomer as they are quite happy in fresh water billabongs long distances from the coast. They are very aggressive and territorial. While their normal diet consists of wild pigs, water buffaloes, cattle and horses they will also eat the occasional human. On average 1-2 people are devoured by crocodiles somewhere in Australia per year.



Figure 3-31 Areas known to be inhabited by Crocodiles

3.13.67 When searching in areas known to be inhabited by crocodiles it is imperative that all members of a search team keep a very good look out. It may be worthwhile having a member of the State/Territory Parks and Wildlife Service or Crocodile Management Team accompany any search team as they will be able to identify crocodile habitats and signs of recent crocodile activity. A firearm may also be prudent in some circumstances, but only at the instruction of the SMC.

3.13.68 **Snakes:** Be aware of what snakes are likely to be encountered within a search area. Australia has a great many of the world's most venomous snakes and apart from the colder reaches of the Tasmanian and mainland Alps they can be found just about everywhere. Very few snakes are aggressive towards humans by nature but all will respond to being trodden on, poked and

prodded. Most will slither away from searchers long before they are spotted but occasionally a snake will be caught out in the open by an unsuspecting team member. Common sense prevails in most situations. Remain calm and still and let the snake leave the scene under its own steam. Do not try to pick one up or hurry them along. In the heat of the moment it is difficult to identify the harmless from the dangerous. Treat all snakes as being dangerous and remember that they are protected.

- 3.13.69 If bitten by a snake remain calm. Have another team member commence first aid in the form of a pressure immobilisation bandage and immobilise the area. Seek medical assistance. Do not wash the area as any residual venom may be able to be identified. Most major hospitals carry anti-venom for snakes in their area. Where possible identification should be made of the snake that caused the bite but do not attempt to apprehend the snake as another bite may result.
- 3.13.70 **Spiders:** There are a wide range of venomous spiders scattered throughout the country, all of which do not actively stalk humans. Most spider bites arise from the spider being disturbed. Wearing gloves when searching undergrowth, under objects or back yards and stout footwear will prevent many potential spider bites. If bitten by any spider seek medical attention as soon as possible. Identification of the spider can assist with any medical treatment provided.
- 3.13.71 **Scorpions, Centipedes and Millipedes:** As per spiders these creatures can be located throughout Australia. While all of them are not poisonous they can all cause a very nasty sting. Gloves and footwear will prevent most encounters from turning nasty.
- 3.13.72 **Tasmanian Devil, Dingoes, Foxes, Goannas, Monitors, Birds of Prey:** While not dangerous these animals have one SAR related characteristic, they all feed on dead or decaying animals, including humans. If it is possible that a MP is deceased then there is a possibility that local animals have had the opportunity to devour some or all of the flesh and to scatter the bones. This may be the case with a person missing in the outback or more remote areas. The SMC should be aware that this detail should be included in the briefings, for teams to also look for scattered human bones and remains.

Telephone Triangulation

- 3.13.73 With most people now carrying mobile telephones the potential for telephone triangulation by the various telephone carriers can reduce SAR efforts dramatically. During the information gathering stages it should be canvassed as to whether the MP has a mobile telephone with them. Something as simple as making a telephone call, sending a text message or leaving a voice message may resolve a SAR incident. If these methods do not produce results, contact with the service provided can often produce a location or direction from a mobile telephone tower. The individual State/Territory methods in contacting service providers will differ, as will any charges that are made by these providers. If the MP is in an urban area and their telephone is on, a triangulation can be reasonably successful within a small space of time. A large number of mobile telephone towers in an area can produce a very defined search area, whereas a small number or only one tower will produce a much larger search area, such as a bearing and distance from a particular tower. MP's lost in rural, mountainous or remote areas may have little mobile reception, with an associated small chance of triangulation. Mobile telephones with dead batteries will not be of much use. A triangulation should be requested as part of the initial intelligence gathering.

Land Search Planning

- 3.13.74 Estimating the Missing Person Location: The search plan consists of two components:
- a) Reflex Tasking (Initial Search)
 - b) Formal Land Search.
- 3.13.75 The search response has been separated into two distinct actions; Reflex or Initial actions and a Formal Land Search. The reflex action is exactly as it says, an instinctive search of those areas

near the LKP or IPP where the MP could have met with trouble. The formal search is one utilising the four search strategies as discussed further in this section.

Reflex Search

- 3.13.76 Reflex tasking can be likened to a bicycle wheel with the hub situated on the LKP or IPP. The spokes represent the various routes, tracks, trails or directions that could have been taken by the MP. The tyre represents the limit of the reflex search which is recommended at 300-500m. The reflectors represent places of high probability within this reflex area. These could include huts, track junctions, hazards, lookouts, cliffs and water courses.
- 3.13.77 A reflex task requires minimal planning and it used as a first response search. The first SRA on scene can be tasked while the SMC is on route.

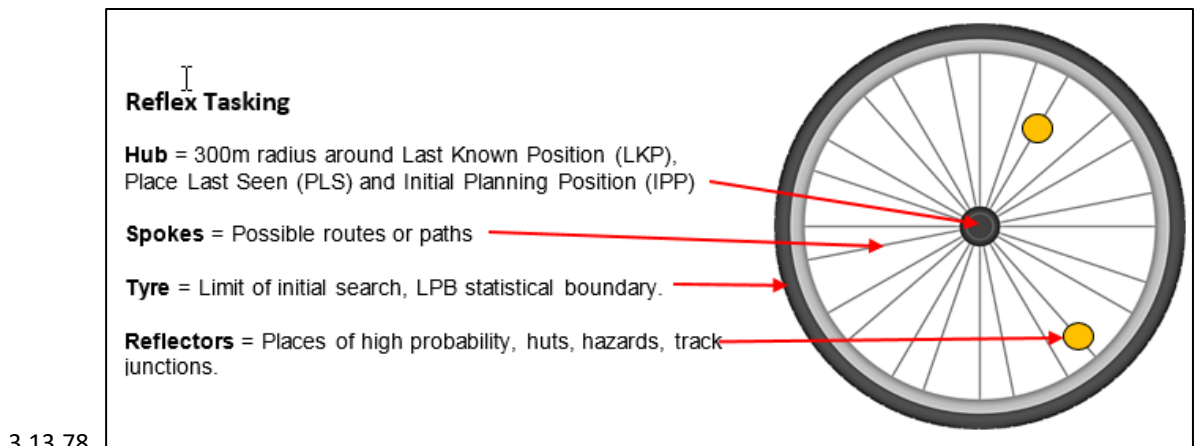
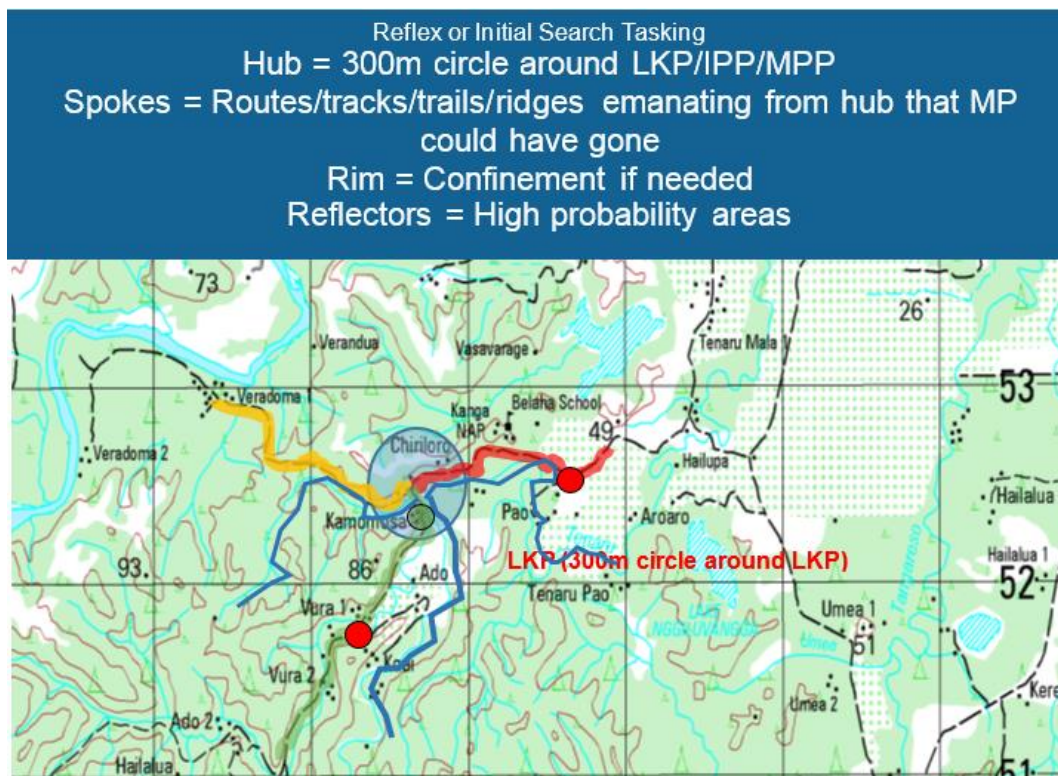

Figure 3-32 Bicycle method for Reflex Tasking

- 3.13.79 The below diagram illustrates this concept. There are six identified possible routes, 3 tracks radiating from LKP and three water courses. Without any further intelligence each is as likely as the others. The circle around LKP is a 300-500m radius for the reflex search. The green reflector is an area of high probability inside the reflex search area (Group of huts) while the red reflectors are high probability areas, track junctions, just outside the initial search.



3.13.80

Figure 3-33 Reflex tasking example

3.14 Formal Search (Land)

3.14.1 There are four strategies in determining the formal search area in a land environment:

- a) Theoretical (How far could the MP have travelled in the time period)
- b) Statistical (Using Lost Person Behaviour, what is the statistical distance the MP could be located within)
- c) Subjective/Decision Points (Using the terrain to determine likely search areas)
- d) Deductive (Looking closely at the facts, clues and assumptions)

3.14.2 Each of the methods are laid over each other to give a very accurate representation of the situation, and if done correctly will serve to reduce the search area to the highest probable locations.

Theoretical Search Strategy (Naismith's Rule)

3.14.3 The first step in land search planning is to determine the limits of the area containing all possible MP locations. This is usually done by determining the maximum distance the MP's could have travelled between the time of their last known position (LKP) and the known or assumed time the SAR incident occurred. By utilising Naismith's Rule a general indication of the maximum distance that could be travelled by the MP will be obtained. Using this as the radius a circle can then be drawn around the LKP, which will indicate the maximum distance the MP will have walked from the LKP. This method only works when it is known that the MP does not have access to other forms of transport. Knowing the extreme limits of possible locations allows the SMC to determine where to seek further information related to the MP's and whether an incoming report might apply to the incident. However, systematic search of such a large area is normally not practical.

3.14.4 Time missing: This time is calculated from when the MP was last seen (Time last seen TLS), not the time they were reported missing or the time they were due back. If there is no definite time

last seen this may have to be estimated, on similar lines to estimating the IPP if a LKP is not viable. Commencing this calculation from TLS is done because an incident may have occurred at any time between when they started their activity and the planned return time.

3.14.5 **Naismith's Rule:** In gauging the speed of travel, Naismith's Rule describes the distance a person may travel per hour over flat terrain and was devised in 1892.

5 km/hour - Easy going over open country.

3 km/hour - Easy scrambling over rocky ground.

1–1.5 km/hour - Difficult going through thick scrub, heavy sand or snow.

3.14.6 Where a person is missing for extended periods or is likely to traverse hilly country, the possible search radius will need to be reduced due to fatigue and slower travel. For each 500 metres of ascent or 1000 metres of descent over the estimated distance travelled, reduce the possible search radius by the equivalent of one hour travel. For every 5 hours the person is missing, reduce the possible search radius by the equivalent of one hour travel for fatigue. The calculation for the possible distance travelled by the MP is relatively simple to perform. Appendix E-6 and E-7 expands on Naismith's Rule and provides further information.

3.14.7 **Example:** A 3 year old MP has been missing 13 hours in the Lamington NP. The intended route suggests medium conditions or easy scrambling (3kph) with a 500m ascent and a 500m descent.

13hrs missing -

1. Calculate any fatigue by dividing the time missing by 5 and ignore any remainders.
($13 \div 5 = 2 \frac{3}{5} = 2\text{hrs}$) $13\text{hrs} - 2\text{hrs} = 11\text{hrs}$

2. Calculate any ascent
Rule is for every 500m of climbing one hour of travel time is taken off:
 $500\text{m} = 1\text{hr}$. $11\text{hrs} - 1\text{hr} = 10\text{hrs}$

3. Calculate any descent
Rule is for every 1000m of going downhill one hour of travel time is taken off, therefore 500m would be the equivalent of 0.5hrs being taken off the total:
 $500\text{m} = 0.5\text{hrs}$. $10\text{hrs} - .5\text{hr} = 9.5\text{hrs}$.

4. Calculate distance travelled
 $9.5\text{hrs} \times 3\text{kph} = 28.5\text{km}$

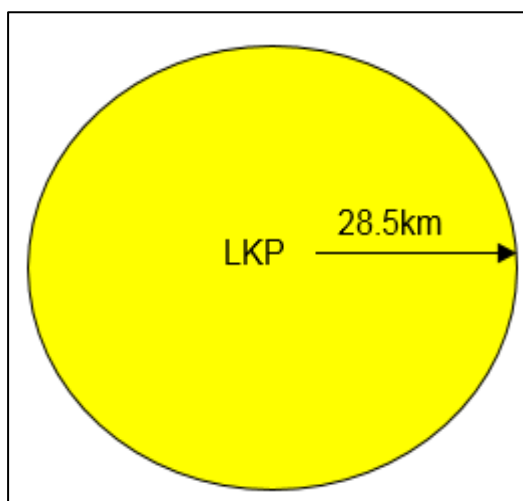

Figure 3-34 Theoretical search using Naismith's rule

3.14.8 It is very unlikely that a 6 year old child will have walked 28.5km however, this is an indication of the maximum distance it could be possible to walk in the time frame. Without using Naismith's

Rule, this calculation would have been $13\text{hrs} \times 3\text{kph} = 39\text{km}$. The area encompassed by a 39km radius circle is vastly larger, almost double, that of a 28.5km circle.

- 3.14.9 This initial calculation provides the SMC with a possible distance that the MP could have travelled in the time since they were last seen. It does not provide a direction or take into account any other factors, including age or behaviour, at this stage. This area is much too large to search adequately, being approximately 2550km^2 . Being a theoretical distance it is highly probable that this distance would not be walked in a straight line but that the MP would wander somewhat and cover a shorter linear distance from LKP.

Statistical Strategy (Lost Person Behaviour)

- 3.14.10 **Lost Person Behaviour:** This method relies on Lost Person Behaviour (LPB) to determine the distance that the MP may have travelled from the LKP. By analysing the behaviour of past lost persons in similar situations, it may be possible to 'predict' what the target now being sought might do, where he/she might go or where he/she might be. This concept is a search planning tool, dealing with generalities, and not absolutes. Lost person behaviour studies provide the SMC with two important items:
- Behaviour traits of lost persons by category.
 - Distances travelled by specific categories of lost person.
- 3.14.11 **General Categories of Lost Persons:** The following are the commonly used categories of lost persons:
- Children 1 to 3 years
 - Children 4 to 6 years
 - Children 7 to 12 years
 - Adolescent Youth 13 to 15 years
 - Mental Development Problems.
 - Despondent
 - Psychological problems
 - Bushwalkers
 - Dementia/Alzheimer's
 - Climbers
 - Hunters
 - Prospectors
 - Children with ADD, ADHD, Asperger's and Autism
- 3.14.12 Appendix E-5 contains lost person behaviours in the above categories and provides statistical strategies, characteristics, locations and distances travelled by members of each group. This will be useful in creating the linear graph as outlined below.
- 3.14.13 Pertinent characteristics set each category apart. Although each of the groups exhibit specific traits, there are always exceptions and good search strategy concentrates on the most likely. The statistics provided further on relate to the activities of 80% of persons in each category. Knowledge of the actions of the remaining 20% of persons in each category may be useful in planning for search containment. (Appendix E-5).
- 3.14.14 An initial Australian LPB study was conducted between 2000-2006. The statistics used in this manual are a combination of those developed in Australian, USA, Canada and the United Kingdom. While these statistics will provide a solid base upon which to base a Statistical Search method there are some discrepancies when used for Australian subjects. Studies to date have

found that due to the more favourable climate in most of Australia and the more outdoor nature of Australians their behaviour when lost is somewhat different, in that they will often attempt to self-help more often. Bearing this in mind, the international statistics can be used with confidence as one of a number of search planning methods. The current Australian Lost Person Behaviour Statistical base commenced in 2010. Entries into the LPB database can be made at <http://goo.gl/OLZmW>

- 3.14.15 The Lost Person Behaviour statistics have been put into a tabular format showing the average distance at which a variety of person groups have been located in relation to LKP. The tables cover all of the statistics but is suggested that the statistics to 80% only be used as the remaining 20% of targets skew the figures as can be seen.
- 3.14.16 Creating a linear percentage line as below will provide a visual representation of the distances that a MP could be located. The table of figures for one (1) – three (3) year old children have been reproduced below. This table shows that 10% of missing children in this group were located within approximately 110 metres of LKP. It also shows that 80% of children in this age group were located within approximately 2.10km of LKP. Using these figures a linear graph of the respective percentages can be shown in a form that more easily translates to map distances. The SMC can place LKP over the position on a map and then draw circles of various sizes to represent the statistical distances travelled by children of that age group.

% of MP's	10%	20%	30%	40%	50%	60%	70%	80%	95%
Dis from LKP (KM)	0.11	0.25	0.30	0.42	0.60	1.15	1.6	2.10	4.45

Table 3-3 Statistical distances travelled by Children 1-3 years (contained in Appendix E-5)

- 3.14.17 Using the LPB tables to produce a Linear Percentage line a SMC can observe that statistically 80% of missing child between 1-3 years of age will, on average, be located within 2.10km of the LKP. Using the statistical method the initial search for a child of that age will be a circle with a radius of 2.10km.
- 3.14.18 Superimposing this search area over that of the Theoretical method will show a dramatic reduction in the probable search area.

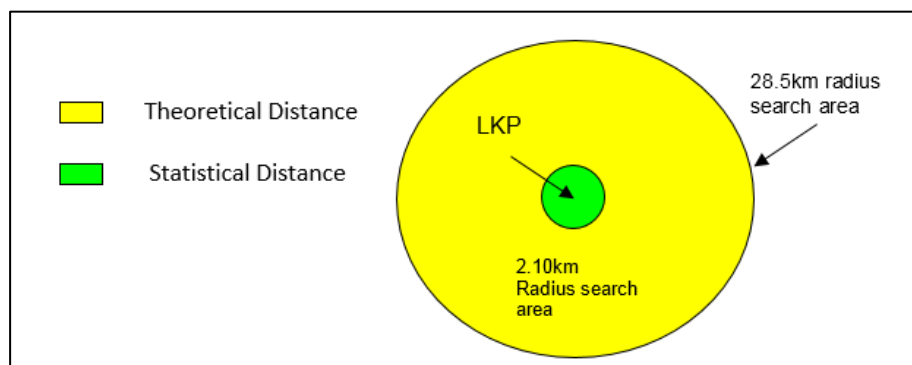

Figure 3-35 Comparison of Theoretical and Statistical Search Areas

- 3.14.19 The probable search area has been reduced from approximately 2,550km² to approximately 13.8km² based on the first two of the planning steps. Using the theoretical method it is possible, although not likely, that the child has walked 28.5km from LKP in the 13 hours they have been report missing and this is portrayed in the yellow circle above. LPB suggests that 80% of all children of this age lost have been located within 2.10km of LKP, represented by the green circle. The SMC must always be cognisant that there are 20% of children in the age group that were not located within that distance due to other circumstances. Continued intelligence gathering will

assist in determining whether the MP fits into the 80% or 20% category. While the statistical area is considerably smaller than the theoretical area it is still an extremely large area to search on foot.

- 3.14.20 In those instances where a missing person may fit into two or more LPB categories (for instance 8yo autistic child), consideration should be given to using the category that has the larger search radius while taking into account the characteristics, traits and strategies of all relevant categories.

3.15 Subjective/Decision Point Strategy (Land)

- 3.15.1 The subjective method uses the terrain, boundaries, fences etc. as a method of identifying a search area. As most categories of targets tend to take the path of least resistance, i.e. walk down hill, identifying the lay of the land will suggest funnels that will channel a target in a particular direction. This method will differ from person to person.
- 3.15.2 The reduction of the possible search area to the probable search area requires the evaluation of factors of the missing person that may reduce their distance travelled, and terrain features and their effects:
- a) Factors which may reduce the projected travel may include:
 - i) Physical condition;
 - ii) Age and sex;
 - iii) Experience in the area and general outdoor ability; and
 - iv) Weather.
 - b) Certain terrain features may also assist in reducing the search area to only a sector of the original circle of the possible search area. For example, features which cannot be crossed or only crossed with difficulty, (fast-flowing rivers, gorges, cliffs, shorelines or very dense scrub) can significantly limit the area which must be searched. The probable search area may only be a fraction of the possible search area when all these factors are applied.
- 3.15.3 On the below map the search area has been identified by the circle. The roads, tracks, creek and ridge lines have been identified and coloured for clarity. These are all potential barriers for use in search planning and could be used to funnel a target to lower country. They also reduce the initial size of the search area. The contours have been checked and the downward slopes identified with red arrows. This may indicate possible directions that a missing person will travel. Using this information it is now possible to contain a search area and divide it into smaller sub search areas for individual searching.

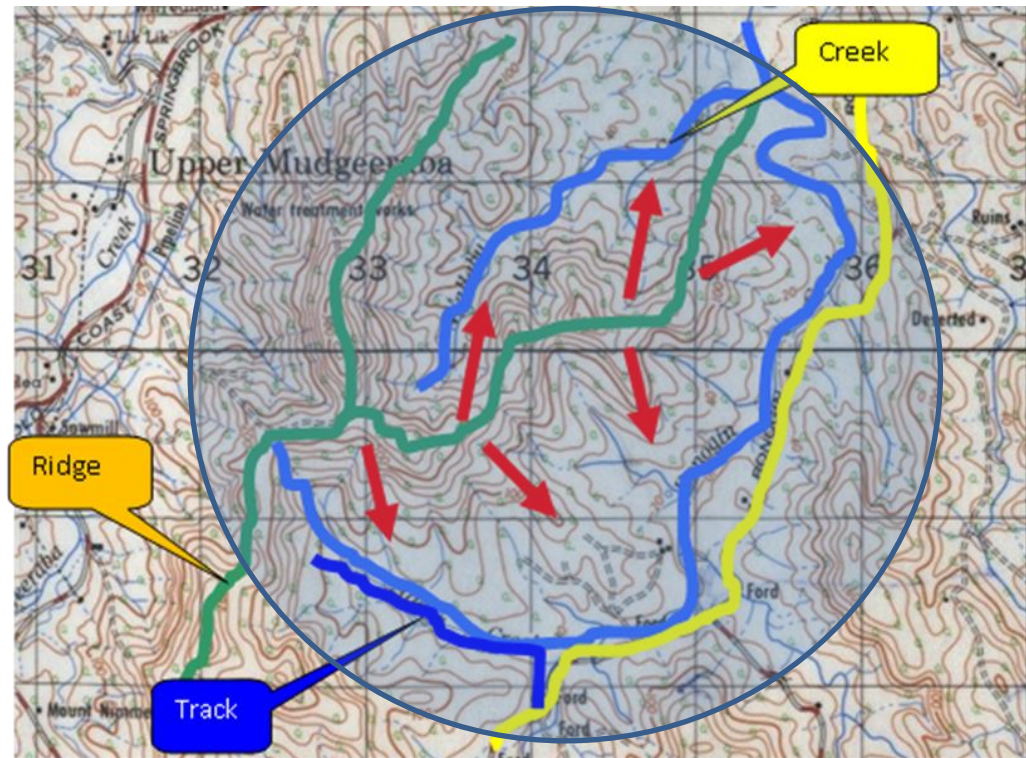

Figure 3-36 Identifying possible barriers in a search area.

- 3.15.4 Once the salient terrain features have been identified it is possible to locate 'paths of least resistance' or 'funnel points' within your search area. The former are routes, normally downhill, that a lost person will subconsciously take while still mobile. Imagine a lost person, tired, demoralised and unable to rationally make a decision, they will naturally gravitate downhill, taking a path that does not offer them any trouble. This path may not be direct and will tend to wander, but always downhill. In these circumstances a barrier search is a worthwhile consideration. Funnel points are exactly as named, locations that tracks, gullies or ridges converge. This has the effect of funnelling persons in a particular direction. Re-entrants are a good example of this. A person lost in a re-entrant will often remain in it, following it downhill, being funnelled to another location. Being able to identify these potential routes will assist in allocating areas to search teams.

Decision Points

- 3.15.5 The diagram below shows what a decision point is. Whether the MP is walking on formed tracks or wilderness they will come across a number of decision points that will require identifying and searching. A decision point is a location where the MP could veer off course or lose the track or bearing entirely. Track junctions are a classic example, with the MP going left instead of right due to a number of reasons such as poor map skills, darkness, inattention and/or fatigue. Other decision points include water crossings, sharp bends in tracks or routes, contouring and elevation changes. The result of poor decision making will leave the MP disorientated.

3.15.6 Examples of decision points are contained below:



Track junction: Track junctions are the classic location for a target to make an error. Poor map reading, inattention, fatigue will all contribute to a wrong track being taken.

3.15.7



Creek junction/crossing: Where a track crosses a creek it is possible for a walker to diverge from the track to the creek without noticing. It is also possible for a walker to take a feeder creek or reentrant and therefore move off their intended track.

3.15.8



Sharp change of direction: Where a track makes a sharp change of direction it is possible for an unwary walker to continue on the original course without noticing.

3.15.9

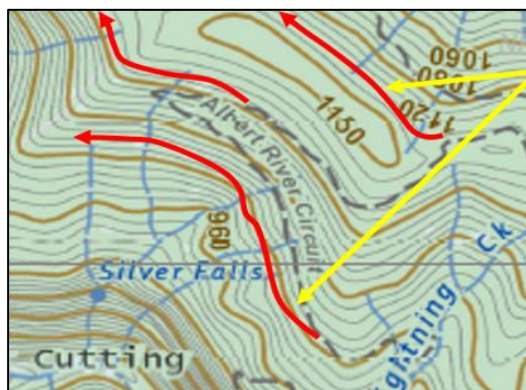

Contouring: Where a track changes elevation it is possible for an unwary walker to continue at the original elevation, losing the track.

3.15.10

Figure 3-37 Decision Points

3.16 Deductive Strategy (Land)

- 3.16.11 This method relies on the SMC looking at all the clues and information provided and making some deductions or assumptions on what the missing person was doing and where they may be. If the MP was an avid photographer then locations for photography may identify areas for a FAST search, similarly if an MP is into abseiling then local abseiling locales will be worth searching.
- 3.16.12 Where the direction of travel of the missing person is known or suspected from sighting, from intentions, or from clues found, the search area may be reduced. However, the missing person may have altered direction intentionally or may not be able to maintain a particular direction. Deductive is not a method to use alone, it must always be corroborated with some other search intelligence.

Using all four Formal Search Strategies

- 3.16.13 It is now possible to utilise all four search planning methods to determine a possible search area, or area of highest probability. For example:
- 3.16.14 **Scenario 1:** It is 0900hrs when the following information is received. A 78yo dementia sufferer has gone missing from her home at 30 Brisbane St, Mt Ommaney. She has no history of going missing before. She has lived at that address for over 30 years but due to illness does not know the address. She has no money or ID and was last seen at 0600hrs wearing a cotton night dress and no shoes inside her residence. She is not a good walker but does not require any walking aides. The weather is a typical winter day, wind 15kph S, 15°C and drizzle.

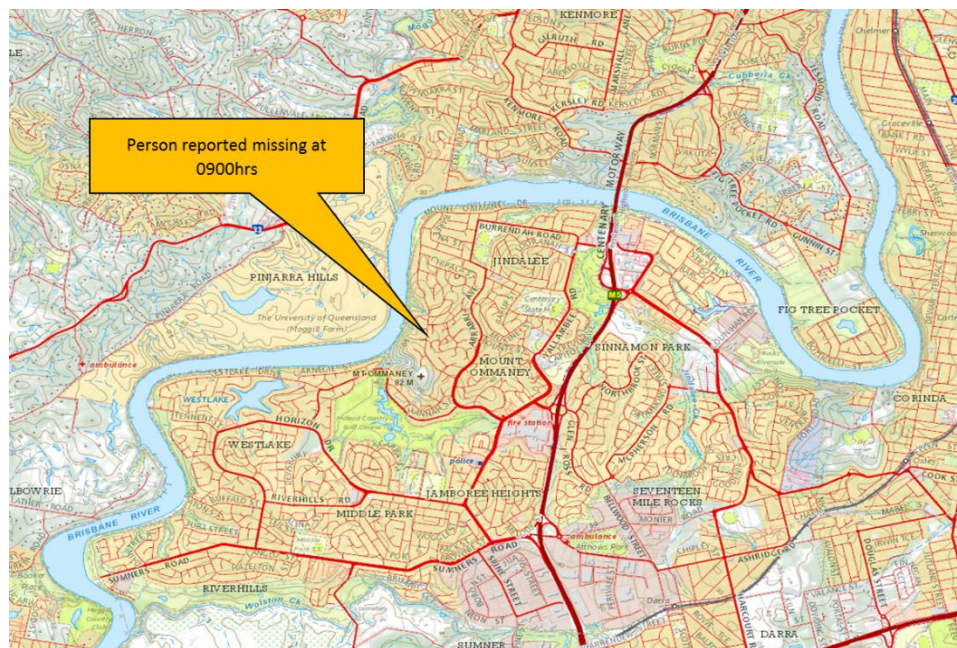

Fi Figure 3-38 LKP of missing person identified.

- 3.16.15 The LKP of missing person is plotted on a suitable map.

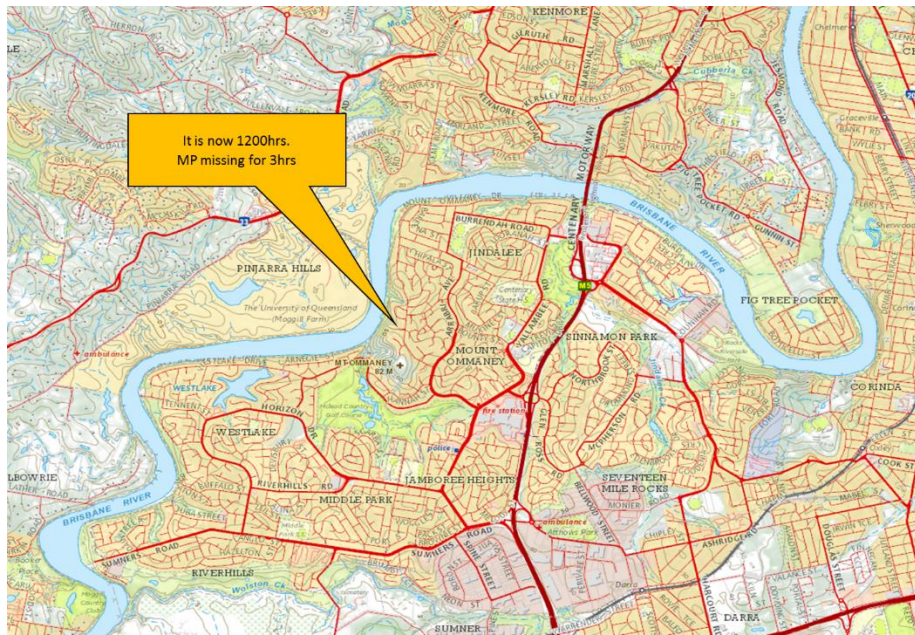

Figure 3-39 Three (3) hours missing

3.16.16 It is now 1200hrs and the MP has been missing for three (3) hours. According to Naismith’s Rule, a person could walk about 5kph in suburban terrain; this rule does not differentiate between ages or ability. A speed of 1.5kph is more reasonable for an MP of this age and condition. Therefore 3 hours x 1.5kph will give a theoretical distance of 4.5km. Draw a circle with a radius of 4.5km around LKP and this will provide the theoretical search area for the MP.

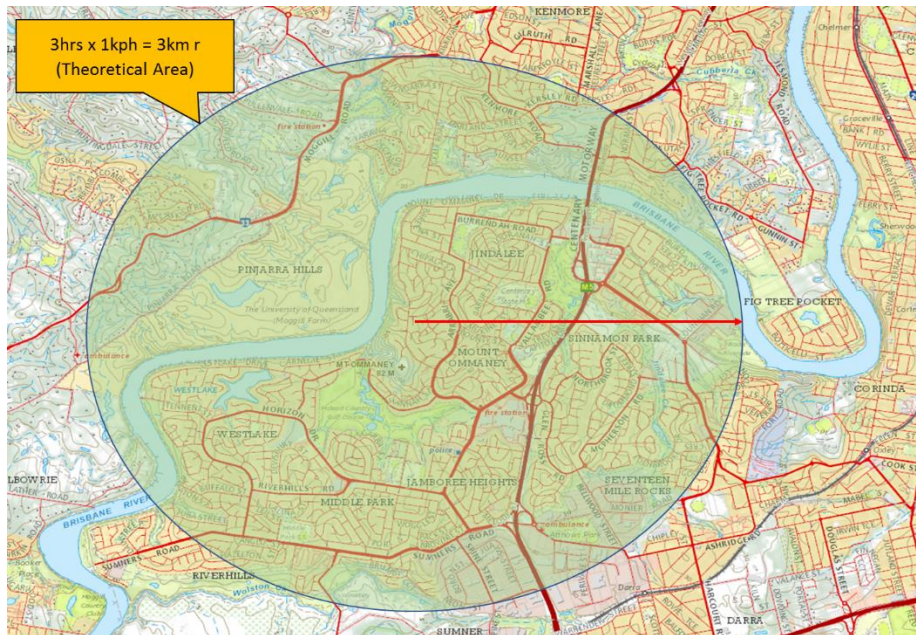

Figure 3-40 Theoretical Area plotted.

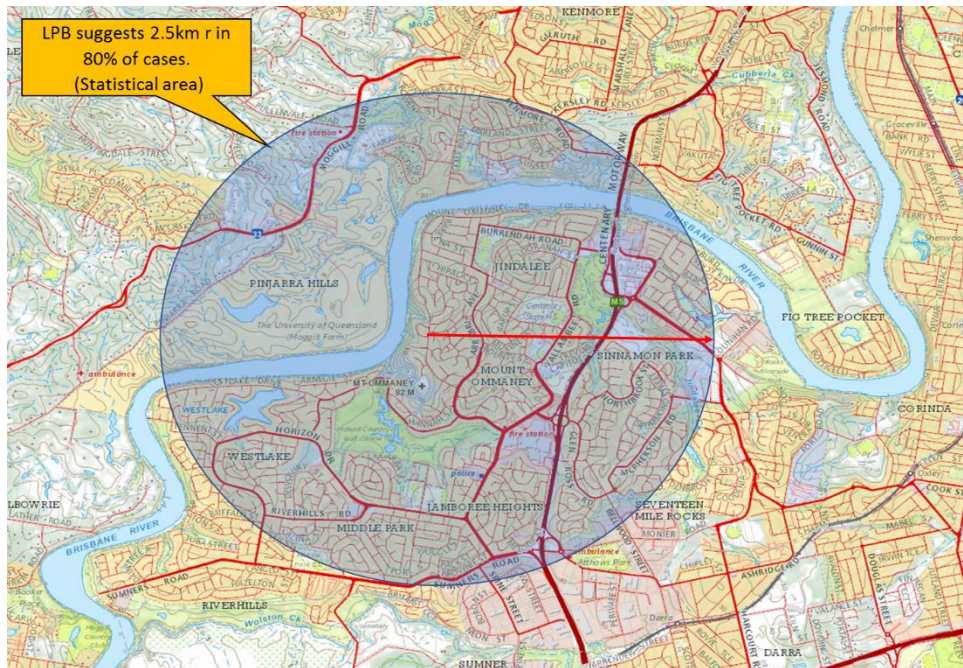

Figure 3-41 Statistical Area plotted.

3.16.17 Lost person behaviour for dementia or Alzheimer suffers suggests that 80% of MP in that category have been located within 3.2km of LKP. Using this information draw a circle of radius 3.2km around LKP. This has reduced our search area by a considerable amount, based on statistics of previous lost people. It is necessary to keep in mind that this is only a statistical measurement and that of the studies there were 20% of MP's who were located outside of this circle. The SMC must devote a portion of their planning to this until intelligence suggests otherwise.

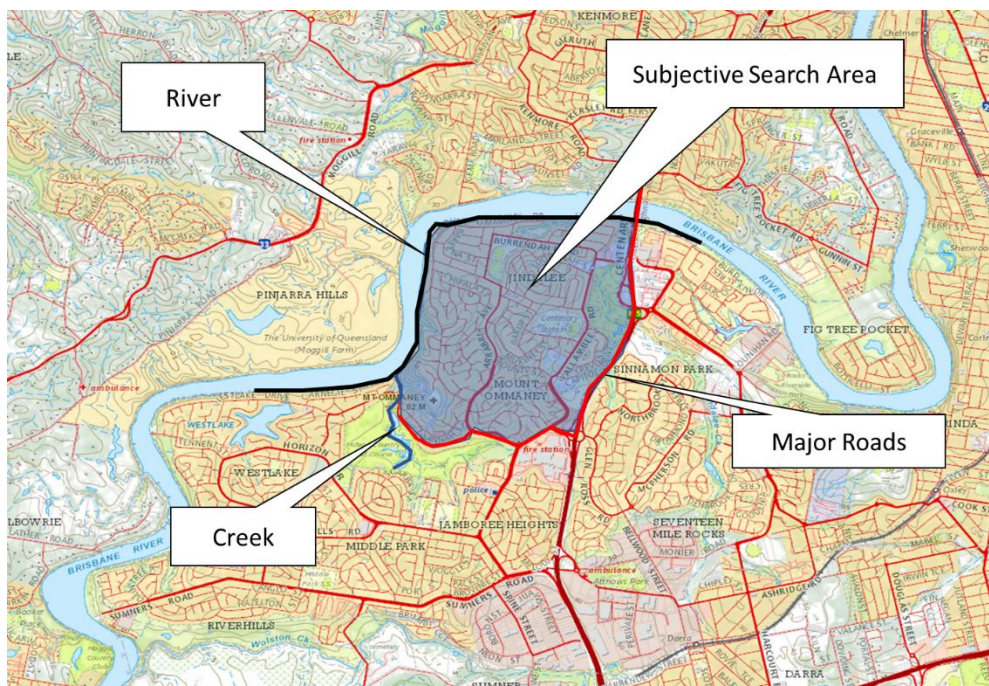

Figure 3-42 Subjective search area plotted.

3.16.18 Use the subjective method and look carefully within the 3.2km circle. A number of defined boundaries can be seen and marked. These will include the Brisbane River, a creek and the Western Motorway. It is a reasonable assumption that a missing person will be contained within these boundaries. They are considerable boundaries and clearly mark the area. It has to be remembered that there will be a small percentage of MP's that will pass through or over any boundaries. Using the above boundaries, it is now possible to reduce further the search area for our MP, in blue above.

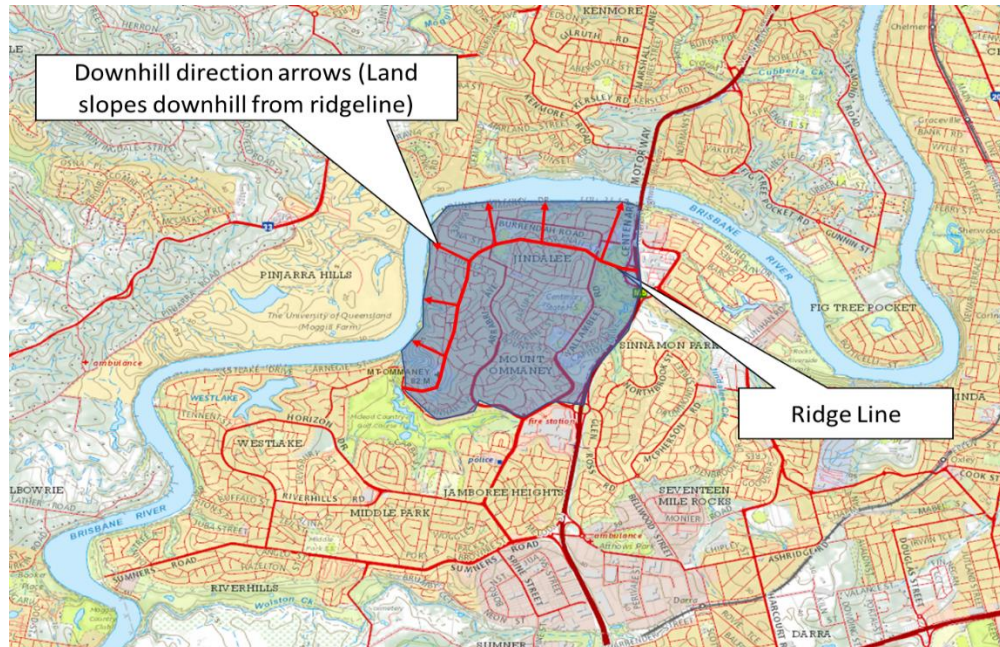

Figure 3-43 Deductive Search Area plotted.

3.16.19 A deductive look at the map will show that there is a ridge, identified in red. The land slopes downward toward the river on the west and north of this ridge. An assumption is that an elderly MP who is experiencing walking difficulties will not walk uphill and will seek the path of least resistance, gradually going downhill towards the river. This assumption should be accurately recorded within your log to justify your search plan.

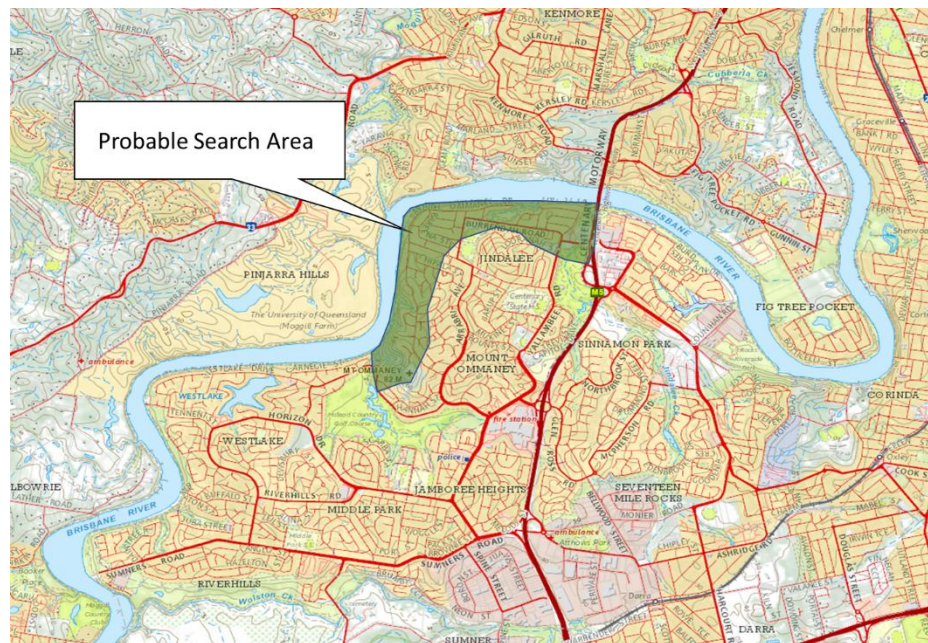

Figure 3-44 Probable search area identified

3.16.20 The most probable search area for the MP is now a small area between the river and the ridge, as shown in green above. Planning can now go ahead to commence a SAR mission.

3.16.21 **Scenario 2:** A bushwalker has been report missing in the Gold Coast Hinterland. She was last seen in the above saddle at 1200hrs after which she became separated from her group. It is now 1500hrs, with three hours having elapsed.

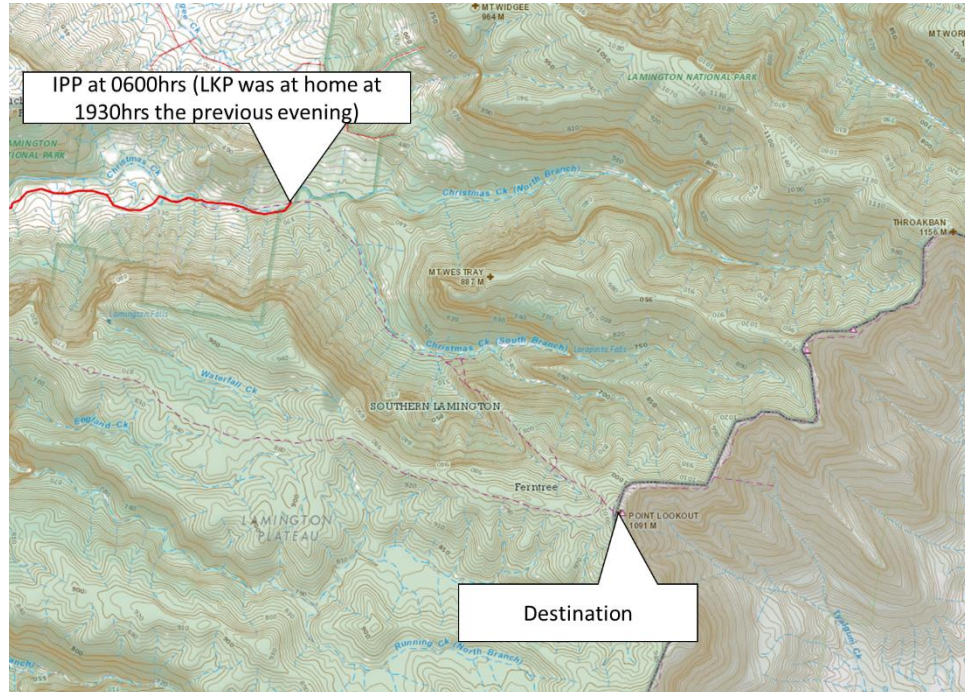
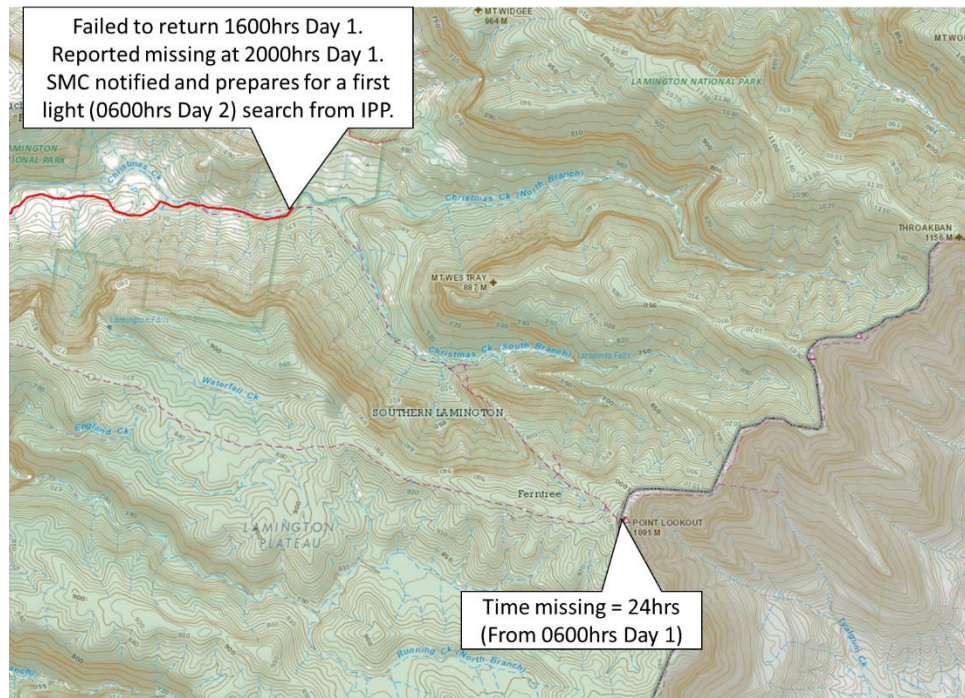
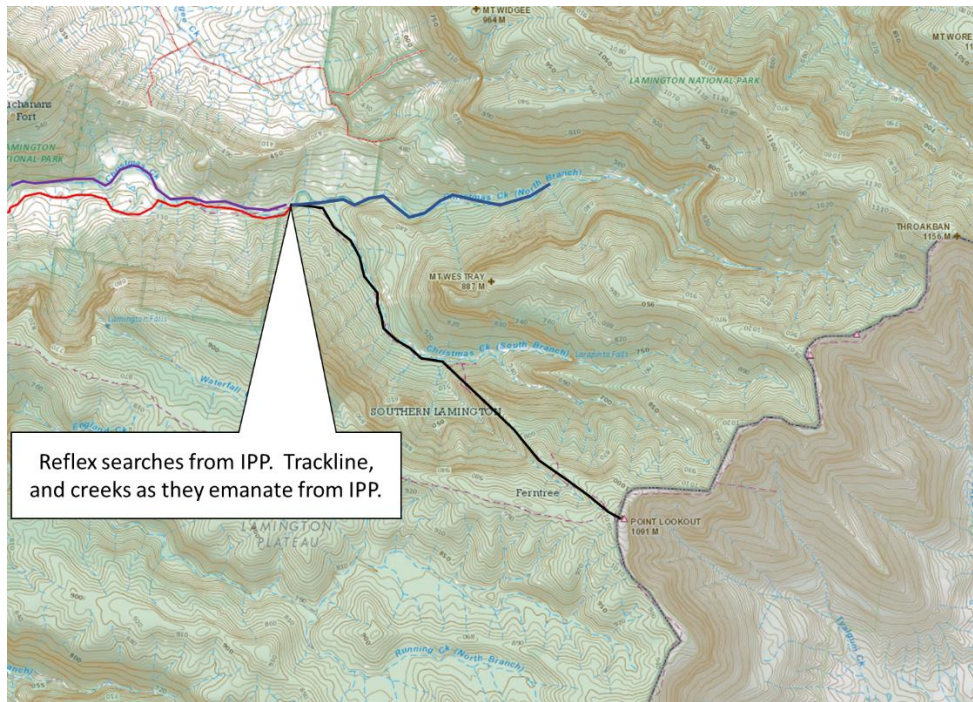

Figure 3-45 LKP of missing bushwalker



3.16.22

Figure 3-46 Working out time missing



3.16.23

Figure 3-47 Reflex search

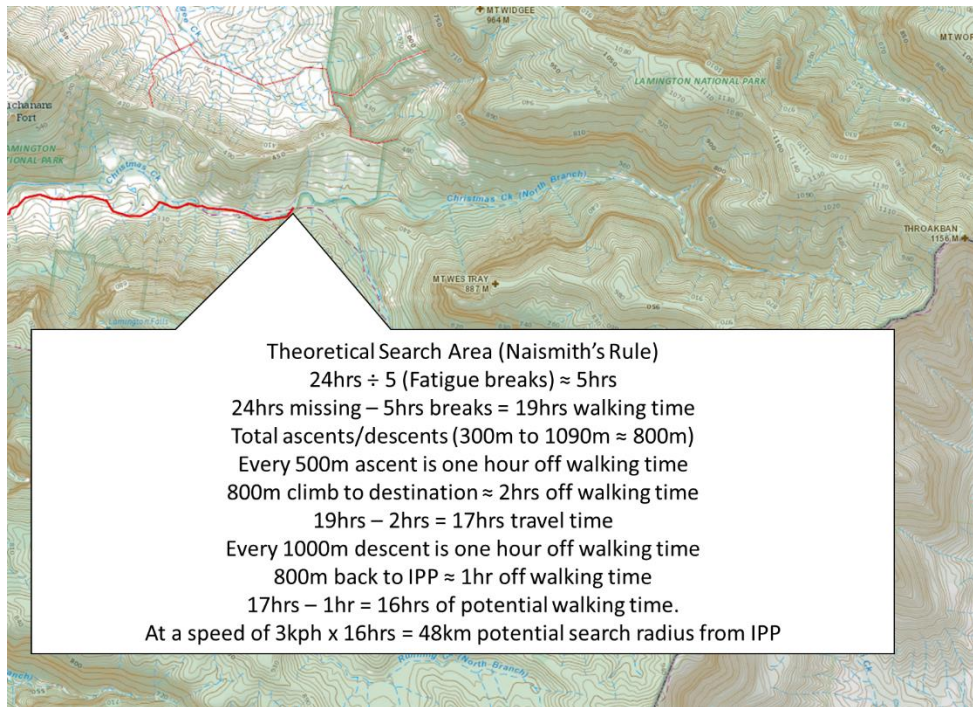

3.16.24

Figure 3-48 The theory of a Theoretical search

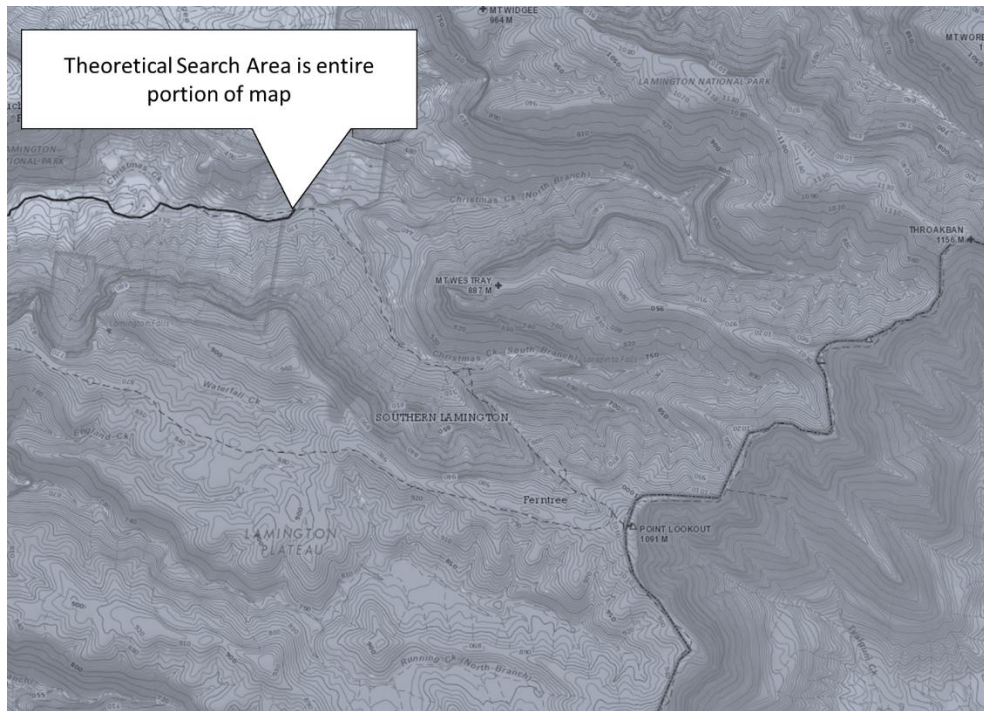

Figure 3-49 Theoretical area is entire map portion.

- 3.16.25 A look at the map shows that the terrain is moderate sloping hills and has open sclerophyll vegetation. Naismith's Rule suggests that a person can walk at 3kph in light wooded terrain, but again does not take into account age or fitness. The MP has been missing for 3 hours and at 3kph, this gives a circle with a radius of 9km. This area covers the entire area of the above map.
- 3.16.26 Statistically, the lost person behaviour for hikers shows that 80% are normally located within 5.76km of LKP. After drawing a circle of 5.76km radius from LKP it can be seen that it still covers the entire section of the above map. In the above instance this has not tightened the search area by much.

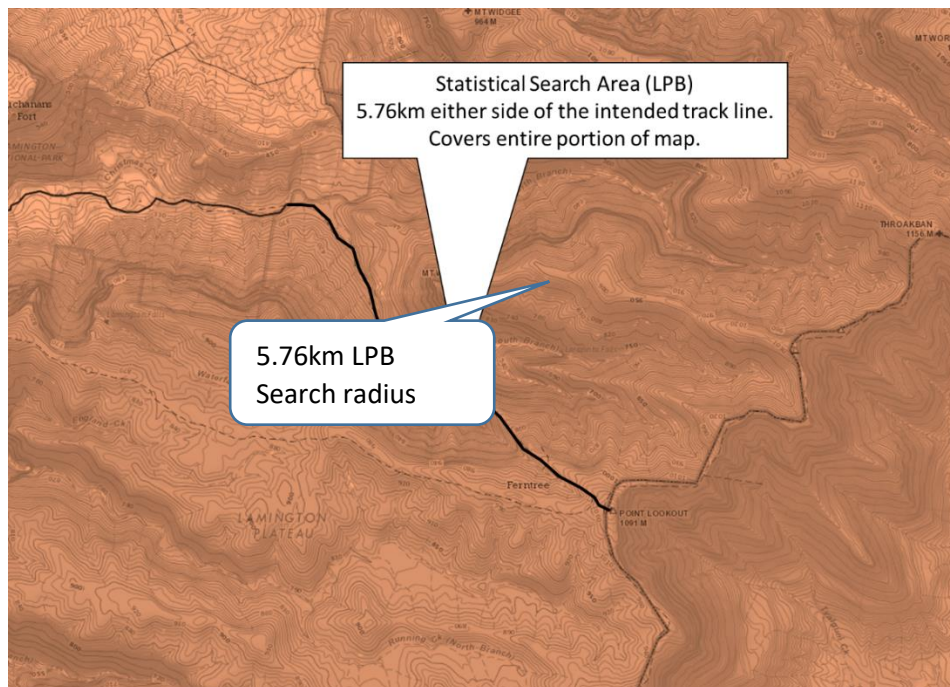

Figure 3-50 Statistical area is also entire portion of map

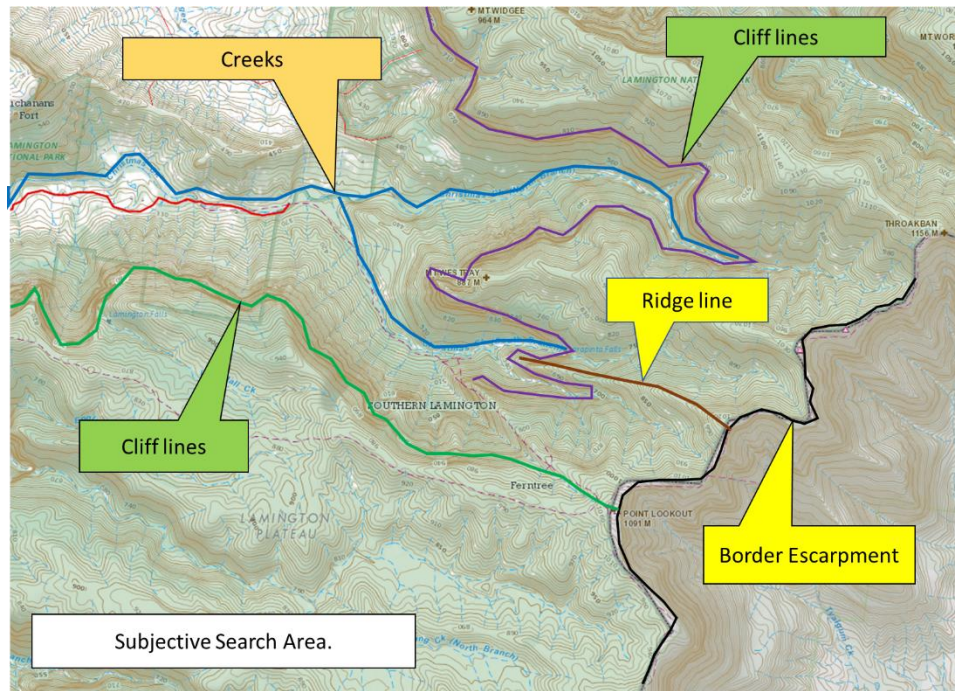
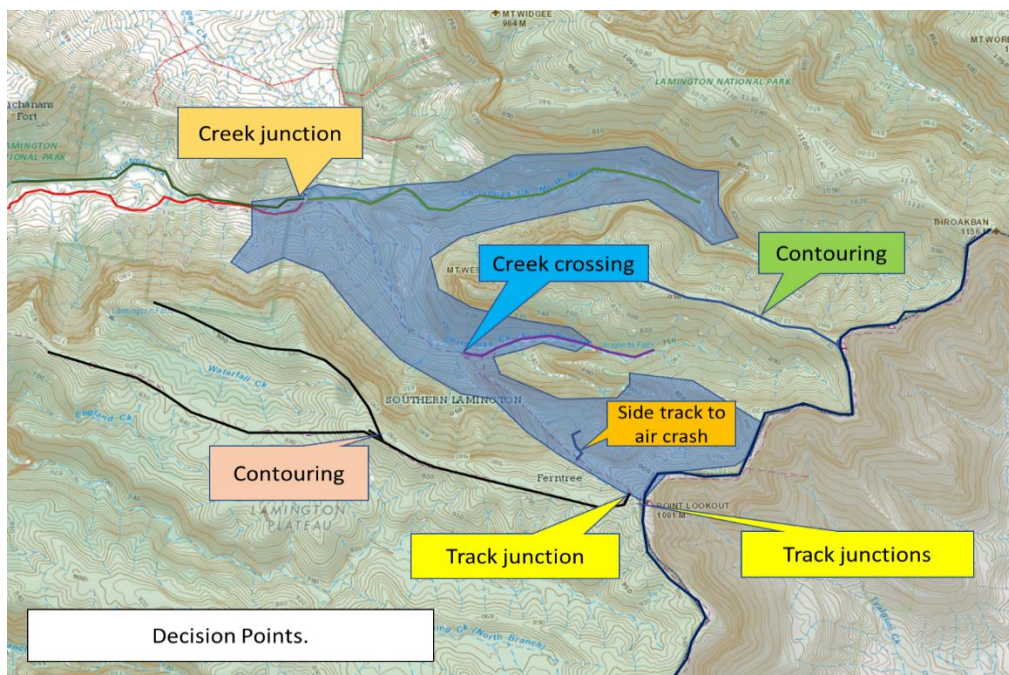

Figure 3-51 Subjective features plotted

3.16.27 Looking subjectively at the map a number of natural and manmade boundaries can be identified, including the road, creek, ridge line, re-entrant and tracks. Marking these will reveal an irregular shaped search area, shown in green above. An inspection of the terrain has also identified that from the LKP the land slopes downward towards the creeks on both sides of the ridge. An assumption could be made that a missing person would walk downhill towards a watercourse and then follow it to help. An equally valid assumption could be that a missing person would seek higher ground to attempt to identify their location. Which course the missing person will take will depend on their experience, ability to navigate, mental state and fitness. Intelligence gathered during pre and ex comms may shed light on this assumption. In either instance the area contained within the identified boundaries would be the area of highest probability.



3.16.28

Figure 3-52 Decision Points identified

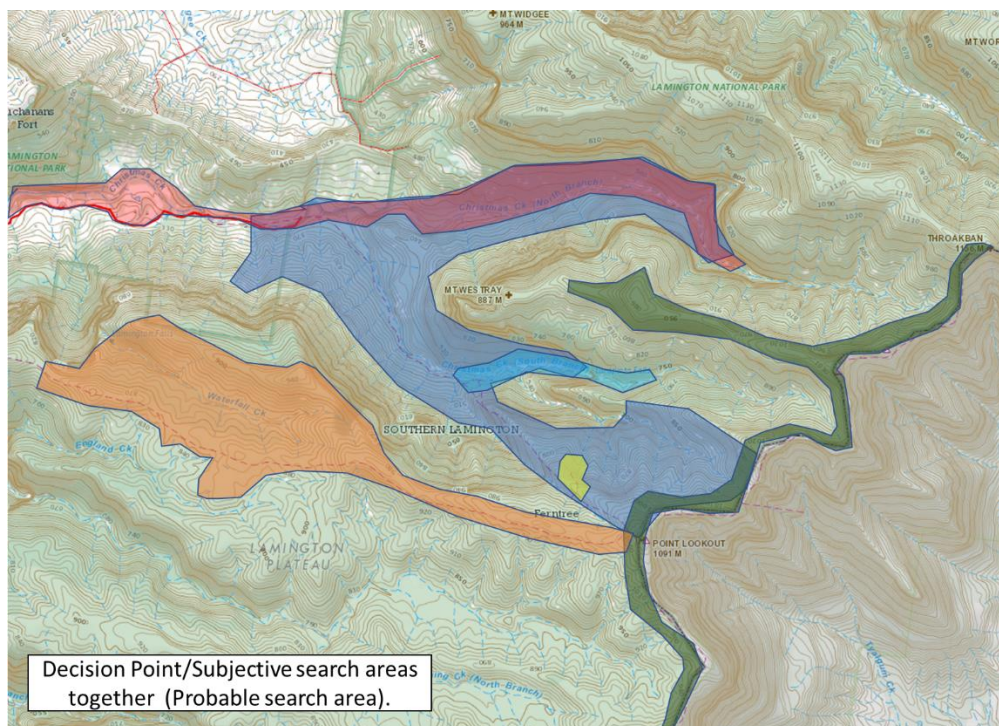

Figure 3-53 Probable search area plotted

- 3.16.29 Search Area Segmentation: It is now essential that the search area be segmented into task areas. These should be small enough for efficient coverage by a team in a reasonable time. Where segmentation results in more task areas than teams, it is necessary to prioritise the task areas. Where specialist skills are required to search an area, e.g., mine shafts, sink holes or cliffs, these should be treated as specific task areas. Segmentation into task areas on a map may not easily translate into identifiable blocks on the ground. It may be necessary to modify task areas to suit the ground conditions. The boundaries of task areas should be readily-identifiable features such as:
- a) Natural features (e.g., rivers, creeks, ridges, re-entrants, spurs, tree and grass lines, and shorelines); and
 - b) Artificial features (e.g., roads, tracks, power lines, water pipelines, fences, railway lines etc.).
- 3.16.30 Where readily-identifiable features are not available as task boundaries, use may be made of global positioning systems (GPS), compass bearings or markers.
- 3.16.31 In some environments there will be no natural barriers within your possible search area. This often occurs in the inland areas of all states except Tasmania, where there are large tracts of open plains with no watercourses, hills or other obstacles, but can also happen in large rainforest areas or sclerophyll forests. In these cases it is not possible to reduce the search area by these means and it is necessary to look elsewhere for clues and assistance.

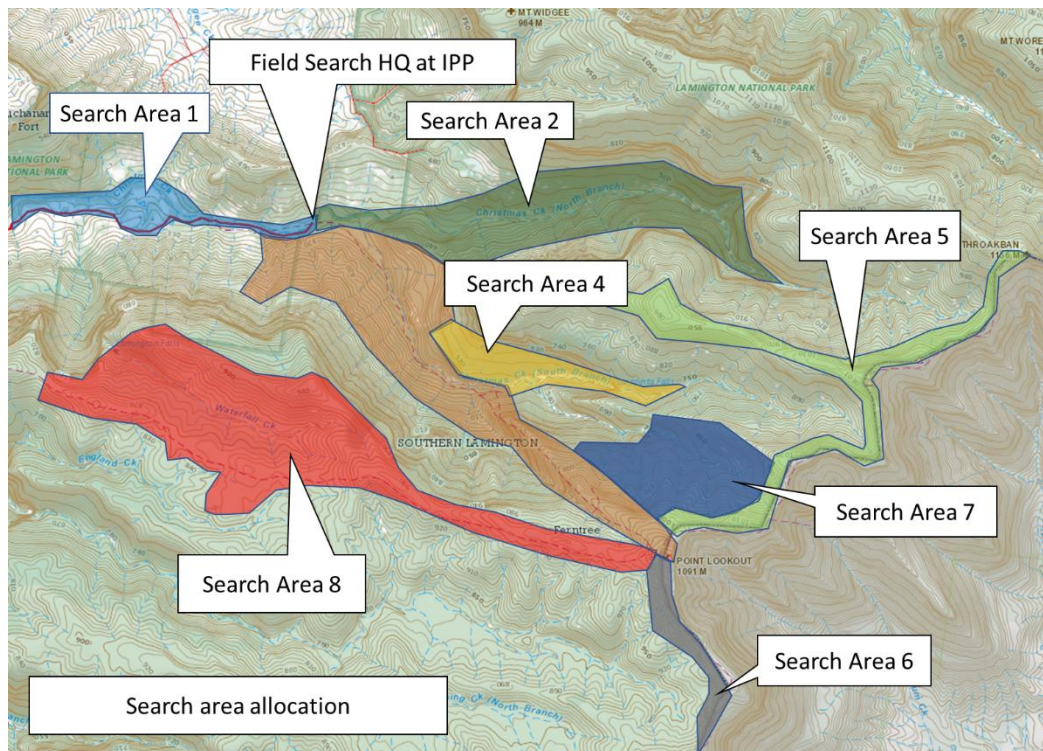

Figure 3-54 Search area divided into smaller searchable areas.

3.16.32 The intention of the MP can be a pointer to possible directions of travel. The fall of the land may suggest natural funnels, which will draw a missing person. Lost and tired persons tend to walk down hill, following the path of least resistance where possible. Cattle and animal tracks will often be followed by lost persons.

3.17 Recording of search areas (Land)

- 3.17.1 Once a search area has been determined it is necessary to keep a permanent record for future reference and as the basis for sub-search areas.
- 3.17.2 **Overlays:** The actual search areas are not recorded directly on the map. If this is done the map is then unable to be used for further searches within that incident or for other incidents. In the event the missing person/vessel/vehicle or aircraft is not found this map then becomes evidence and may never be used again. Acetate sheet or tracing paper have been traditionally used to record search areas. In doing so it allows the map to be used for other parts of the search and for future searches.
- 3.17.3 Each overlay should represent a part of the search. Overlays can represent:
- The entire search if resolved in a short period of time
 - The search area for one day
 - The search area for one period of time such as AM or PM
 - The search area for individual search teams.
- 3.17.4 Each overlay should have the date, name and number of the map and the SMC's recorded in a top corner. The overlay should also have at least two cross hairs (+) at diagonal locations marked with the four figure grid reference to enable the overlay to be replaced in the correct location on the map in the future.
- 3.17.5 At the end of each search the individual search area recorded on the overlay can be hatched out (#) in red to show that that area has been search. This should correspond with the completed task sheet for that search.

- 3.17.6 At the end of each search day all overlays should be collected. By superimposing them the SMC will be able to see which areas have not been searched and which will need researching.
- 3.17.7 At the end of the search, the overlays will provide a detailed day by day representation of the search activities and search development.



3.17.8

Figure 3-55 Identify search location.

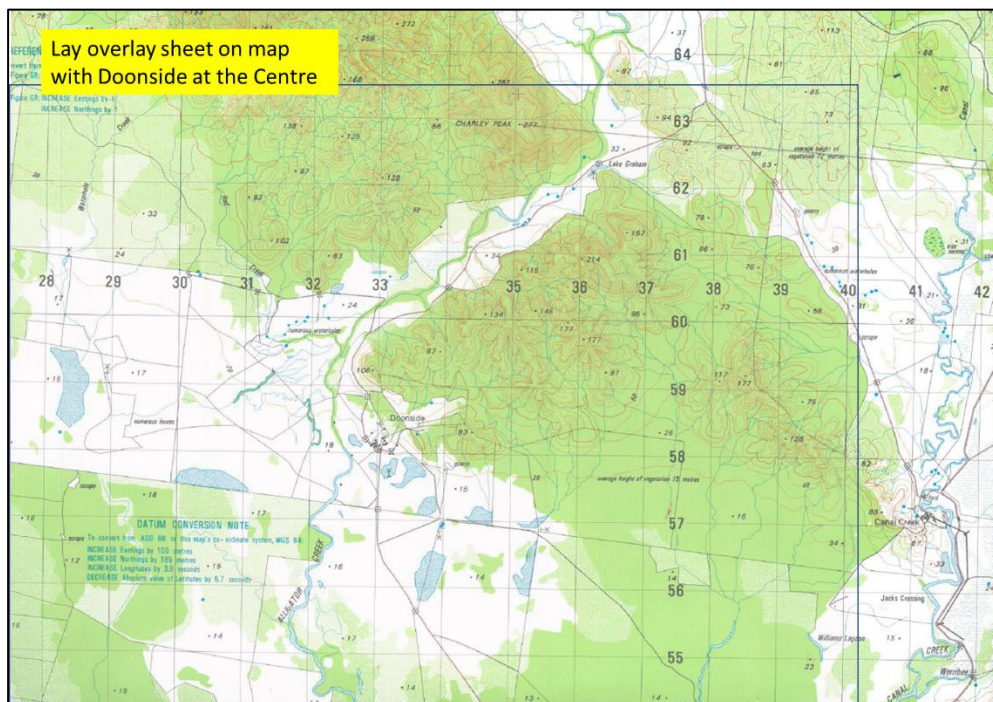

3.17.9

Figure 3-56 Place overlay sheet on map, location in centre.

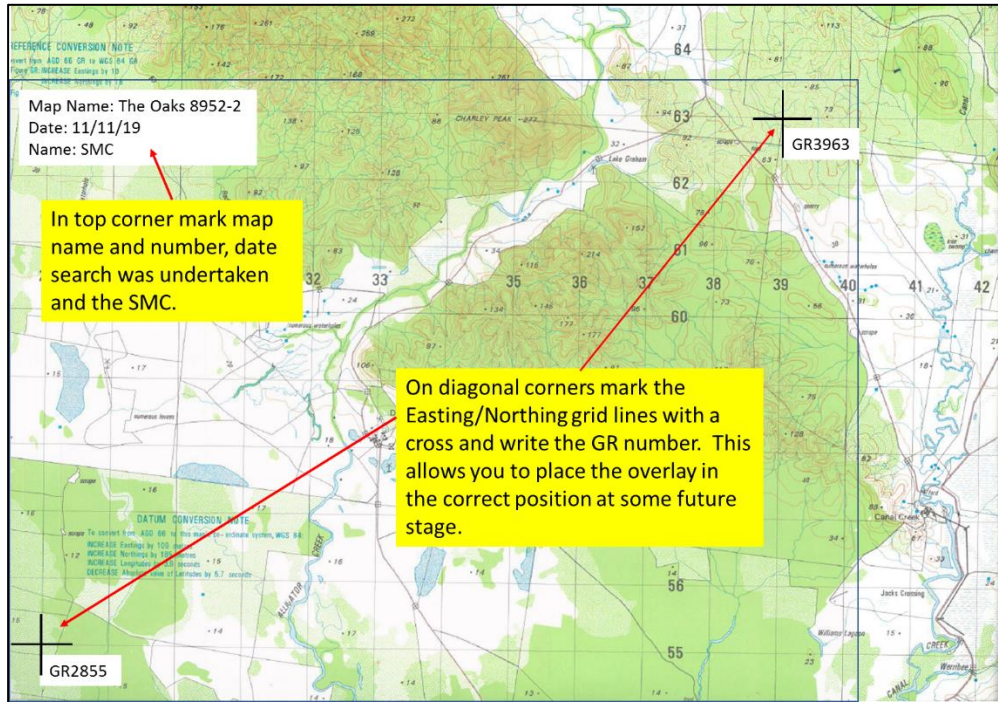

3.17.10

Figure 3-57 Mark two grid line intersections, Map name, SMC and date.

3.17.11

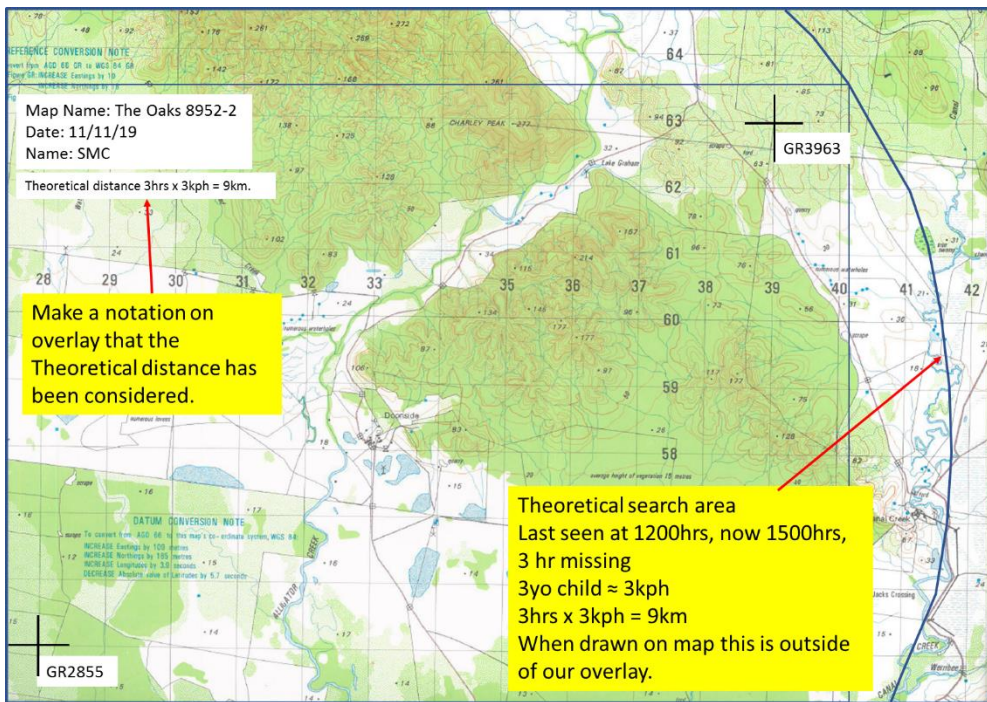

3.17.12

Figure 3-58 Theoretical search area marked.

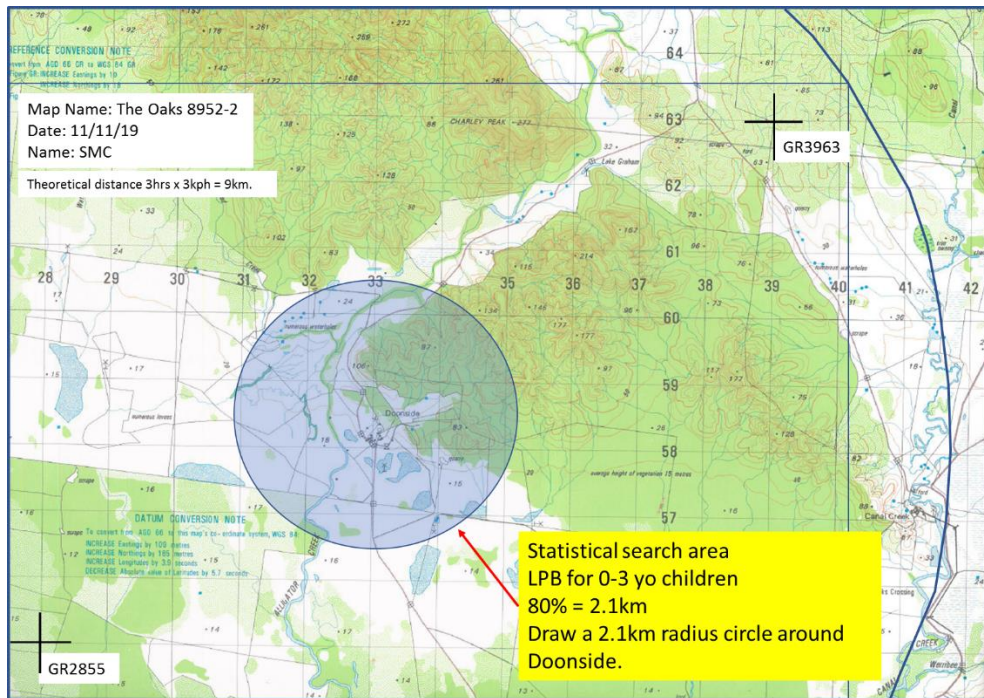

3.17.13

Figure 3-59 Statistical search area marked.

3.17.14

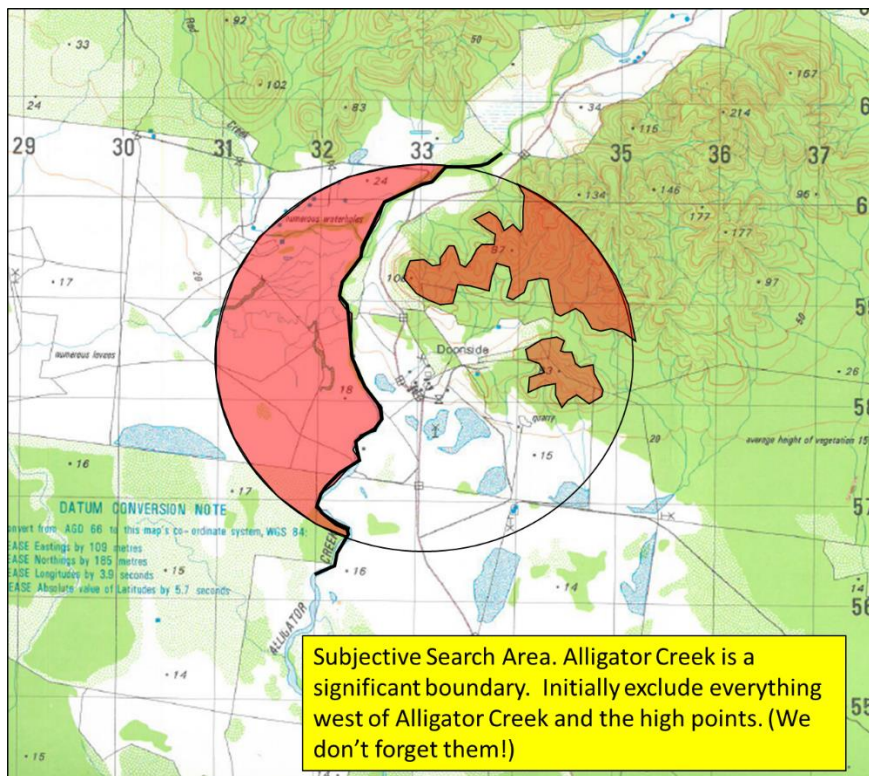

3.17.15

Figure 3-60 First stage of Subjective analysis.

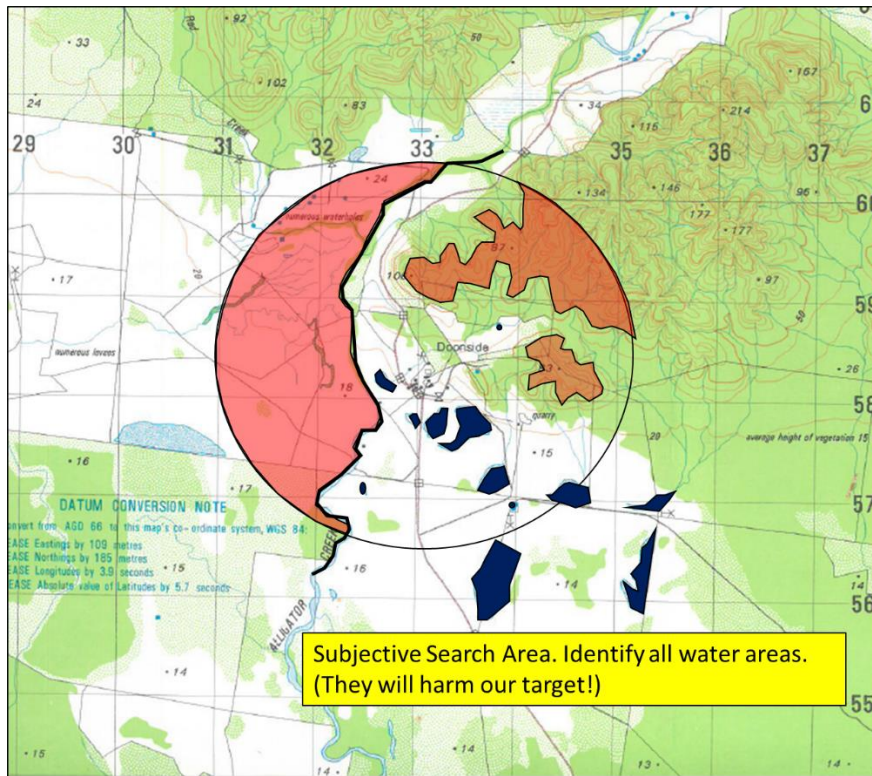

3.17.16

Figure 3-61 Continual Subjective analysis

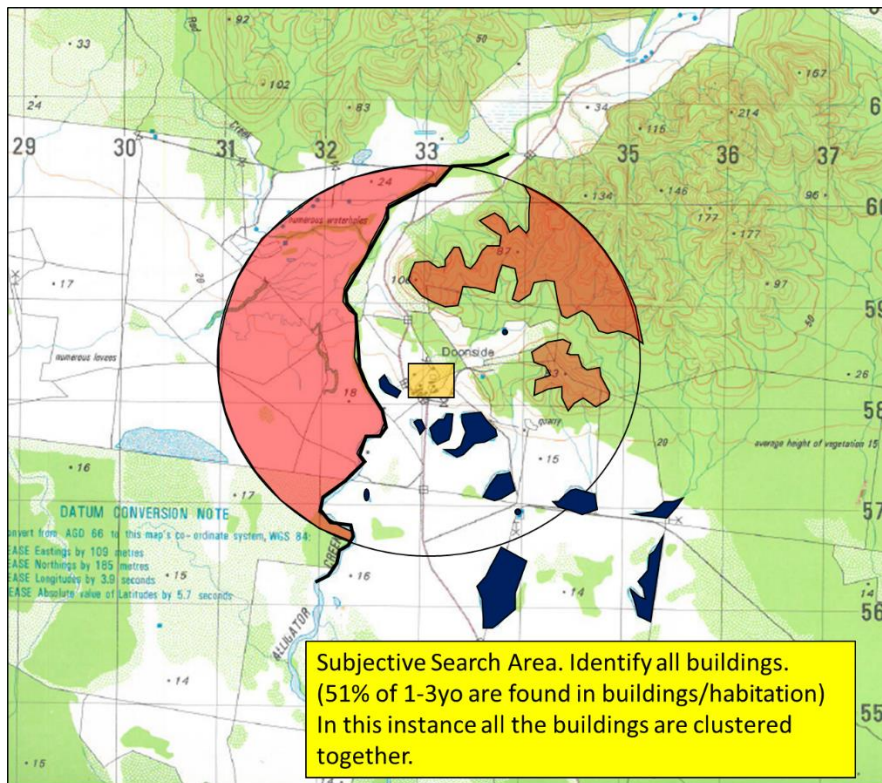

3.17.17

Figure 3-62 Continual Subjective analysis (Buildings)

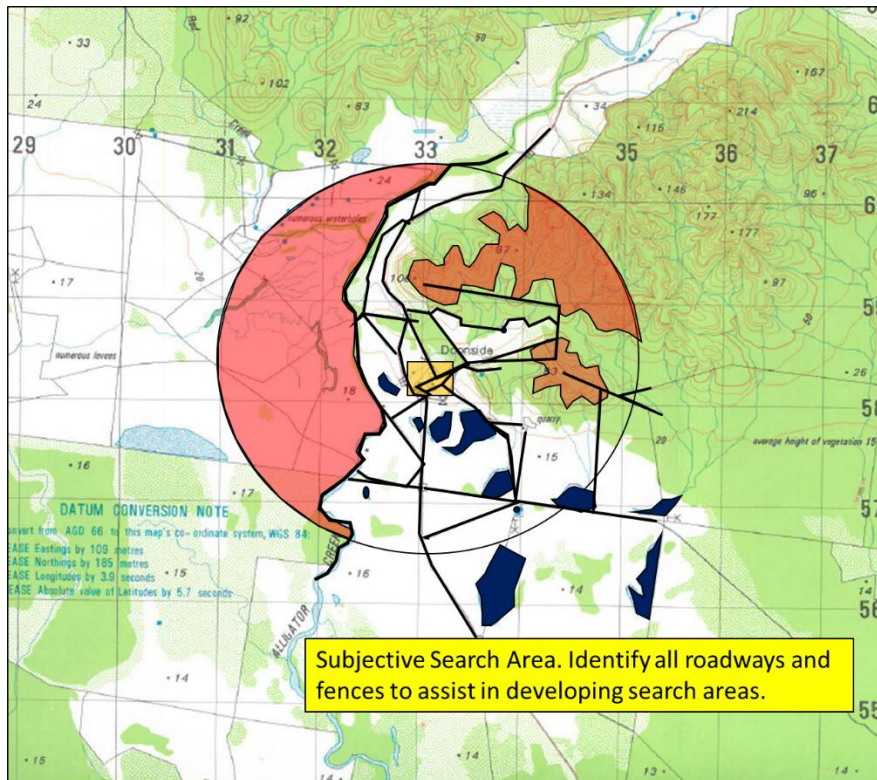

3.17.18

Figure 3-63 Continual Subjective analysis (Fences and roads)

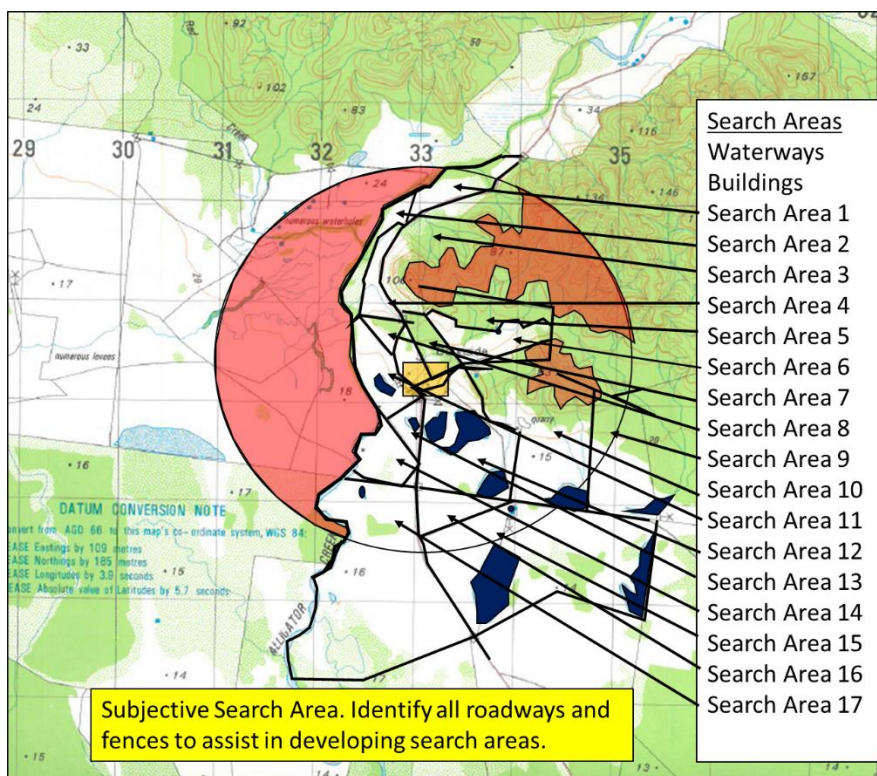

3.17.19

Figure 3-64 Search area allocation



3.17.20

Figure 3-65 Deductive search analysis.

- 3.17.21 **Electronic Recording of search areas:** Recently there have been advances in electronic recording of search areas. The methodology is the same as for overlays, just done on a computerised map. Mapping software, such as Google Earth, allows search areas to be marked and assigned to individual search teams. As would be done with overlays, the search areas determined electronically need to be saved as per operating instructions. Search teams can be assigned to areas and details recorded. Completed searches can be hatched (#) out on the electronic map providing a ready reference for those areas being searched, those to be searched and those that have been completed.
- 3.17.22 At the end of each period, day and search the electronic search areas will be saved for reproduction at a later date.
- 3.17.23 Items of interest can be recorded directly onto an electronic map, with attachments such as photographs, commentary and situational factors.
- 3.17.24 Electronic search mapping also has the benefit that it can be electronically sent to distal search teams, used for briefings and displayed on screens at a number of locations simultaneously.
- 3.17.25 **Downloading and storing GPS Data:** For the purposes of standardising the downloading and storage of SAR related GPS data, such as search asset tracks, the following guidelines are to be followed to ensure that data security is maintained.
- Where possible, only data from SAR Authority owned GPS receivers is to be used.
 - GPS receivers are to be downloaded in accordance with manufacturer's instructions.
 - GPS data is to be downloaded from search assets on a daily basis to ensure it is not overwritten or otherwise lost.
 - The GPS data is to be overlaid onto a mapping program such as Google earth or OziExplorer.

-
- e) The original downloaded track overlay is to be immediately saved. Any subsequent changes to the overlay, such as shading; other search areas or briefings are to be done on a copy and subsequently saved.
 - f) At the conclusion of the SAR incident, or daily, if possible, GPS downloads are to be saved in the electronic SAR occurrence.
 - g) If evidence of the provenance and integrity of GPS receivers is required in a Coronial matter the SMC will provide a statement testifying to its integrity or use a method under each state/territory Evidence Act.

Behaviour of Lost People

Specific factors of LPB that may affect search planning:

- 3.17.26 State of Health: The physical health of the lost person will have a direct impact on their ability to self-help and formulate rational decisions. Recent illnesses, poor fitness, disease, lack of adequate nutrition and lack of sleep will restrict a person's ability to cope with situations such as being lost in an unfamiliar environment. Increased physical stress will result in fatigue and exhaustion setting in, reducing the ability to think clearly. Good physical health may be an indication of an ability to withstand the rigors of being lost.
- 3.17.27 Past Experiences: Studies have shown that persons who often challenge themselves in new ways or expand their comfort zones will be more adaptable to adverse situations, such as being lost. Gathering evidence of past experiences will provide an insight as to the missing person's ability to cope with challenging or stressful situations. A person who rarely does or tries anything new is more likely to be helpless and a liability when lost.
- 3.17.28 Physiological effects of the environment: While it is acknowledged that extremes of heat and cold will have a detrimental effect on a missing person, a combination of normal temperatures with rain and/or wind will quickly have adverse effects on a missing person. Wind and wet chill can quickly lower the core body temperature, and will cause a person to seek shelter which will limit their detectability by searchers. Hypothermia has been identified as a leading cause in death and accidents in the outdoors from a search and rescue perspective. Persons suffering from either hypothermia or hyperthermia become irrational and lose the ability to help themselves. Altitude exacerbates any effects of these debilitating conditions.
- 3.17.29 Fear Factors
 - a) An aspect that is often overlooked with respect to missing persons is general fear. Fear can be categorised as five basic types; fear of being alone, fear of the dark, fear of animals, fear of suffering and fear of death. A SMC must take these fears into account when planning a SAR mission, not just from a lost person point of view but also from a searcher viewpoint.
 - b) Fear of being alone: In Australia this could also be termed fear of the bush. While some people choose the isolation of the bush the average person finds it haunting. The bush, and this term covers everything from the central deserts, coastal rain forests, snowy alps, eucalypt, brigalow and gidyea forests and northern swamps, is a very harsh and difficult place to survive adequately. Most of the continent has very little surface water and native foods are difficult to safely identify.
 - c) Fear of the dark: Most humans have a primeval fear of the dark. This coupled with the noisy nocturnal activities of most native animals makes the bush darkness a stressful place to be. Compounding this is the general loss of our most important sense, sight. Without being able to see objects in the darkness our imagination can often conjure up images that can cause the strongest to be afraid. This sensation is not confined to lost persons, as it also has an effect on searchers. Those searchers on the extremes of any line search will eventually creep closer to the centre because of this fear of the dark, hence a 100m wide search initially will eventually diminish to cover a much smaller area. It is amazing how a small amount of light, from a torch or fire, can alleviate this fear.

-
- d) Fear of animals: Although Australia has no known predatory animals that actively prey on humans there is an irrational fear of being in the bush alone. Most native animals are nocturnal, and their nightly activity can unnerve people and preclude a good night sleep, with the associated reduction in rational thinking and self-help ability.
 - e) Fear of suffering: The spectre of survival can cause an often rational fear of suffering in lost persons. Australia is an extremely harsh continent, not designed to support lost persons. The possibility of dehydration, starvation, hypo- and hyperthermia, illness and injury are all real possibilities, and there are many examples of each throughout our history. The thought of the lingering agony of each situation can create a very real fear among some lost persons.
 - f) Fear of death: The fear of a lingering death can haunt many people, particularly when they consider the many things yet to do; leaving loved ones behind, tying up loose ends and the hereafter. In some instances, the fear of death can actually hasten it.

3.17.30 Biological Cycles

- a) These cycles have been recognised in the medical world for many years and do have some application to search and rescue. Most humans go through a cycle of highs and lows which can vary from periods as short as a day to periods of months.
- b) Female biological cycles are relatively easy to map and generally fall in line with their menstruation cycle.
- c) Males have similar but less detectable cycles. Studies have shown that males will generally mirror their female partner's cycles.
- d) A person at the high point of a cycle may see being lost as a challenge to be met head on. These people will attempt to self-help and have a greater chance of survival in adverse conditions. Conversely, a person at a low point of a cycle may have little energy to assist themselves and may succumb to conditions more quickly.

3.17.31 Behaviour while Lost

- a) The recognition of being lost occurs at different stages for people. It may be the slow awareness that it is taking far longer to reach a destination than was calculated or the instant realisation that what was once familiar territory is now not. A lost person can go one of two ways; sit tight and quietly reflect the situation and work out a solution or to hasten their pace as the destination 'could just be over the next hill'. This second situation can then also go in two directions; the realisation that they are getting further into unknown territory and sit down to reflect the situation or to increase their pace and run to avoid the fear of the bush, which now appears to be closing in around them. In other words they are panicking.
- b) Those persons who take the time to ponder may identify their location and self-help to safety. If this is not possible they will often form a shelter and wait for rescue.
- c) Those who are compelled to continue in a blind rush often find themselves injured in locations often far removed from their original intended track and therefore take longer to locate and rescue. It is worth considering that these people may often attempt to travel up hill to either locate a path or orientate themselves to their environment before fatigue, despair and/or depression takes over and they tend downwards on the path of least resistance. These people will often take risks beyond their capability and as a result suffer more injuries than would normally be expected.
- d) In both the above circumstances shock will be suffered by the lost person. This will manifest itself in many different ways depending on the person's mental strength, from simply forgetting incidents that have occurred to failing to seek shelter from rain or snow.

3.17.32 The trauma of being lost may also have the following effects on a lost person:

- a) Not seeking shelter. Many persons do not make an adequate shelter nor build a fire for warmth. With hypothermia and hyperthermia being very prevalent, particularly in desert,

mountainous and urban areas, this is a vital necessity and will extend a person's chances of survival. Survivor questioning has often elicited the assumption that it is not worth the effort of making a shelter even if it will limit heat loss and provide a measure of mental comfort.

- b) **Discarding equipment:** Many persons discard their equipment without thought for using it to survive. While it is true that most lost persons are not prepared for the conditions as they only expected to be out for a few hours, there have been many instances of people being extremely well prepared and failing to use the items that had with them, particularly tents and fire making apparatus. Discarding clothing and backpacks is common and may be contributed to the shock of being lost.
- c) **Discarding clothing:** Many persons discard their clothing while wandering in the bush. This may be because of overheating in warm areas, but soon becomes regrettable as the sun sets and the temperature cools down. While understandable in hotter areas it also happens during the early stages of hypothermia in colder areas. The net benefit of discarding clothing is that the lost person succumbs sooner.
- d) **Sense of abandonment:** Often with the shock of being lost is the sense of abandonment, the feeling that nobody is looking for them. Throughout Australia a search mission will be commenced once the alarm has been raised by a concerned party. If the SMC has an itinerary and LKP then the task of locating the MP is much easier. If there is no itinerary, no LKP and the MP has not been seen for some time then the task is that much harder.
- e) **Clothing:** Self-helping and responsiveness is a big factor in determining what type of search to opt for. A MP wearing bright clothing and actively seeking assistance will be easily located when compared to a small child dressed in dark clothing hiding in the undergrowth for shelter. Children are often taught 'stranger danger' and are reluctant to approach a stranger in these circumstances. MP suffering shock or other mental issues may make no attempt to draw attention to themselves even if they see a searcher, motor vehicle or helicopter.
- f) **Navigation aids:** Ignoring aids such as tracks, paths and fences is a common problem associated with MP's suffering shock. Common sense dictates that if a MP locates one of the above it will lead to a main road, gate or house where help can be obtained. On many occasions a MP will cross a track, path or fence, often without realising it, only to be further lost in an area outside a high probability search area.

Mass Casualty SAR Incidents

3.17.33 **Causal factors:** Throughout the world manmade or natural disasters regularly overwhelm small communities with the resulting loss of live and missing persons. These causal factors include:

- a) **Mud slides:** 'A mass of mud and other earthy material that is falling or has fallen down a hillside or other slope.' Mudslides are very common in the wetter parts of the world, northern South America, central Africa and south-east Asia as a result of large amounts of localised rain which causes a portion of surrounding hills to shift downwards, wiping out small villages and destroying communities. Statistical evidence suggests that most people caught in the mudslide will either self-recover or make it to safe ground or they will not. There is very little evidence that people survive for any length of time in mudslides. Missing persons swept up in the mud will be taken some distance from where they began, possibly being pushed to the side of the mud flow or buried deep within the flow.
- b) **Tsunamis:** A long sea wave caused by an earthquake or other underwater disturbance. Tsunamis are more common in the Pacific Ocean, primarily because this ocean is surrounded by moving tectonic plates. While not common, tsunamis are not all that rare and occur on a semi regular basis with little effect on the surrounding countries due to the distances involved and depth of the ocean. In recent times they have involved several waves or walls of water surging inshore for distances up to ten and twelve kilometres depending on the topography of the ground. The waves or wall of water may be only a few

centimetres up to four and five metres in height. The water gathers up all loose items in the way, and it is these that often cause the damage to structures and persons. The initial force of the water and the amount of debris are what prove fatal to people caught in the first or subsequent waves. Similar to mud, people swept up in the tsunami will often be taken some distance from where they first entered the water. These people may be deposited far inland or carried back out to sea as the wave recedes. In both instances survival would depend on their ability to get out of the way of the water. Once trapped in the water chances of survival quickly fall.

- c) **Flash flooding:** A sudden local flood of great volume and short duration. Flash flooding is different to general flooding in which the community normally has some prior knowledge. Flash flooding can occur as a result of a sudden downpour of rain in a localised area or as a result of heavy rainfall in another location flooding into a second area. There is generally little prior knowledge or warning of a flash flood. General information suggests that those persons trapped in the flood waters have a limited chance of survival unless they manage to extricate themselves within the first few minutes. The longer the period trapped in the water, the less likely they will survive due to the buffeting and collision with water borne debris and other obstacles including vehicles, trees and ground fixtures.
- d) **Bush fire:** A fire that occurs in the bush, started by lightning, burn off or deliberately. Australia is plagued by bushfires, particularly during the hotter months of the year. They can be limited to a single property or cover vast tracts of land driven by favourable winds. There is no large scale effective countermeasure against bushfires except burning off the ground fuel before the fire front. Official advice for those facing a bushfire is to either leave the area or stay and defend their properties. Information and investigation into bushfires suggest that those persons that are caught and perish in the flames do so in situ and are not carried away as in floods.
- e) **Earthquakes:** A sudden and violent shaking of the ground, sometimes causing great destruction. They are usually caused as a result of movement within the earth's crust. Australia is situated approximately in the centre of our tectonic plate and is therefore spared major earthquakes, although as a nation we do suffer from smaller earth movements, which are not as severe as many other countries.
- f) **Avalanche:** An avalanche is a sudden rapid flow of snow down a slope, occurring when either natural triggers or human activity causes a critical escalating transition from the slow equilibrium evolution of the snow pack. Typically occurring in mountainous terrain, an avalanche can mix air and water with the descending snow. Powerful avalanches have the capability to entrain ice, rocks, trees, and other material on the slope. In contrast to other natural events which can cause disasters, avalanches are not rare or random events and are endemic to any mountain range that accumulates a standing snow pack.
- g) **Subsidence:** The gradual or swift caving in or sinking of an area of land. This is becoming a more common feature in areas where developments have been built over old coal mines.

Urban SAR (USAR)

3.17.34 Urban search and rescue (USAR) is the search for and recovery of survivors and deceased persons trapped within or under the rubble of collapsed buildings, tunnels or other structures. This type of search is generally the province of the Fire Service within each State/Territory and as such will not be touched upon in this section. SMC's should bear in mind that these searches will often go hand in hand with normal SAR incidents.

Coordination

3.17.35 It is imperative that a search and rescue mission be commenced at the earliest opportunity in order that any survivors are given the maximum chance of being located and recovered safely. At the time it is determined that persons are missing as a result of a disaster a senior SAR Coordinator should be advised and called into the MIR or Operations Room. This Coordinator

will be responsible for initially assembling a team, recommended five SAR trained member minimum, to travel to the disaster area. While there are normally SAR trained members spread throughout each State the major source of experienced members would be the Search and rescue Assets/Water Police in the short term. These members can be deployed immediately and should be rotated and/or replaced on a roster system in conjunction with the Senior SAR Coordinator and other assets. Where required an Overarching SAR Supervisor should be appointed to provide advice, guidance and support in situations where more than one search location is required.

Initial Actions

- 3.17.36 The incidents described above can occur without any warning or with minimal warning. The science of disaster prediction is still in its infancy and authorities are always caught between issuing warnings too early and panicking the community or issuing warnings too late and not allowing the community to take proper preparations. In many instances the trigger points for the issuing of warnings are very close to the actual occurrence of the event.
- a) **Extent of the incident:** The SMC should endeavour to determine the extent of the incident. In many of the above disasters the actual area of destruction will be limited to a relatively small area. Flooding and bushfires have the potential to cover large areas.
 - b) **Population details prior to incident:** In order to determine the number of missing persons within a particular area the SMC will need to obtain information as to the original population in that area. This is inherently difficult as many families and persons are displaced from their homes and are either placed in shelters in other locations or with friends and relatives. In the first instance the number of missing persons will always be high until detailed lists of survivors can be compiled by agencies such as Police, Community Services and the Salvation Army. Although this information is vital in the planning for a SAR incident, don't postpone the commencement of the SAR because this information is not immediately forthcoming.
 - c) **Last known location of the MP's:** Where possible information of the last known point of each missing person should be obtained as a starting place for the planning of the SAR response. Again this is very similar to the problem above in that this information may not be forthcoming until several days into the operation.
 - d) **Lost Person Behaviour:** There is no LPB that details the post distress actions of persons caught up in the above disasters. Given sufficient warning for some of the disaster types, such as bushfires, persons have the choice of either fleeing the area for a safer location or staying and fighting. The actions of the other disaster types are so difficult to predict that general advice is to evacuate the area. For those persons that remain behind and are caught up in the incident it is extremely difficult to predict where will be the best locations to commence a search.

Working under or within a MIR

3.17.37 A MIR and/or PFCP will be set up in conjunction with a Local Government Disaster Centre. The State Disaster Coordination Centre may also be activated if the initial incident warranted. The SAR component of the incident is but one small role within a wider response and recovery operation. The most senior member assigned to the incident will be the Incident Commander and will therefore set the tone of the response and recovery. The SAR system fits underneath but is separate to the MIR. Whilst he/she must follow the directions of the Incident Commander, the SMC is the member running the SAR response. The SMC will be competing with other assets and agencies for the limited resources available initially at any disaster incident. The SES required to conduct searches will also be required to assist in disaster centres, other activities and generally assisting the surviving population. Other assets such as helicopters, four wheel drive vehicles, boats, heavy machinery and ADF resources will be competed for. The SMC should prepare a detailed search plan, outlining the objectives and equipment/resources required to conduct the search phase.

MIR Liaison Officer

3.17.38 The SMC should consider, at the earliest opportunity, in having a Liaison officer appointed between the MIR and the SMC. This member would work from within the MIR and be in a position to pass on details that would be useful in a SAR incident that may otherwise not be forwarded. These details will include information obtained from a variety of sources such as detectives, traffic, SES, Local Government. The type of information useful in a SAR incident will include:

- a) Last known location of missing persons
- b) Clothing worn when last seen
- c) Statements from people last seeing MP's.
- d) Other people with MP's
- e) Other sightings of MP's

Field Search Headquarters

3.17.39 The location of the FSH is normally determined by the SMC.

3.17.40 Where possible it should be in or very near the search area. This is to limit time travel, to allow the SMC to have very good situational awareness and allow ground to map accurately. As the area will have recently suffered destruction there may not be the normal facilities found at most FSH's. The SMC will need to source communications, tents, power, tables, maps etc. (local SES can assist). The ADF can also assist if a DACC request is made. The FSH needs to be secured and away from the public eye. Access should be limited to necessary SAR personnel. A briefing area should be set up adjacent to the FSH, close to an assembly area. Welfare, toilets, food, communications and stores will be within the immediate area.

3.17.41 Each distinct search location should have a separate SMC to coordinate the SAR response. If there are two or more distinct search locations then a senior SMC will need to be appointed to provide an overarching supervisory and coordinating role.

3.17.42 Each SMC should be provided with a team of four SAR trained members:

- a) **Assistant Search and Rescue Mission Coordinator:** This member will provide day to day assistance to the SMC. They will be responsible for putting into action the SMC's plans and for providing an alternate opinion during the plan development stage to ensure that all contingencies are being covered.
- b) **Planner:** This member will be responsible for determining the search areas, plotting these onto the map on a daily basis or otherwise as determined by the SMC. They are also responsible for the allocation of the search teams and completion of all area, speed,

distance and time calculations in order to provide advice to the SMC. This member will also manage the task sheet distribution and collection.

- c) **Intelligence:** This member will be responsible to the SMC for the collection, collation, evaluation and dissemination of all information arriving at the FSH. They will filter and value add to any information obtained, check it against current and past tasks and where necessary forward the information to the Planner for assigning. This member will also manage the white board at FSH.
- d) **Administration and Logistics:** This member, working in conjunction with the A/SMC, Planner and Intelligence will source the necessary resources to enable the search to proceed. They will also be responsible for re-supply of teams, rest and rotation of teams, food, welfare, fuel, travel arrangements and any other task assigned by the SMC.

3.17.43 On a protracted search it would be necessary to rotate the entire FSH staff on a five day basis. The Senior SAR Coordinator will be responsible for organising fresh teams to rotate through each FSH. On the morning of day five the new team will arrive at the FSH, with each fresh member pairing off with the member they are replacing. Past experience suggests that a four hour handover will provide all the necessary information, thought processes, plans and current tasks to the oncoming team. The original team can then depart for their home stations for rest and relaxation.

3.17.44 A five (5) member FSH will provide a professional response to a delicate and sensitive situation. It will also provide the Incident Commander with the best possible chance of achieving a reasonable outcome.

Searching

There are a number of steps to follow to ensure that the best possible search is conducted within the area of the disaster. In most instances the SMC will be looking for deceased persons, more than likely hidden in the debris left behind after the incident.

- a) **First Land Search:** Once the area of destruction has been identified and the initial danger has passed the first search can commence. The aim of the first search is to clear all buildings, houses, shops, sheds, barns, vehicles and other potential places of entrapment. The first search will be similar to a fast search, the aim of which is to ensure that all survivors are located and removed to a place of assistance. While the best medical advice suggests that there would be very few survivors in most of the disaster types there are numerous instances where a survivor has been located days after the initial incident, often protected by the very debris that proves fatal for most persons. Local SOP's will deal with the actions to be taken in this event.
- b) **Second Land Search:** The second search is a more thorough search of the areas covered by the first search and any other areas identified as requiring searching. This search is more akin to a general search in which the searchers are going to make a more thorough search of each of the buildings and surrounding countryside within each search area. This search will require a large number of searchers to ensure an adequate coverage of the search area. In those areas inundated with mud, flash flooding, tsunamis, earthquake and subsidence there will be large amounts of debris piled up against any solid walls or barriers in the destruction area. These debris fields will need to be thoroughly searched, to the extent that these debris walls will need to be pulled apart and sifted through. In many instances the mud will eventually set as hard as concrete and will require heavy machinery to dismantle. During this stage it is very important that searchers sift through the debris as it is pulled apart to ensure that deceased persons are located.
- c) **Third Land Search:** If necessary a third search may be conducted of all or a part of the search area. This may be required due to weather or other circumstances that may have degraded earlier searches. Unusual odours or debris piles not previously dismantled will need clearing before an area can be identified as clear.

-
- d) Fourth and subsequent Land Search: A fourth and subsequent searches may need to be carried out in some areas of the search location due to a variety of factors including:
 - i) Area still inundated with water;
 - ii) Conditions are not conducive to conducting a thorough search;
 - iii) Current conditions are considered unsafe, particularly where buildings are concerned;
 - iv) Continued ground tremors;
 - v) Continuing rain; and
 - vi) Insufficient resources, necessity for specialist crews, to complete search.

Land Search problems

3.17.45 Unlike general SAR operations, searching in mass victim incidents will require different techniques. There are a number of different situations that will need to be taken into account by the SMC:

- a) Searching **shops, houses, flats and apartments**: A full search will need to be conducted of the interior of all houses, flats and apartments that were affected by the incident. This search should include all rooms, cupboards, wardrobes, hutches, fridges, washing machines, etc. Underneath all buildings will also need to be cleared. Those buildings on stumps may not pose the problem of those buildings closer to the ground. Flood water and mud can carry persons into and under buildings where they may become trapped. **(Before doing so, ensure buildings are determined structurally sound.)**
- b) Searching **open areas, paddocks, parks and farmland**: As a result of flooding and/or mud these open areas can be covered in either water, mud or a combination of both. Searching these areas is man power extensive and time consuming. They must be covered slowly, with a visual horizon as close as 2m, and a slow walking pace. Long metal poles will also assist in testing the mud for buried persons. A searcher will notice the difference as they push a metal pole through the mud and into a deceased person. Searchers should also beware that there will be cattle, sheep and wildlife buried within the mud that will produce a similar smell and feel to a deceased person.
- c) **Search creeks, waterways, gullies, drains etc.**: Flooding water and mud will generally take the path of least resistance, which normally will be creeks, gullies, waterways and drains. The depth of water in these may require specialist assets to assist in searching, such as Divers. The force of the water and mud will also push motor vehicles, household items and other debris into these waterways. Each one of these items will need to be located and recovered from the water in order that they can be cleared as empty. Animals such as horses, cattle and wildlife will also be found in the water. As they could be masking human remains they will also need to be recovered and checked.
- d) **Searching mountainous areas**: Mountainous areas pose a wide variety of problems for a SMC, in particular the necessity for searchers to have specialist skills in mountain climbing and/or snow searching. Avalanche victims have a very limited golden period requiring searchers to be deployed within minutes of the incident occurring. Transport to the incident site may be limited due to road and rail closures. Rotary wing assets will be the best option.
- e) Search **Fatigue**: Although the search areas used in these situations will be smaller than in general SAR operations the intensive searching required will cause the searchers to succumb to fatigue quicker than usual. Searching areas while wading through water and mud will also impact on the physical ability of searchers, limiting their useful capability and requiring regular rest and rotation.

3.17.48 Utilising the urban property plan below the SMC can allocate a block to each SES or other team for searching. The briefing would be able to include the number of properties within the search area and the type of buildings likely to be encountered. As each property is checked for survivors, deceased or other it can be marked accordingly. Those properties that cannot be searched for a particular reason (Unable to reach location, building structurally unsound etc.) can then be easily identified at a later stage for further investigation

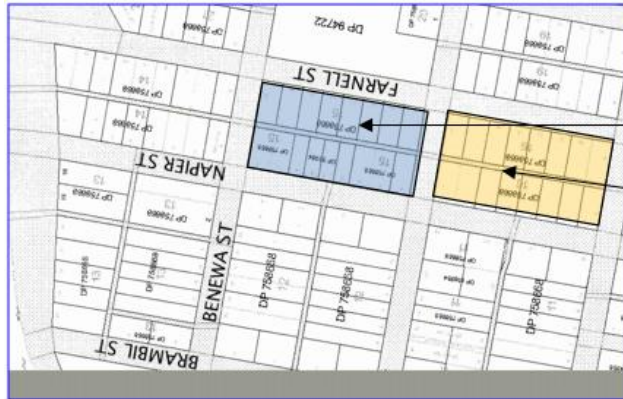

Each search area is coloured a different colour for each search team. Blue Team has 15 Properties to search in their block while the Orange Team has 14. The size of the blocks and number of individual properties will provide the SMC with an indication of the times involved.



Upon return by the teams the master plan can be marked indicating what has happened. Both teams managed to search all their blocks apart from two properties each, marked in red. The black stars mark where deceased persons were located. The red properties will need to be search at a later time and possibly by a different method.

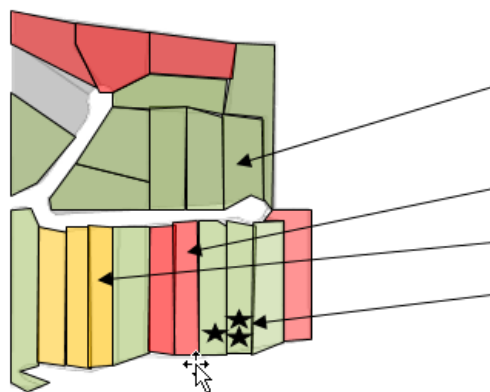

A rural portion of land can be similarly divided up into property size search areas which can be easily tasked and then colour coded after a search. Green are cleared properties. Red have not yet been checked for some reason. Orange areas need further searching, possibly a smell etc. Deceased are again indicated by a black star.

Figure 3-68 Utilising Urban Property Plans

Tasking sheets

3.17.49 Tasking sheets have been developed to ensure that all of the identified tasks within the search are properly undertaken and completed. The SMC should ensure that each task is recorded in duplicate at least, providing one to the search team leader and keeping one at the FSH as reference. As the task is completed the original can be signed off and filed. At the conclusion of each day any uncompleted tasks can be identified and reassigned if necessary. The task sheets will enable the SMC to provide a detailed summary of the searching on a daily basis. Electronic mapping programs allow easy input of search areas as they are completed, again providing the

SMC with an easily readable summary of the daily activities. They will also form the basis of a Coronial File, which will always follow a major disaster with loss of life.

Briefings

3.17.50 Briefings to search teams and search team leaders are generally given in the SMEAC format.

- a) **Situation:** The situation will be a precise of the incident occurrence and subsequent events.
- b) **Mission:** The mission should be a short statement of intent i.e. to locate missing persons in the search area.
- c) **Execution:** The execution section will be the most important part of the briefing as it will provide the search teams with the tools to perform their assigned tasks. Each situation will be different and the methods of searching will be dependent on the terrain, disaster type, number of volunteers, weather and time frames.

Execution Factors:

- i) **Deceased persons:** Deceased persons meet their demise in many different ways. Bushfire victims may vary from no visible signs of burning to totally incinerated with no resemblance to a human. The degree of destruction depends on the severity of the fire, location of person, speed of the fire and any actions the victim may have made to protect themselves. Many bushfire victims succumb to asphyxiation as the fire consumes all the oxygen in the area. Others will breathe in the superheated air and perish as a result of the complications of the internal burning. Searchers must be made aware that their targets will range from an intact human to a small pile of dark ash. Flood and mudslide victims will normally retain their human shape, although due to the force of the water/mud it may be distorted and out of shape with broken bones and internal injuries. These victims will not often be found on the surface. They may be entombed within a metre or more of mud or mud and debris. The deceased may not be easily recognised as they are often coated with mud and blend into the background. Those that are left uncovered after the waters recede will often discolour and darken quickly as decay and sunburn sets in. Victims from building collapse as a result of earthquake or subsidence are often distorted and misshapen due to the extreme weight suddenly falling on them.
- ii) Searching for deceased is a combination of all senses as sight alone will not be enough. The distinctive smell of decaying flesh may greet the searcher as they near a potential area. Keeping an eye on the shape of the ground may unearth a buried victim. Observing an area of darker ash in a human shape may identify a victim. Searchers may also use thin metal poles to prod into the ground, the change of pressure or sudden change of odour may suggest the location of a body underneath. Thermal imaging cameras and ground radar can be used if available. There is no record of any success to date. Cadaver dogs may also be considered, although they work best when the deceased are about week old.
- iii) Location of deceased: Local SOP's will determine the actions on location of deceased persons. These should be included in the briefing to ensure photographs and examinations are made prior to recovery in case of foul play. The location should be recorded by GPS or other accurate means to enable it to be plotted for the final report. Depending on the incident, a large number of animals will be located and will require the services of a doctor or forensic member to determine if they are human or otherwise.
- d) **Administration and Logistics:** Re-supply, body bags, disinfectant, insect repellent, sun screen, fatigue, meals, water, transport, PPE are some of the items needed to be covered in this section.
- e) **Command and Communications:** This section is common for all SAR incidents.

-
- 3.17.51 Ensure a full and detailed description of the person or item sought, including clothing. This will enable recognition of any discarded items of clothing or parts. When searching for missing persons the most obvious identified is often the only feature needed to be included in the briefing. Too much detail provided to searchers can sometimes obscure their ability to identify their target.

Record Keeping

- 3.17.52 As per all SAR incidents, detailed records must be kept for future reference. They will include:
- SAR Log:** A detailed chronological record of decisions and actions taken during the SAR incident. With respect to disaster searches, all decisions with respect to deployments, asset allocation, briefings, and debriefings should be recorded. The log will also include such details as daily sunrise and sunset, weather conditions, topographic hazards, SAR teams and hand over notes.
 - Task sheets:** Should be completed in duplicate, original for the search team and duplicate for the FSH. The original sheets should be collected from the search teams as they return to FSH. If the task has been completed it can be closed. If the search team was unable to complete the task for whatever reason, the task can be reassigned at a later date.
 - Map overlays:** Depending on the size of the search area and the number of search teams there may be a map overlay for morning and afternoon or for a single day. Each overlay should have the map number, date, time and SMC name in the top right corner. The top left and bottom right should have two reference marks so that the overlay can be aligned with the map at a later date. The actual areas designated and those searched can then be drawn in permanent marker on the overlay. As the SAR develops successive overlays can be placed on top of each other to determine what areas have been missed and what need to be researched.
 - Radio log:** This log will normally be maintained by the SES and will be a complete record of all radio traffic to and from FSH for the duration of the SAR operation.
 - Briefing notes:** A written copy of each daily briefing should be filed for future reference.
- 3.17.53 **Electronic recording of search:** There are a number of electronic aids that can greatly assist the SMC in recording information and briefing up and down the chain of command. One of the biggest problems associated with SAR is the accurate identification of areas searched. At present this is done through a combination of map work and GPS usage. Where available GPS data can be downloaded onto a mapping program to give an accurate picture of where search teams went. This enables the SMC to know if the briefings were sufficient and if the directions were followed. Other electronic devices such as ArcPad's or similar instruments have the ability to provide mobile field mapping and data collection. This information can then be sent via the mobile telephone system to a server for instant production on a FSH computer terminal. Used in conjunction with a GPS and date stamp enabled digital camera, pictures can be taken of any object of interest and transmitted instantaneously to the FSH. This has the ability to allow the SMC to observe victims in situ, debris mounts and other points of interest while communicating with the search team. These photos can then be saved against that location for future reference.
- 3.17.54 This information instantly allows the SMC to identify each property as it is being searched, and what the property looks like in real time. The Incident Commander could also view these details from their office without the need to visit the scene. These electronic aids could also provide information to assist the Coroner during any subsequent inquest as any of the properties involved in the incident can be viewed, as can the initial location of motor vehicles, persons and buildings if necessary.
- 3.17.55 **Summary:** It is important to consider all the factors described in this chapter, along with information obtained about the missing person(s) prior to planning the search.

Evidentiary Searches

- 3.17.56 The skills associated with SAR are transferable to searching for crime evidence and this has become an increasing practice for land SAR coordinators.
- 3.17.57 Although generally outside the scope of actual SAR the processes for an evidence search follows the same procedure as would be adopted for a missing person.
- 3.17.58 Most evidentiary searches fall into the following categories:
- a) Searching for weapons from a crime
 - b) Searching for evidence discarded by a fleeing offender
 - c) Searching for victims of violent crime
 - d) Searching for clandestine graves
- 3.17.59 The targets for these type of searches can include:
- a) Bladed weapons
 - b) Blunt force trauma weapons
 - c) Firearms
 - d) Rope and binding materials
 - e) Stolen property
 - f) Clothing
 - g) Blood and hair
 - h) Deceased persons
 - i) Clandestine graves
- 3.17.60 General and contact searches are the most commonly used for evidence location. A detailed search can be undertaken in a relatively small area, such as the side of a road or farm paddock. Search patterns such as purposeful meandering and parallel sweep are best suited to this type of search.
- 3.17.61 The format of an evidence search will be the same as for a lost/missing person. The following steps are to be considered in the planning stage:
- a) Obtain all possible information about the incident, including:
 - i) Target details, size, shape, colour, description, photographs, similar item for reference (There are instances where the exact search target is unknown, such as a blunt trauma instrument.)
 - ii) Method of disposal
 - iii) Location of disposal and the accuracy thereof
 - iv) Weather conditions at the time of disposal and at time of search
 - v) Size of search area, actual or speculative
 - vi) Search assets and availability (It may be worthwhile considering a planned deployment at a time more suitable to searchers if possible)
 - b) Identify resources as contained in the local resource register
 - c) Method of searching
 - d) Search aids (Cadaver dog, thermal imaging, terrain profiling, satellite imagery)
 - e) Probability of detection
- 3.17.62 A briefing, on similar lines to a normal lost person and in the SMEAC format, is to be prepared for the search teams.

-
- 3.17.63 Actions on locating any potential items of evidence will be included, as will the need for adequate personnel protection equipment for all searchers.
 - 3.17.64 Attention needs to be paid to the actual target and what effects this will have on the searchers, particularly volunteers. As these searches can be psychologically and physically upsetting, adequate warning by the SMC will allow consideration by the volunteers as to their participation or not.
 - 3.17.65 The search for body parts will always be undertaken by Police.
 - 3.17.66 Recording details of the search, including search area maps, chronological and radio logs, and briefings will be undertaken as per a lost person search.

Passive Searching

- 3.17.67 Passive searching is a type of search technique where there is no physical search involved, but more designed to allow the target to self-help.
- 3.17.68 Passive searching is most often used at the conclusion of a day search, when all teams have returned and the FSH is winding down. During the hours of darkness the FSH does not close, but remains active in that electric lighting is left on and personnel are tasked to activate strobe lighting, beacon lighting on vehicles and possibly have bonfires at strategic locations.
- 3.17.69 Aural searching may also be effective at night, loud sounds in groups of three at intervals, such as a vehicle horn, siren, air horn or firearms. A suitable amount of time needs to be left between bursts of noise to allow for any responses.
- 3.17.70 Passive techniques can also include pre-prepared deployable containers fitted with a radio, siren and strobe light. These can be deployed to strategic locations within the search area if it is believed that the target is moving and possibly attempting to self-help.
- 3.17.71 Passive techniques are not often successful with small children or persons suffering from dementia or Alzheimer's disease, although children with ADD and/or Asperger's do often respond to names or nicknames.

Chapter 4 Search and Rescue Techniques

4.1 Aviation and Maritime Search Operations

Overview

4.1.1 Volume 2, Chapter 3 described how to determine the optimal area where the available search effort should be deployed. Once the optimal search area has been determined, a systematic search for the search object should be planned. Before a search operation takes place, the search planner should provide a detailed search action plan to all involved, specifying when, where and how individual search assets are to conduct their search operations. Coordination instructions, communications frequency assignments, reporting requirements, and any other details required for the safe, efficient and effective conduct of the search must also be included in the search action plan.

4.1.2 As a minimum, developing a search action plan consists of the following steps:

- a) Selecting search assets and equipment to be used (this may be a combination of SAR specific assets, other local assets or assets of opportunity that happen to be in or near the search area);
- b) Assessing search conditions;
- c) Selecting search patterns to cover the optimal search area as nearly as may be practical;
- d) Dividing the search area into appropriate sub-areas for assignment to individual search assets; and
- e) Planning on-scene coordination.

Note: JRCC Australia and most police jurisdictions use a computer-based program to design search areas, assign search patterns, allocate assets to a search area and create briefings for search assets. The program uses the same data as is provided in this Manual.

4.2 General Guidelines for Searches

4.2.1 As discussed in the previous chapter, an aerial or maritime (whether using oceanic principles or coastal search planning) search typically involves three stages:

4.2.2 Stage 1: The immediate response;

4.2.3 Stage 2: a search based on a nominated area either side of track, and;

4.2.4 Stage 3: a search based on a mathematically derived search area.

4.2.5 The following sections describe these stages in further depth.

Stage One Search: Immediate response

4.2.6 The stage one, initial or reflex search normally consists of :

- a) A visual search along, and possibly also parallel to, the track of the target;
- b) Action to detect a signal from an emergency beacon;
- c) Formulation of a rescue plan;
- d) Coordination with Police, Airservices Australia and other agencies as appropriate; and

-
- 4.2.7 The stage one search may comprise of:
- a) Single or multiple track line searches;
 - b) Implementing procedures to detect a signal from an emergency beacon, such as monitoring by aircraft flying over the area; tasking a dedicated search asset; monitoring by aircraft or vessel on a visual Track Line search; monitoring by passes of the satellite system;
 - c) Developing a rescue plan to return survivors to a place of safety;
 - d) Preparing aircraft with SAR droppable supplies;
 - e) Arranging observers; and
 - f) Gathering intelligence relevant to the search.
- 4.2.8 The SMC should consider:
- a) Diverting aircraft or ships if they are available;
 - b) Tasking aircraft from an SRA or local resources where the urgency of the situation and the locality will determine the assets to be used;
 - c) Deploying a surface asset for search and/or rescue as may be required by the situation and location;
 - d) That the height and track spacing of search aircraft can be higher than book values as there is an expectation that an active target may be available to assist (only in this initial stage of the search);
 - e) That the coverage factor should generally not be less than 0.5; and
 - f) The use of electronic or thermal imagery equipment.

Stage Two Search: Nominated Area Either Side of Track

- 4.2.9 During stage two, the search area is normally 10 NM either side of the missing targets track for aircraft and vessels when undertaking an aerial search. Surface searching will be at smaller distances either side of the track.
- 4.2.10 This distance may be reduced or extended either side of the track after consideration of the following factors, as applicable:
- a) The speed of the missing aircraft or vessel;
 - b) The height of the missing aircraft;
 - c) Possible actions of the missing target during an emergency, e.g. an aircraft searching for a suitable area to land or attempting to reach land if flying over water, or a vessel attempting to run for shelter;
 - d) A ferry flight using GPS;
 - e) A scenic flight; and
 - f) Drift, if applicable.
- 4.2.11 A Stage Two search may comprise:
- a) A number of aircraft and surface assets assigned an area (normally ten legs) to conduct a visual search;
 - b) Helicopters assigned a specific area to conduct a visual contour search;
 - c) Arranging observers;
 - d) Provision of a dedicated communications aircraft;
 - e) Preparing and deploying aircraft with SAR droppable supplies;

-
- f) Provision of a surface search and or rescue response;
 - g) Establishment of a Forward Command Post or Forward Field Base;
 - h) Implementing a structured rescue plan;
 - i) The use of thermal imagery to locate the target; and
 - j) Establishing an intelligence cell.
- 4.2.12 The SMC should consider:
- a) Drift if the search is over water and it begins more than four hours after Splash Time;
 - b) Location of deployed SAR Datum Buoys to establish water movement;
 - c) Exercising caution in using aircraft with an endurance of less than four hours;
 - d) Increasing the distance either side of track following an unsuccessful search or searches;
 - e) Ensuring the search area includes the possible departure path and the approach pattern areas at both the departure and destination aerodromes; and
 - f) Increasing detection time over rugged terrain or rough seas.

Stage Three Search: Mathematically Derived Area

- 4.2.13 A Stage Three search is a further development of Stage Two, where the search area is expanded to cover the probability area mathematically calculated by reference to the potential navigational errors of the missing target and search assets. These errors will be modified by intelligence and any allowance for drift.
- 4.2.14 The SMC should consider:
- a) The on-going availability of search aircraft;
 - b) Provision of a suitable surface response;
 - c) The on-going availability of search crews, including pilots and observers;
 - d) Accommodation and financial arrangements for observers if operating away from home base;
 - e) Logistical support including availability of fuel for search aircraft and vessels if operating from more remote airfields and bases;
 - f) Refining rescue plans including deployment of rescue assets to the area if considered beneficial;
 - g) Location of deployed SAR Datum Buoys to establish water movement;
 - h) Further deployment of supply dropping aircraft; and
 - i) Any further avenues to obtain intelligence.

4.3 Aviation and Maritime Search Area Coverage

General

- 4.3.1 Many of the general factors involved in aerial and maritime search have similarities in their prosecution and planning and are considered together in this manual. Once the search area has been determined, a systematic search for the target should be planned. Factors such as the weather conditions, time available for search, aircraft and vessel speed, search altitude, sighting range and height of eye, size of target, etc., should be taken into account. These factors are related but some may be more important than others. In planning a search operation, the SMC should endeavour to meet the requirements of the more important factors while satisfying the requirements of the others as far as practicable.

- 4.3.2 Search Area coverage is the systematic search of selected areas of land, or water, to ensure the optimum probability of detection of the object being sought. The factors affecting detection capability have been reduced to four inter-related expressions. The terms and their symbols are:
- Sweep Width (W)
 - Track spacing (S)
 - Coverage Factor (C)
 - Probability of Detection (POD)
- 4.3.3 The type and number of available search assets will be a factor in determining search area coverage. More time will be required to search a large area thoroughly when there are limited numbers of search assets available unless the distance between successive sweeps of the area is increased. This is not desirable since it would reduce the probability of detection of the target. It may, therefore, be necessary to seek additional search assets from other sources. It is usually preferable to cover a search area from the beginning with an adequate number of search assets.
- 4.3.4 When search assets operate far from their home base, consideration should be given to them being redeployed at an advance base so that more time will be available for the search and less time will be spent on travel to and from the search area.
- 4.3.5 When using an aircraft as a search asset an adequate number of well-placed, trained observers as well as altitude and speed are important factors determining the POD of a target.

Sweep Width (W): Factors affecting Sweep Width

- 4.3.6 Sweep Width, "W", is a function of Search Visibility. It is the ideal width of the area that should be scanned after the appropriate correction factors have been applied.

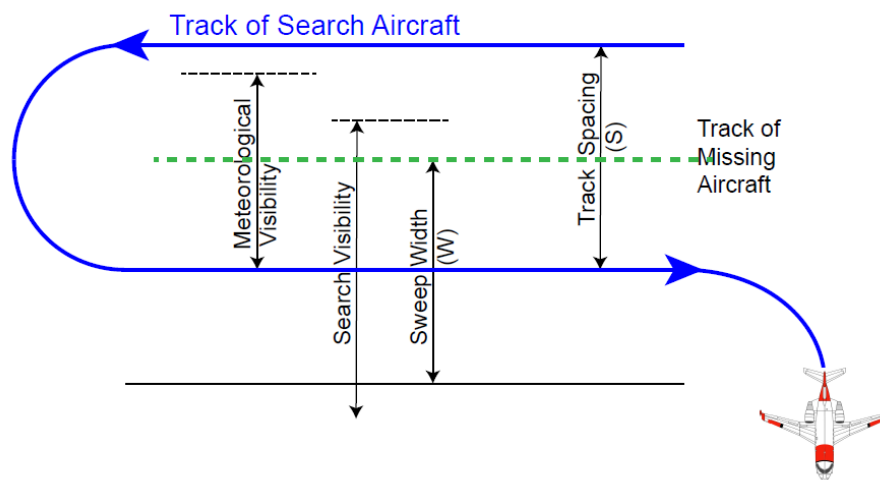

Figure 4-1 Sweep Width

- 4.3.7 There are a number of terms relating to visibility from a search asset:
- Meteorological visibility: This is the maximum visibility taking into account the weather features present in the search area at the time of the search. This will vary depending on height of asset, cloud base, cloud coverage, clear skies etc.
 - Search visibility is the actual distance a searcher can see under good conditions. A searcher may be able to see the horizon from a vessel or aircraft but would have very little chance of seeing a target at that distance.
 - Sweep width is the calculated distance that a searcher has a reasonable chance of locating the target. It is based on a bell curve where the probability of a search not seeing the target within the sweep width is the same as them seeing the target beyond the sweep width. In

Figure 4.2 (Below) the number of missed detections (B) inside the effective area swept equals the number of detections (A) that occur outside the area swept.

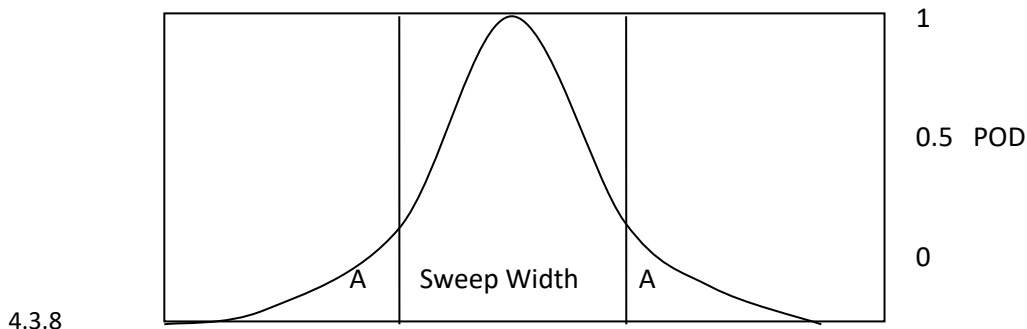

Figure 4-2 Bell curve for POD

d) Track spacing is the mathematically derived distance between each search leg. Where possible the track spacing should be equal to or less than the sweep width to ensure a high POD.

4.3.9 Search visibility and sweep width are equally split across the search track of a searching asset (refer Figure 4.1). Search visibility is the range within which a particular search target has a reasonable probability of being detected. Search visibility is affected by the numerous factors discussed below will constitute sweep width.

Type of Aviation and Maritime Target

4.3.10 The sweep width will depend on the type, size, colour and shape of the target, its colour contrast with the surrounding medium, amount of freeboard, and whether or not the target is moving. Targets may vary from wreckage of an aircraft on land to a person in the water. All targets should be sought from a direction in which they receive the best illumination, colour brightness or contrast. Over water, this is usually the direction in which whitecaps can be seen at the farthest distance.

Meteorological Visibility

4.3.11 If visibility conditions are poor, the subsequent reduction in sweep width and POD may cause an interruption or necessitate a suspension of search effort, e.g.:

- Fog makes visual search ineffective if not impossible. Only an electronic search to determine the approximate position of the target, or, perhaps, a ground search, may normally be an appropriate option;
- Smog and haze may reduce the effectiveness of daylight search and, to a lesser extent, night signals;
- Low clouds may render search ineffective or impossible;
- Precipitation, sleet and snow or other storm event reduces visibility; and
- Terrain or Sea Condition.

Type of Terrain/Conditions of the Sea

4.3.12 The type of terrain to be searched obviously affects the ease with which the search target will be detected. The more level the terrain the more effective will be the search. Not only can the search aircraft maintain a constant search altitude, but also there is less likelihood that undulations or irregularities on the terrain surface will hide the target, wreckage or survivors. Thus calm water areas and flat deserts are easier to search than rough seas or rolling hills, while rugged mountain areas are the most difficult. The more trees, vegetation, rock outcroppings and other surface irregularities that exist on land, the more difficult will be the search. Likewise the more whitecaps, wind streaks, foam streaks, breaking seas, swell systems, salt spray and sun reflections, the more difficult will be a search over water.

-
- 4.3.13 In addition, patches of seaweed, oil slicks and flotsam may be mistaken for life rafts, or worse, a life raft may be mistakenly identified as seaweed or flotsam. On a glassy sea any object, or disturbance, will probably attract the attention of a searcher's eye. On a glassy or smooth sea accompanied by a swell system, chance of detection is also good, being lessened primarily by the intervals in which the object is in the trough between swells. During such intervals, the object may be hidden from the observers of a low-flying search aircraft or the lookouts of a ship. With small targets on glassy seas, however, difficulty will be experienced in detection due to the reflections of sun, sky and clouds on the sea surface.
- 4.3.14 The presence of whitecaps and foam streaks on the water breaks the uniformity of the surface and markedly reduces lookout effectiveness. As the whitecaps become more numerous, the probability of detecting a small object becomes less. With numerous whitecaps and foam streaks in a heavy, breaking sea, even very large objects are difficult to detect, and small objects are unlikely to be detected at all.
- 4.3.15 With high winds, which accompany rough seas, visual aids are rendered less effective. Dye marker tends to dissipate rapidly and smoke signals cling close to the surface and cannot be differentiated from the foam streaks. The reflection of the sun off the breaking seas and whitecaps tends to dull the perception of lookouts to visual signals. With high winds, the wind-driven salt spray constitutes a very real visual obscuration due to both a reduction in visibility and the accumulation of salt on the search craft's windows.
- 4.3.16 Rough seas also adversely affect RADAR detection due to the large amount of sea return on the scope, and the fact that small targets in the trough of a sea cannot be detected.
- 4.3.17 The weather correction factor (Fw) is applied to the sweep width calculation to account for the degradation in weather conditions. This generally means that sweep widths will need to be closed to achieve a good POD in poor conditions.

Search Aircraft Speed

- 4.3.18 At low search altitudes the speed of the aircraft will affect the sweep width due to the angular velocity causing targets to:
- Move through the RADAR scanner's field of view, blurring the targets at very close ranges, and decreasing the exposure time the targets to the scanner.
 - Move through a searchers field of view, again resulting in the blurring of the targets and limiting the time to identify and respond to a target being seen.
 - Generally, higher speeds will increase the adverse influence of these factors at search altitudes below 500 feet.

Fatigue Factor

- 4.3.19 The effectiveness of observers depends on the number available, their experience, alertness, physical condition, incentive and the suitability of observing positions. The speed at which the search asset moves also has a direct relationship to the effectiveness of the observers' overall performance.
- 4.3.20 If feedback from the search asset indicates that search crews were excessively fatigued, use a correction figure for fatigue and reduce the sweep width by 10 per cent (multiply the uncorrected sweep width by 0.9).

Search Aircraft Height

- 4.3.21 Several factors; the prime ones being the size and nature of the target being sought, and the surface conditions surrounding the probable location of the target dictate the selection of the search height. Recommended search heights for particular targets are listed in Table 4-1.
- 4.3.22 Search heights will be quoted as height above ground level (AGL) or above mean sea level (AMSL).

Over Water	Recommended Height
Survivor without raft or dye marker	Below 500ft
Survivor in raft without dye marker, or signalling equipment	800-1500ft
Survivors with dye marker	1000-2000ft
Survivors with signalling equipment and/or RADAR reflector	1000-3000ft
Over Land	Recommended Height
Level terrain with little or no foliage	1000ft
Level terrain with heavy foliage	500ft
Mountainous terrain (height selection governed by turbulence and foliage density)	500-1000ft

Table 4-1 Recommended Search Heights

- 4.3.23 Meteorological conditions must be taken into account when selecting search heights. Turbulence, cloud base, and visibility, are the chief considerations.
- 4.3.24 For reasons mostly related to the apparent movement of the surface below a search aircraft, certain minimum heights are recommended according to an aircraft's speed. They are:
- a) 2000 ft., where the speed exceeds 200 kt; and
 - b) 1000 ft., where the speed is between 150-200 kt.
- 4.3.25 Advantage should be taken of the characteristics of helicopters to search at low level, possibly in conjunction with fixed wing aircraft operating at higher levels above. This practice is supported by IMO Resolutions A.225 (VII) - Homing Capability of search and rescue aircraft and A.616 (15) – Search and rescue homing capability.

Cloud Cover

- 4.3.26 The greater the amount of cloud cover, the less will be the ambient light in the search area. This has a detrimental effect on the sweep widths of surface targets. In addition the variable surface shadows caused by scattered or broken clouds make it more difficult to visually detect targets due to the constant dulling effect of the shadows and the mottled appearance of the surface. Although a high, solid overcast will eliminate glare, shadows and reflection from the surface, this advantage is not as large as the detrimental effect of less ambient lighting.
- 4.3.27 Cloud cover is often referred to in Octa's (Eights). Zero (0) Octa's is a cloud free sky, while eight (8) Octa's is total cloud cover

Position of the Sun

- 4.3.28 Objects are seen at a greater distance when looking down-sun as opposed to up- sun particularly when the sun is in a position to reflect from water. With a clear sky and a bright sun, search conditions are at an optimum between mid-morning and mid-afternoon when the sun is high. Waterborne objects that have a high free board may sometimes be seen even in the sun's glare. Bright sunlight is especially detrimental when haze is present, due to the diffusion of light. Colour contrast is lost when looking up sun, with the result that small objects merge into a confused pattern of glaring light and shadow. Down-sun the sea appears much darker, glare is absent, haze is more transparent, and coloured objects show a marked contrast to their background. Observers forced to look into the sun suffer loss of visual acuity, and may fail to detect an object. When possible, search legs should be orientated to prevent observers having to look directly into the sun. If this is not possible observers should be equipped with sunglasses.

Day and Night Factors

4.3.29 In some conditions of wind and sea, daylight visual aids may be ineffective. The heliograph is an exception, but sunlight cannot always be expected. Sea conditions and wind have little effect on a night flare search, or on lights. When high winds and seas prevail, night search techniques usually offer the best POD. The quantity of pyrotechnics available to survivors is usually limited, and survivors are unlikely to fire pyrotechnic signals until sighting the lights of the search asset. For this reason sweep width for a night search should be based, not on the expected sighting range of the pyrotechnic aids, but on the range at which survivors may see the navigation lights of the search asset. On entering a search area, search assets should turn on all possible lights, and from time to time display searchlights, or landing lights, to facilitate sighting of the search assets by survivors; however observer night vision needs must be taken into account. Ships in a search area should be asked to make smoke at intervals, during daylight hours.

First Search Light/Last Search Light

- 4.3.30 Times of first and last light at the departure and destination points may limit the time available in a search area when all or part of a flight is governed by Visual Flight Rules.
- 4.3.31 Any limitations to visual searching indicated in a search forecast must be allowed for at the planning stage.
- 4.3.32 The 45-minute periods after sunrise and before sunset are considered unsuitable for daylight visual searching due to visibility restrictions produced by the low elevation of the sun, causing lengthy shadows.
- 4.3.33 These periods are therefore commonly discounted for visual search at the planning stage. The periods may, however, be varied at the SMC's discretion to accommodate local conditions. There may be other factors arise that impact upon search planning with greater moment thus indicating the relative suitability of visual search during some or all of these periods.
- 4.3.34 Within proximity of the equator, where the apparent movement of the sun is at a greater angle to the earth's horizon and its rising and setting phases more rapid, these periods are less critical.
- 4.3.35 Examples of local factors that may need to be considered in the context of available search light are:
- a) A search over tropical rain forest may best be started at dawn in consideration of a likely deterioration in local weather conditions later in the day;
 - b) A search of the western slopes of steep sided valleys may best be delayed until mid-morning; and
 - c) A search of steep eastern slopes may best be abandoned earlier than 45 minutes before sunset.
- 4.3.36 Time available to aircraft outside the periods suitable for visual search may be utilised in other ways, for example, beacon homing, RADAR search or FLIR search.

Miscellaneous Factors

4.3.37 Among the miscellaneous factors affecting sighting are shadows cast by clouds, rain showers, large patches of seaweed, and pure chance. Shadows cast by scattered and broken clouds are a distracting influence on the observers. Rain showers can result in areas not being searched effectively, as the object of search may be hidden by a squall. Despite all other factors, some sightings are made as a result of pure chance. An observer may just look at the right spot at the right time, conversely a momentary lapse on the part of the observer may allow the object of search to be passed unseen. The only safeguard against this possibility is to make repeated searches of an area if sufficient search assets are available, and the use of the maximum number of observers.

Searches begun early in the day, or extending late in the day have reduced chance of success in wooded terrain due to the shadows cast by the trees and the oblique angle of the sun. These

areas are preferably searched when the sun is higher in the sky. Likewise because of the sun, mountainsides may be better searched in the early or late in the day depending on the direction the particular slope faces.

- 4.3.38 Different search heights will produce different sweep width values. It is good practice to calculate sweep widths for several search heights, enabling the search planner to select a sweep width to suit a search height dictated either by the target, or one best suited to the search aircraft to be used.

Sweep Width Calculations (W)

- 4.3.39 Tables of uncorrected sweep width values and correction factors are provided in Appendix D-5:3 to D-5:6. The sweep width used in planning and evaluating the search is computed as the product of the uncorrected sweep width and all the correction factors that apply. When using Appendix D-5:7 weather correction factors use the worst case. Therefore if the wind is 10 knots but the sea is 5 ft., use the figures in the second row.
- 4.3.40 To use the Sweep Width tables the following formula applies:
- 4.3.41 Vessels: Sweep Width (W) = Uncorrected sweep Width (Wu) x Weather Correction (Fw or Wx) x Fatigue (Ff)
- 4.3.42 (Target is a person in the water, height of eye of vessel is 8', visibility is 15km, wind is 20kts and seas are 1.5m. The vessel crew is fatigued.
- 4.3.43 $W = 0.3\text{nm}$ (from the Sweep Width table for vessels) x 0.5 (Weather correction factor table) x 0.9 (Fatigue section 4.3.18)
- 4.3.44 $W = 0.3 \times 0.5 \times 0.9$
- 4.3.45 $W = 0.135\text{nm}$ (0.25km)
- 4.3.46 Aircraft: Sweep Width (W) = Uncorrected sweep Width (Wu) x Weather Correction (Fw of Wx) x Velocity (Fv)
- 4.3.47 (Target is a person in the water, helicopter is flying at 500', speed of 60kts, visibility is 10km, wind is 20kts and seas are 1.5m)
- 4.3.48 $W = 0.1$ (from Sweep Width for helicopter table) x 0.5 (Weather correction factor table) x 1.5 (Speed correction factor table)
- 4.3.49 $W = 0.1 \times 0.5 \times 1.5$
- 4.3.50 $W = 0.075\text{nm}$ (0.14km)

Track Spacing (S)

- 4.3.51 Track Spacing (S) is the distance in nautical miles between adjacent search legs. The desired track spacing is a function of detection capability. The more difficult the target to detect, the closer the search legs should be. Decreasing the track spacing increases the POD, but at the expense of reducing the area searched in a given time. There is a limit to which S may be reduced due to the limits of search assets navigation ability and accuracy. The optimum track spacing is one, which permits the maximum expectation of target detection in the available time, or is consistent with the economic employment of search assets. Whenever possible Track Spacing (S) should be used that is equal to the Sweep Width (W).

Note: For the coastal search model, the following standard track spacing is recommended on search objects less than 30 feet high.

- 4.3.52 Good Search Conditions. In conditions where the wind speed is less than 15 knots and/or visibility is greater than 3 nm (5.5km), use a track spacing of up to 3nm (5.5km) by day or night but reduce the separation depending on the size of the search target. After dark, the effect of the searchlight should be considered.

4.3.53 Poor Search Conditions. Where winds are greater than 15 knots and /or visibility is less than 3nm (5.5km) but greater than 1nm (1.9km), a track spacing of 1nm (1.9km) should be considered by day or night but reduced depending on the size of the search target. After dark, the effect of the searchlight should be considered.

4.3.54 Person in Water. When searching for a person in the water it should be assumed that the person is not wearing a floatation device and will therefore be more difficult to detect. For good search conditions a track spacing of 0.25 NM (0.45km) should be considered. For poor search conditions, the track spacing should be reduced as appropriate, taking into account the visibility and the navigational and operational capabilities of the search assets.

Note: The track spacing suggested is given as a guide only. The track spacing used in any one search will be decided by the SMC in consultation with the OSC taking into consideration all the available information at the time.

Coverage Factor (C)

4.3.55 The quality of coverage for any sweep depends on the relationship between Sweep Width and Track Spacing. The relationship is termed Coverage Factor.

$$\text{Coverage factor (C)} = \frac{\text{Sweep Width (W)}}{\text{Track Spacing (S)}}$$

4.3.56

4.3.57 The relationship between Sweep Width and Track Spacing determines the Probability of Detection (POD).

4.3.58 Higher coverage factors indicate a more thorough coverage. Higher values of C offer a higher probability of target detection; however the higher POD is not proportional to the extra search effort required.

4.3.59 Whilst a coverage factor of 1.0 is most desirable there are occasions when terrain, time limitations, large search area, or shortage of search craft, prevent its attainment. For such occasions an alternative approach must be used that balances the factors of available search hours, size of area and C.

4.3.60 A coverage factor of less than 0.5 is unsatisfactory in itself.

Aviation and Maritime Probability of Detection (POD)

4.3.61 Probability of detection (POD) is the statistical measure of search sensor detection performance. It is a function of sweep width and track spacing. It is a conditional probability meaning that search planners assume the search target is in the search area.

4.3.62 A definite POD exists for each scan made by a search observer or piece of detection equipment. The probability that a contact will be made in a single scan of a point on the surface is called the instantaneous POD. The instantaneous POD, repeated by successive scans as the search assets moves along the track, develops the probability pattern of a given search. The POD is not uniform over the swept area. In general, it is highest near the search asset and decreases with distance from the search asset.

4.3.63 POD is a function of the coverage factor (c), which itself is derived from the relationship of sweep width to track spacing; and the total number of searches in an area. For repeated searches of the same area, the cumulative POD is obtained by making use of the average coverage factor. The application of this concept results in a progressive increase in the POD of a target in the most likely sector of the search area by repeatedly searching the original area within progressively larger areas, a part of each overlaying the original. Thus there results an aggregate POD after successive searches of part of a probability area. For each successive search, the safety factor is increased, and, as a result, the size of the probability area is enlarged. It is not to be thought that early search effort should be restricted in anticipation of the benefits of the expanded search

technique; these will take time to accrue, and time, in the rescue of survivors, is of the essence. Neither should a particular search be prolonged unnecessarily in similar anticipation. Still, the concept of expanded search does allow flexibility in search planning in as much as the desired quality of search, if unattainable on account of limitations in the availability of search asset, may be attained by repeated effort, while ensuring that the most likely area is rapidly and repeatedly covered.

	Coverage Factor 1	Coverage Factor 0.5
Initial Search (R1)	78% POD	47% POD
First Expansion (R2)	95.6	71.9
Second Expansion (R3)	98.9	85.1
Third Expansion (R4)	99.7	92.1
Final Expansion (R5)	99.9	95.8

Table 4-2 Coverage Data Example

- 4.3.64 The data in Table 4-2 confirms that by making five searches of the initial probability area, each to a coverage factor of 0.5, the cumulative POD (95.8%) is only slightly less than if the same five searches had each been made at a coverage factor of 1.0, (99.9%). The search effort in the former case would have been considerably less in terms of aircraft/vessel hours than in the latter. Further, a significantly larger area surrounding the initial probability area would have been searched, albeit at a progressively diminished level of intensity.
- 4.3.65 From the foregoing, it is apparent that for prolonged and repeated searches when aircraft and vessel numbers are limited, a coverage factor of 0.5 offers a reasonable coverage of an expanded area resulting, over time, in a good POD. Search of areas at a coverage factor less than 0.5 is not recommended.

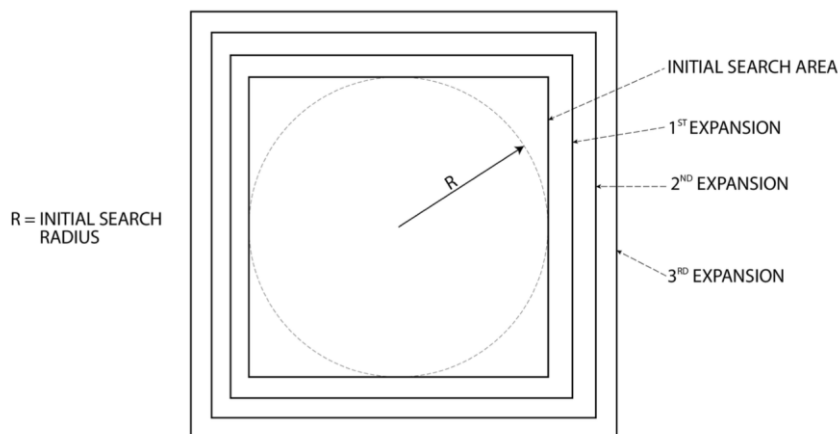

Figure 4-3 Search Area Expansion (Not to Scale)

- 4.3.66 Statistically, the target is more likely to be nearer the last known position, or datum, than in the outer reaches of the expanded search area. Application of the expanded search concept ensures that the greatest search effort is concentrated over the most probable position of the target where the POD is highest. Clearly, the expanding search procedure is best suited to situations where the approximate position or, at least, the planned track of the target is known. To ensure the concentration of search effort around the most probable position, drift and other environmental factors must be continuously factored in.

- 4.3.67 POD graph is contained in Appendix D-5:12. The bottom horizontal line is the Coverage factor (C) and the vertical side is the Probability of detection (POD) as a percentage, starting from 0% at the bottom to 100% at the top. The graph also contains five search lines, relating to the first, second, third, fourth and fifth search of the same area. To use the graph identify the Coverage factor (C) from the search, then follow this factor upwards until it crosses the appropriate search line. The POD can then be read on the vertical scale, e.g. a Coverage factor for a first search is 0.8, and the POD would be approximately 68%.

1st Search	Coverage Factor	0.5
2nd Search	Coverage Factor	0.7
3rd Search	Coverage Factor	0.3
4th Search	Coverage Factor	0.2
5th Search	Coverage Factor	0.3
		2.0
Over 5 searches, the average coverage factor =		(0.5+0.7+0.3+0.2+0.3) = 2.0/5 = C of 0.4 for five searches

- 4.3.68 In entering Appendix D-5:12 with an average coverage factor 0.4, the cumulative POD after five searches may be read off from fifth search graph line as 92%.
- 4.3.69 The projected value of the POD may be used by an SMC in deliberation of track spacing. Use of POD may also be conveniently made in describing the results of a search, or part of a search, to interested persons not familiar with search planning techniques.
- 4.3.70 The probability of detection curve is valid only when the search pattern tracks are accurately followed.
- 4.3.71 Should the target not be located within the fully expanded probability area, the SMC must decide whether to continue searching it, recalculate the probability area using alternative data, or recommend the termination of search effort.

4.4 Navigation of SAR Assets (Aviation and Maritime)

- 4.4.1 The navigational accuracy with which a search aircraft and vessels are able to reach a search area and undertake a search pattern has an important bearing on the coverage of the area and the POD. Dead reckoning navigation alone generally produces poor results. Map/chart reading can be effective but normally only over land or coastal areas in visual meteorological conditions. With the advent of the Global Positioning Systems (GPS) and the provision of satellites from a variety of nations (preventing monopoly on access and potential disruption in times of conflict) almost remove any navigational inaccuracies due to manual navigation and does not require the search asset to be within visual range of navigational markers. The GPS does not alleviate the need to keep a visual appreciation of location where possible. In areas where navigation aids are limited, search patterns should be selected so that greatest possible use is made of them. Aircraft with area navigation capabilities can be used for all search patterns in all areas. Alternatively, patterns providing a reference point or a visual navigation aid, e.g. a vessel or a smoke float should be considered.
- 4.4.2 The navigational accuracy of available search assets is a primary consideration for selecting the types of patterns to be used, particularly if the available search assets are aircraft. While the accuracy of navigation of surface craft is generally not too great a problem, aircraft present a more difficult picture due to drift from prevailing winds.
- 4.4.3 Significant errors will result from accumulated errors in turns and from wind forecast errors, especially for high-speed aircraft. Consideration must be given to selecting the type of pattern,

which gives minimum turns and maximum search leg lengths in order to reduce turning errors and to make it easier for navigation, observations and corrective action. However, there may be a limit to the maximum search leg lengths when the search area covers water surfaces with strong currents or with high survivor drift rates. In these circumstances aircraft search legs are usually limited to 30 minutes or less of flying time if the legs are oriented across the drift direction. This is to avoid the possibility of the survivors drifting from one side of a track to beyond the next search track by the time the search aircraft returns to that same general area. A more satisfactory solution to this problem is to orientate the search legs with the drift direction. Marine searching would generally orient the search legs parallel to the drift unless a barrier type search is being undertaken.

- 4.4.4 Greater search accuracy is obtained when visual, RADAR or radio navigational aids are within reception range of search assets or when aircraft/vessels are equipped with area type navigation equipment (RNAV) e.g. GPS or Inertial Navigational Systems (INS).
- 4.4.5 When dividing up the total search area into areas for assignment to individual SAR assets it should be kept in mind that elongated search areas are covered better navigationally than small square areas. When two or more search aircraft or vessels are available, elongated search areas are preferred.

4.5 Visual Search Patterns (Aviation and Maritime)

General

- 4.5.6 Search pattern factors: The selection of a search pattern is very important and should only be made after all factors have been considered. The search pattern selected should meet the following criteria:
 - a) Suitability: It should permit the search to be completed within the time limits;
 - b) Feasibility: It should be within the operational capability of the available search assets;
 - c) Acceptability: The expected result should be worth the estimated time and effort;
 - d) Safety of the search assets: Close attention should be paid to air traffic in the area of the search. Normally more than one aircraft should not be assigned to a search area segment at the same time. Multiple aircraft operating in the same search area distracts aircrew attention from the search and decreases the flexibility to respond to sightings and drop markers or flares, if required. This does not preclude an electronic search from taking place at high altitude while a visual search is done at a lower level. The SMC needs to be cognisant of vertical and horizontal separation requirements of aerial assets. In instances where multiple aerial assets are being used for a single search, aircraft tasking expertise should be sought from the JRCC Australia.
- 4.5.7 To assist with the pilot's responsibility of maintaining separation from other aircraft, the SMC may consider assigning aircraft in adjacent search area segments different search heights, the same creep direction and different start times.
- 4.5.8 Non-search aircraft can be informed about the search by the issue of a NOTAM.
- 4.5.9 Non-search aircraft can be excluded from the search area, or informed about the search activity by the issue of a NOTAM.
- 4.5.10 There is no NOTAM equivalent with the maritime search area. The SMC and vessel masters must have continual situational awareness of the search environment, the possibility of both small and large vessels transiting the area, and the need to halt or modify the search patterns to avoid collisions or dangerous situations.

-
- 4.5.11 The choice of search pattern is the prerogative of the SMC, who may elect to use only one pattern or several patterns simultaneously but in different areas. A series of search patterns may be used in sequence for the same area, e.g. track crawls, sector search. The following factors will influence the SMC's selection of search pattern:
- a) The accuracy of the distress position (non-GPS beacon, GPS beacon, GPS location, 2 or 3 point fix, dead reckoning, unknown);
 - b) The size and shape of the search area;
 - c) The number and type of SRUs available;
 - d) The en-route and on-scene weather;
 - e) The distance between search area and SRA base (transit time to search area);
 - f) The availability of navigation aids in the search area;
 - g) The size and detectability of the search object;
 - h) The desired probability of detection;
 - i) The limitations of time; and
 - j) The terrain of the area where the search will be conducted.
- 4.5.12 Careful thought is essential when considering search pattern selection and the allocation of specific SAR assets to execute these patterns. Once a large-scale search has been commenced, redeployment of search assets or changing assigned patterns becomes complex and should be avoided unless new intelligence indicates such change is mandatory.
- 4.5.13 There are six main groups of search patterns:
- a) Track line;
 - b) Parallel track (search legs are aligned with the major axis of an individual search area);
 - c) Creeping line (search legs are aligned parallel with the minor axis of an individual search area);
 - d) Expanding square;
 - e) Sector; and
 - f) Contour.
- 4.5.14 When it is known, or likely, that an emergency radio beacon (EPIRB, ELT or PLB) may be available in the target vessel or aircraft or with the survivors, an electronic search using an appropriate pattern, (e.g. track line search), should be carried out by aircraft flying at a high level. This may occur at the same time as a visual search is carried out at a lower altitude or on the surface. In planning this search the coverage and possibility of detection by the COSPAS-SARSAT system may be considered through contact with the JRCC Australia. It is also valuable to consider the location of the incident and the possibility of overflying aircraft detecting a signal.
- 4.5.15 Maritime assets may search relatively small areas. This type of search is generally very thorough and provides a greater chance that the target will be detected.

Parallel Track Search Pattern

- 4.5.16 Parallel track search patterns can be used for searches involving one or a group of search assets and are the simplest patterns available. The pilot/coxswain of a search vessel steers straight courses or search legs, each leg being one track spacing from the other.
- 4.5.17 Parallel track patterns are normally used when:
- a) The search area is large and the terrain is relatively level, e.g. desert and maritime areas;
 - b) Uniform coverage is required; and

c) The location of the target is not known with any precision.

- 4.5.18 Search legs are aligned parallel to the major axis (long side) of the individual search area. This is generally the trackline if known.
- 4.5.19 The pattern is best used in rectangular or square areas. It is a very suitable pattern for a search conducted over water. The search aircraft proceeds from one corner of the search area maintaining parallel tracks, the first of which is at a distance equal to one-half the track spacing from a side of the area. Successive tracks are maintained parallel to each other and one track spacing apart. This type of search may be carried out by one aircraft or by several aircraft following parallel tracks or each searching smaller rectangular areas separately. In a marine environment the search vessel/s will follow the trackline initially, the second leg would be off-set to one side, at one track spacing for the length of the search. The third and subsequent legs would alternate either side of the trackline until the entire area has been completed. The SMC should be aware of drift effects to ensure the target will not drift out of the search area before it is completed.
- 4.5.20 When aircraft search hours and adjacent traffic permits, turns will be conducted outside the search area boundaries as shown in Figure 4-5. This allows observer rest and crew position changes.

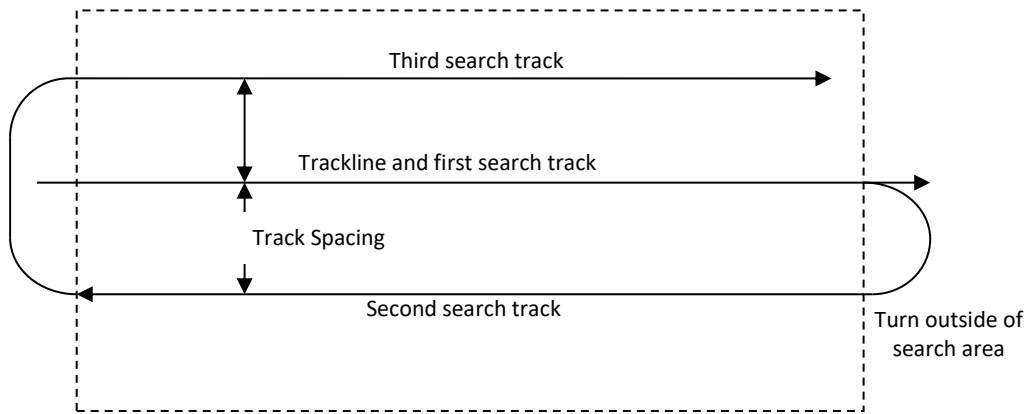
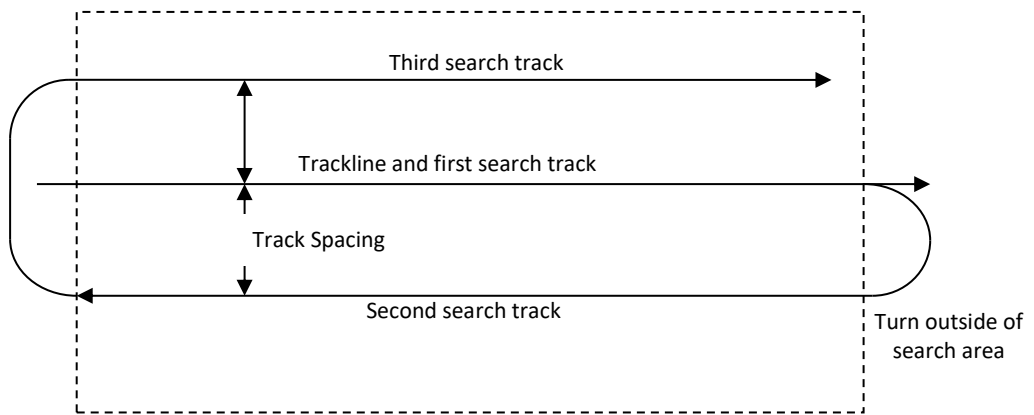

Figure 4-4 Vessel trackline search



4.5.21

Figure 4-5 Aircraft Parallel Track Search Pattern

Parallel Track Pattern Single Asset

- 4.5.22 This pattern is conducted by a single asset. The SMC will detail the area to be searched by giving depth and distance, visual reference points or latitude, longitude if the Search Asset is so capable.

Parallel Track Pattern Multi-Asset

- 4.5.23 This is based on the same principle as the single asset search, except that more than one boat is searching in line abreast, one track spacing apart. It is particularly useful when a number of search assets, fishing boats or pleasure craft are available for searching an area and can be instructed what to do by radio. The OSC will direct the search from his position with all turns and distances taken from the OSC's vessel. Aircraft would not likely be tasked to perform a multi asset parallel track search.

Creeping Line Patterns

- 4.5.24 These are the same type of searches but the legs are parallel to the short side of the search area. These patterns would be used when there is a stronger probability of the target being closer to one end of the search area. The SMC should be aware of the drift rate to ensure that the target is not drifting through the search area faster than the search assets are capable of searching.
- 4.5.25 The search asset begins the pattern at the end of the search area where the target is most likely to be. These patterns can also be used both in single and multi-asset searches.
- 4.5.26 The multi-asset creeping line pattern is used when there are five or more search assets available in a search of a high probability area for small size targets, such a person in the water. This pattern concentrates the search assets in the datum area and is structured to avoid gaps developing at the end of each sweep.
- 4.5.27 Search assets pivot on the second search assets. By the time the first, second and third vessels take up their allotted positions, the fourth and fifth search assets will have moved with the prevailing drift to position them at the top of the next sweep. This method will ensure total coverage of the search area, however, it must be borne in mind that this pattern is slower than other patterns and requires a greater degree of coordination by the OSC.

Track Line Search

- 4.5.28 This procedure is normally employed when an aircraft or vessel has disappeared without a trace. It is based on the assumption that the target has crashed, made a forced landing or ditched on or near the intended route and will be easily seen, or that there are survivors capable of signalling their position by a flashing lamp or other means. It consists of a rapid and reasonably thorough search on either side of the intended route of the target, normally at a height of 1000 to 2000 ft. during day or at 2000 to 3000 ft. at night. A track line pattern is often used as an initial reaction to a distress situation, the second, intensive phase being introduced on the failure of the track line search.
- 4.5.29 Aircraft and ships following the same route as that of the missing aircraft or ship should be asked if they are available to divert to assist in the search for the target. For ships, this will mean diverting to intercept the most probable track line of the target. For aircraft, this type of search should be regarded as additional to searches by SAR assets, as an en-route aircraft may not be entirely suitable as a search platform due to its performance, configuration, endurance, navigational capabilities or lack of observers.

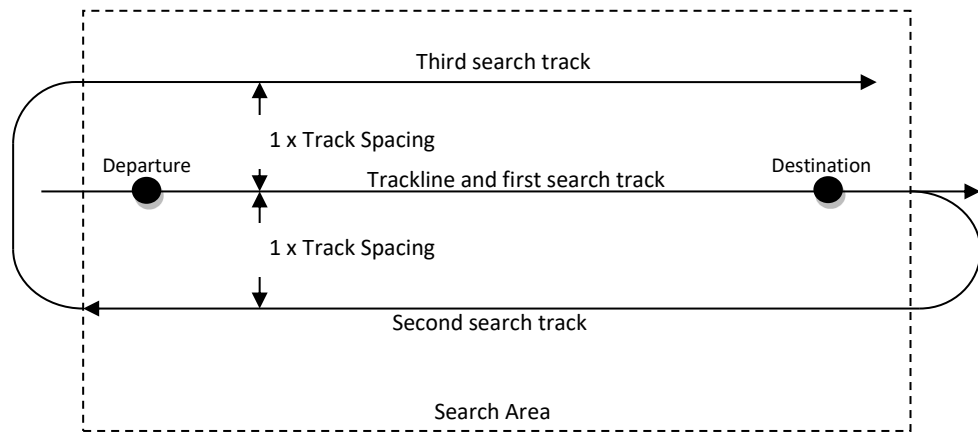

Figure 4-6 Track Line Search where aircraft is returning back along track

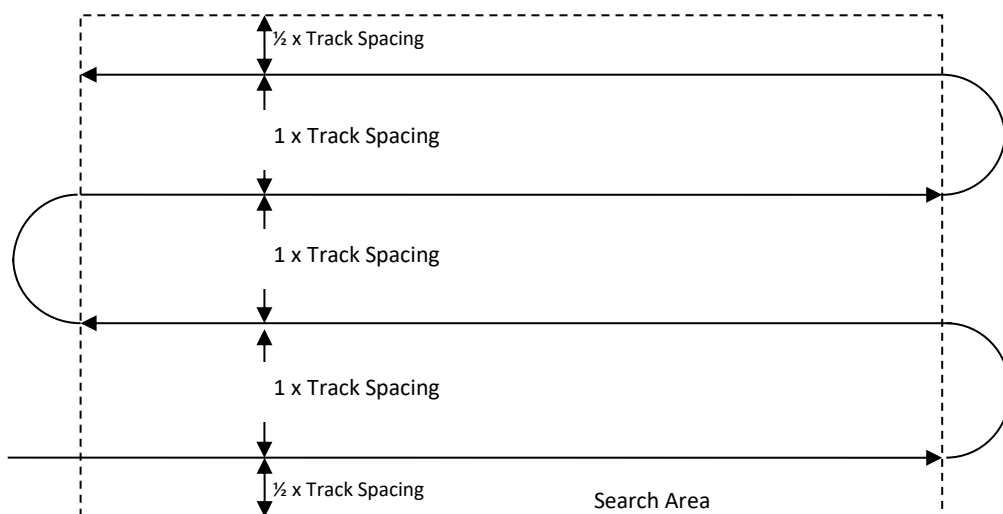

Figure 4-7 Track Line Search where aircraft is not returning back along track

Note: The first leg may be displaced 1/2 S into Search Area. Turns should be made outside Search Area Boundary.

Expanding Square Search

- 4.5.30 This procedure is referred to as an expanding square search as it begins at the reported position or most probable location and expands outwards in concentric squares. It is a very precise pattern and requires accurate navigation. It may be advisable for vessels, especially when searching for a person in the water with either an expanding square search (SS) to use dead reckoning (DR) navigation rather than more accurate navigational methods. DR navigation will minimize pattern distortion relative to the search object since it will automatically account for the currents affecting the search object's drift during the search. (Using timings for search legs rather than fixed or electronic navigation aids the search vessel and target will generally be drifting at similar rates through the search area.)
- 4.5.31 For both vessels and aircraft, if a smoke float or other highly visible, expendable object is available, it should be deployed at datum and the pattern should be performed relative to it.
- 4.5.32 Precise search pattern navigation using high-precision methods such as global satellite navigation systems will produce good patterns relative to the ocean bottom, but not relative to the drifting search object. This could allow the search object to drift out of the search area before the search facility arrives in the vicinity or during the search.
- 4.5.33 The square search pattern is used when the target is known to be in a relatively small area, no more than 15-20 NM from the start point.

- 4.5.34 The first two legs are held to a distance equal to the track spacing and every succeeding two legs are increased by another track spacing. Turns may be to the left or right, depending upon the observer positions.
- 4.5.35 For successive searches, the direction of the search legs should be changed by 45 degrees. The final track should be the same as the initial search track from the start point. The number of search legs may be 5, or, increasing by increments of 4, 9, 13, 17 etc.
- 4.5.36 Scanning should start at a distance of "S" before reaching the most probable position to avoid leaving an area not scanned near the start point. Observers should be briefed to pay particular attention to the areas outwards of each turn to avoid leaving areas not scanned.
- 4.5.37 To minimise navigational errors, the first leg is usually oriented directly into the wind

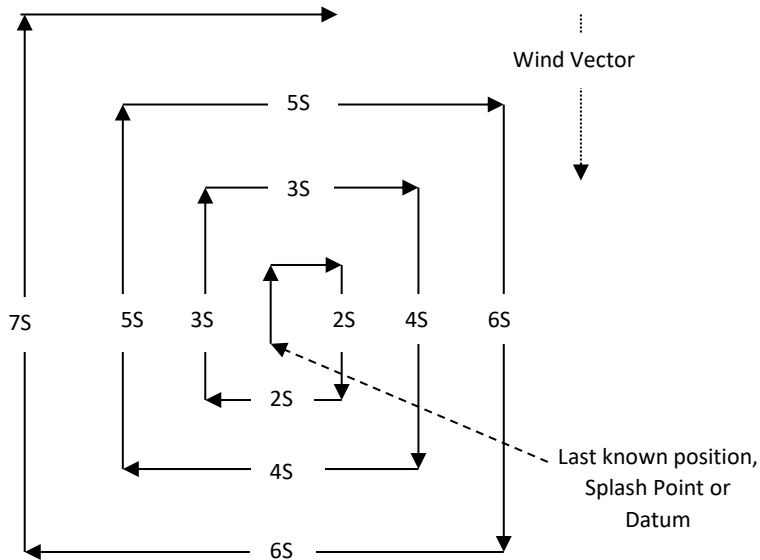

Figure 4-8 Expanding Square Search Pattern

- 4.5.38 Table 4-3 may be used to determine the number of search legs (N) and total track distance (D), given a particular radius (R) and selected practical track spacing (S), e.g.
 If R = 10NM and practical S = 2NM, then N = 21 and D = 240NM. The total track distance can then be used to determine whether a suitable SAR aircraft has sufficient endurance to effectively complete the task.

Note: The total track miles that an asset has available on search can be calculated by multiplying the effective time available on search (from Worksheet 6: actual search hours (ASH) – 15%) by asset search speed.

RADIUS (NM)	S=0.5		S=1		S=2		S=3		S=4		S=5		S=10	
	N	D	N	D	N	D	N	D	N	D	N	D	N	D
1	9	12	5	8										
2	17	40	9	24										
3	25	84	13	48	5	16								
4	33	144	17	80	9	48	5	24						
5	41	220	21	120	9	48	9	72						
6	49	312	25	168	13	96	9	72	5	32				
7	57	420	29	224	13	96	9	72	9	36	5	40		

8	65 544	33 288	17 160	13 144	9 36	9 120	
9	73 684	37 360	17 160	13 144	9 36	9 120	
10	81 840	41 440	21 240	13 144	9 36	9 120	
11		45 528	21 240	17 240	13 192	9 120	
12		49 624	25 336	17 240	13 192	9 120	
13		53 728	25 336	17 240	13 192	13 240	
14		57 840	29 448	21 360	13 192	13 240	
15			29 448	21 360	17 320	13 240	5 80
16			33 576	21 360	17 320	13 240	9 240
17			33 576	25 504	17 320	13 240	9 240
18			37 720	25 504	17 320	17 400	9 240
19			37 720	25 504	21 480	17 400	9 240
20			41 880	29 672	21 480	17 400	9 240

Table 4-3 Number of Search Legs in Expanding Square Search given Radius

Table Notes:

1. Do not interpolate.
2. Tabular values of D are based on the search aircraft completing the search at the boundary of the square area. To achieve this, the final 3 search legs of a square search pattern are of equal length.

4.5.39 Maritime surface SAR assets are not normally assigned a radius in excess of five miles.

Sector Search

- 4.5.40 This pattern may be employed when the LKP, Splash Point or Datum is known within close limits and the area to be searched is not extensive. It is simple to execute, is likely to provide greater navigational accuracy than a square search and, because the track spacing is very small near the centre, it ensures a high probability of detection in the area where the target is most likely to be located, in the centre.
- 4.5.41 A suitable marker is chosen as a datum and navigation aid on each search leg. For practical purposes, the datum may be moved a mile or two, either at the planning stage or on scene, to take advantage of a prominent landmark well suited as a navigation reference. When using the pattern over water, it is useful to drop either a visual or electronic beacon to mark the datum. Adjustment for total water current is automatic and only leeway need be separately considered.
- 4.5.42 Trained crews using an aircraft with capable electronic navigational equipment should only be used to fly this search.

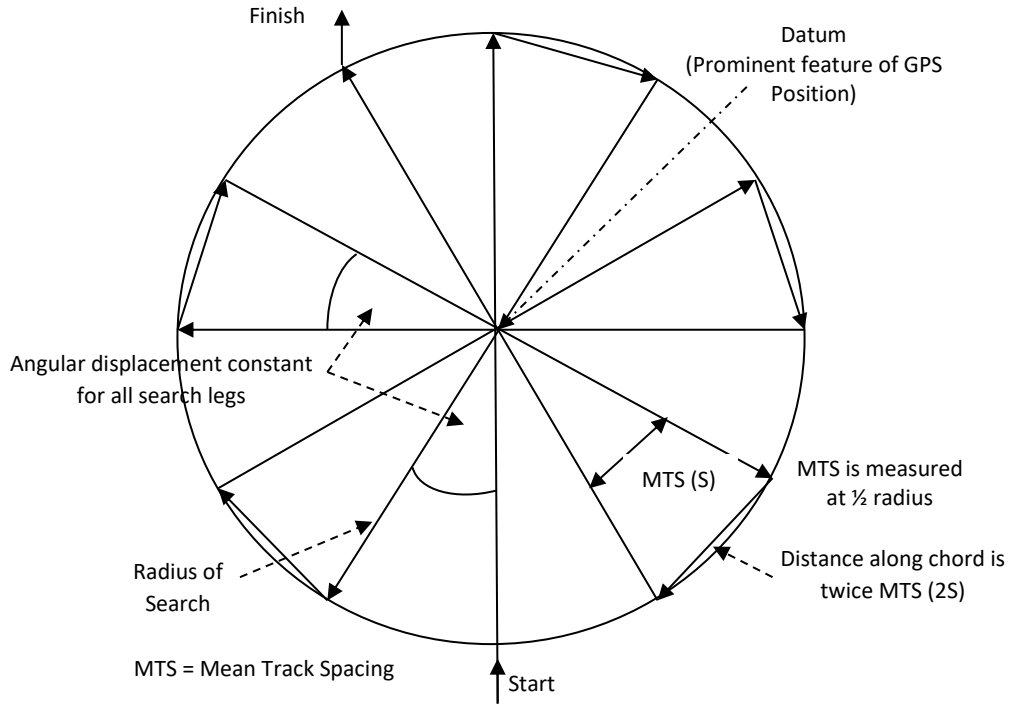

Figure 4-9 Sector Search Pattern - Aircraft

- 4.5.43 Each search leg is separated by an angle based on the maximum track spacing at the end of the legs and the search radius. For convenience, the angular displacement between each search leg and the distance required to fly the pattern for various track spacing and search radii may be extracted from Table 4-4, Sector Search Calculations, on the following page. The table has also been modified for ease in reading.
- 4.5.44 The table makes use of Mean Track Spacing (MTS) as a basis for deriving angular displacement and distance to be flown. MTS is the track spacing at a distance of half the radius of the search area from the datum. The table may also be used to determine the track spacing that can be used for a given track distance and search radius.
- 4.5.45 The search start point may be either on the perimeter of the pattern or over the datum depending on the approach track of the search aircraft and the orientation of the first leg. To keep track computation simple, the first leg may be oriented to the north but this is not essential. Successive tracks may be calculated by adding 90 degrees plus half the angular displacement to the previous track, and so on. The length of the cross leg is twice the mean track spacing.
- 4.5.46 The coverage factor, obtained using sweep width information and mean track spacing, may be used to determine the POD.
- 4.5.47 If a further sector search is necessary, it should be carried out on tracks plotted halfway between the tracks of the pattern followed during the first search:

SECTOR SEARCH CALCULATIONS (This table must not be interpolated)								
S (MTS)	1		2		3		4	
R (Radius)	Deg.	D	Deg.	D	Deg.	D	Deg.	D
5	24	90	48	45	72	30	100	30
10	12	330	24	180	36	120	48	90
15	8	720	16	375	24	270	32	210

Table 4-4 Sector Search Calculations

Table Notes:

1. Deg = number of degrees between successive legs

D = total track distance (NM) to complete the search pattern

R = Sector Search Radius

S = mean track spacing (MTS)

2. The total track miles that an asset has available on search can be calculated by multiplying the effective time available on search (from Appendix D-7 Worksheet 5: actual search hours (ASH) – 15%) by asset search speed.

Example:

An area 10 miles radius is to be searched at a mean track spacing of 3NM. From the table, the angle between tracks is 36 degrees and the total distance to be flown by a single search aircraft is 120nm. 120nm flown at 120kts will take 1 hour to search (A helicopter at 60kts would take twice as long at 2 hours).

Sector Search Pattern for a Vessel

4.5.48 For vessels search pattern radius is normally between 2nm and 5nm and each turn is 120 degrees. The length of each chord is the same of the radius (R), therefore the total track miles to complete the search area is 9R.

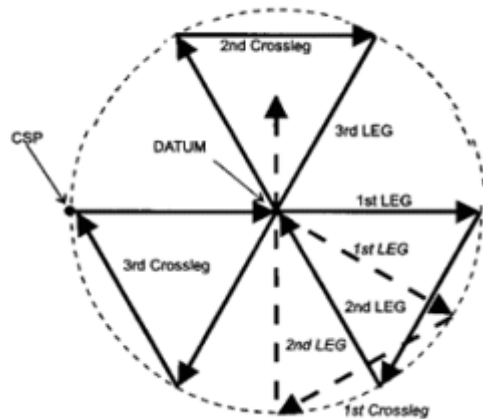

Figure 4-10 Sector Search Pattern - Vessel

Note: CSP = Commence Search Point

Aural Search by Surface Craft

4.5.49 An aural search by search vessels may also be required at night for person in water situations. Such a search is accomplished by periodically stopping all engines of the search vessel and listening for the calls for help from survivors. The sounding of a ship’s horn should precede an aural search in an attempt to attract the attention of survivors.

Note: The conduct of an aural search may be hazardous under certain conditions and will only be conducted at the direction of OSC, after consultation with the SMC. However, serious consideration must always be given to conducting this search at night for person in water situations, especially where it is thought the survivors may not have any detection aids.

Coastal Search (Islands and their Foreshores)

- 4.5.50 The searching of coastal islands and their foreshores must always be considered when they are located within the search area, or near to it. Uninjured survivors in sight of land may attempt to make landfall, however they often overestimate their physical capabilities or underestimate the distances involved (The distance to the horizon (km) calculation is $3.57 \times \sqrt{h}$, therefore a person floating in the water would have visibility out to 1.59km (0.85nm) [$3.57 \times \sqrt{0.2}$ (eye height of approx. 20cm above water level)]).
- 4.5.51 A small coral key may be visible from a distance of 6.5km, while land of 20m above sea level may be visible from 17.5km in flat sea conditions). Island foreshores may provide evidence of flotsam or debris that may further aid in SMC's search planning.
- 4.5.52 In situations where a coastal island lies directly within a search asset's track, it may be necessary to interrupt the progress of the search asset to search the island and its foreshores. Alternatively, a second search using additional search assets should be considered.
- 4.5.53 Surface craft engaged to perform this search must be suitably equipped with adequate depth sounding equipment and remain constantly aware of the dangers involved from operating near to land. If conditions allow, an aural search should be conducted in case survivors are asleep or have secreted themselves to obtain shelter. In these cases, the sounding of a ship's horn or other form of noise making may alert survivors to the search asset's presence.
- 4.5.54 Should an island fall within a high probability area or there is evidence available that may suggest survivors have reached that point, serious consideration should be given to conducting a land search. Consideration could also be given to the use of RPAS or drones to cover the foreshores and searchable areas of all islands if available. If there are conventional aircraft searching for police or if the JRCC has aviation coordination, for safety reasons drones should not be used without prior approval from the Aviation Coordinator. It is possible that with good planning drones may be suitable to be included in some searches.
- 4.5.55 When only a visual foreshore search is considered necessary, it is important that the entry and exit points the search asset take when approaching and leaving the island overlap to avoid blind spots developing. Small vessels, or aircraft, especially helicopters, capable of safely flying at low altitudes and speeds, can be used to pass close enough to the shoreline to permit careful inspection and are ideally suited to conduct island and foreshore searches. At night, an aircraft fitted with NVIS and/or EO/IR would be an advantage. Vessels engaged in shoreline searches must be aware of navigational constraints and any limitations imposed by sea conditions. The SMC should consider the possibility of survivors clinging to buoys or rocks offshore.

Contour Search by Aircraft

- 4.5.56 Contour search is used to examine mountain slopes and valleys when sharp changes in elevation make other types of search impractical.
- 4.5.57 The procedure requires that the search aircraft be flown at a selected contour level adjacent to the side of steep terrain, starting at the highest selected level. The search is started above the highest peak with the search aircraft completely circling the mountain at that level. Then the search aircraft descends a planned vertical distance while making an orbit in the direction opposite to the search (forming a figure eight), then it makes another circuit of the mountain, and so on. When there is not enough space to make an orbit opposite to the direction of the search, the search aircraft may spiral downwards around the mountain. If the mountain cannot be circled, successive sweeps at the same intervals should be flown along its side. Valleys are searched in circles, moving the centre of the circuit one track spacing after each completed circuit.

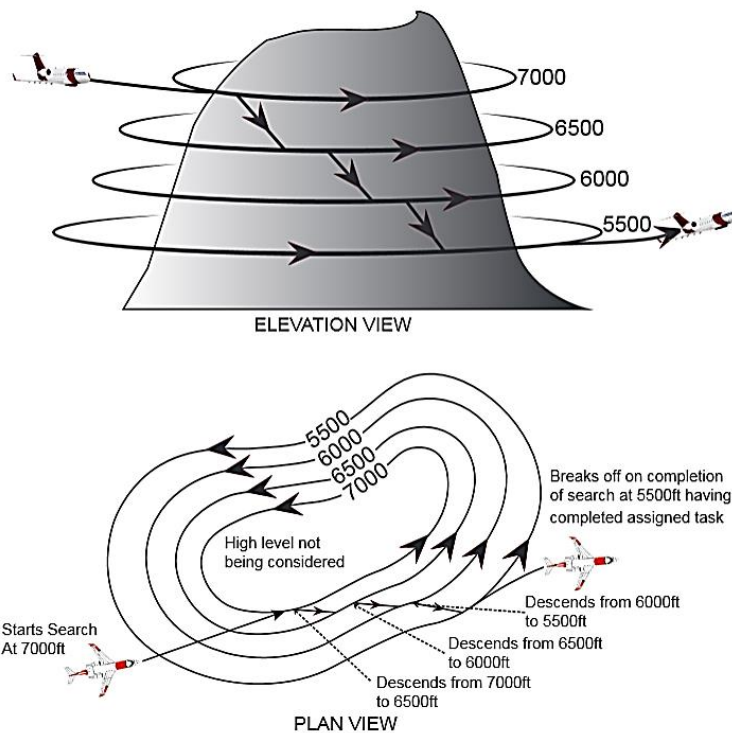

Figure 4-11 Contour Search Pattern

- 4.5.58 It is common to plan for search aircraft to descend a particular vertical distance between successive sweeps. The vertical distance between contours may be selected on a case-by-case basis after consideration of factors similar to those governing the determination of track spacing, i.e. visibility, nature of terrain, type of target etc.
- 4.5.59 A contour search may be very dangerous. Extreme caution should therefore be exercised when searching mountains and valleys. The following safety matters should be considered:
- a) The crew must be very experienced and well briefed and possess accurate large scale maps (1: 100,000 scale maps or larger are recommended);
 - b) Mountainous search areas should be assigned to multi-engine aircraft whenever possible, in the same manner that multi-engine aircraft are used over water for safety in the event of a mechanical issue;
 - c) During the search, the entire pilot's attention will be devoted to flying the aircraft. The pilot must evaluate forward terrain to avoid any hazard such as power lines, cables etc. When searching valleys, the pilot must plan ahead to ensure that the aircraft can either climb out of a difficulty or turn around, knowing at all times which way to turn in case of an emergency;
 - d) The weather conditions in the search area must be good, including both good visibility and lack of turbulence, and must be constantly checked. Flights in mountainous areas should be avoided when winds exceed 30 knots because downdraughts can exceed 2000 feet per minute;
 - e) Aircraft should not enter any valley that is too narrow to permit a 180 degree turn at the altitude flown. Searches should be flown close to one side of a canyon or valley so that the entire width may be used if a 180 degree turn becomes necessary. A similar method should be applied when making a contour search of a mountain; and
 - f) The aircraft should be highly manoeuvrable and have a high rate of climb and a small turning radius.

- 4.5.60 Orographic turbulence may be found as up-draughts on the upwind side of slopes and ridges and on the downwind side as downdraughts. The extent of the effect depends on the wind speed and the steepness of the slope. Orographic turbulence will be more intense over a rough surface.
- 4.5.61 The safest crossing of mountain peaks and ridges at low altitude under windy or turbulent conditions is downwind, where any downdraughts will be encountered after the terrain is crossed. If this is not practical, altitude should be increased before crossing these areas. Best procedure in transiting a mountain pass is to fly close to that side of the pass where there is an upwind. This will provide additional lift in case of an emergency. Maximum turning space is available and a turn into wind will be towards lower terrain. Flying through the middle of a pass may be dangerous as this allows the least turning space and is often the area of greatest turbulence.
- 4.5.62 Should it not be practical to search the entire surface of a mountainous area, a SMC may initiate plans on the basis of certain assumptions, e.g., if limited to VMC, the target pilot in a missing aircraft would neither willingly enter cloud nor descend below the lowest height at which a valley or a gap could be safely traversed. There may, on the other hand, be intelligence information to hand indicating that the target pilot in a missing aircraft did enter cloud, in which case the aircraft may be found at an elevation within the extent of the then existing cloud layer. These possibilities should be examined carefully if it is known that a pilot was flying, or intended to fly, through a valley or gap in the proximity of cloud.
- 4.5.63 To determine a probability area in such circumstances, a SMC may proceed as follows:
- Mark the contour line at a level 500 ft. higher than the highest level it is considered that the missing aircraft would have been flown, and colour all areas above this height in RED;
 - Mark the contour line at a level 500 ft. lower than the height at which the area could be safely traversed, and colour all areas below this height in GREEN; and
 - The uncoloured area will be the probability area, and, on an appropriate map, may be used as a three dimensional representation of ridges, gullies, etc. Figure 4.11 demonstrates a resultant diagram after using this procedure.

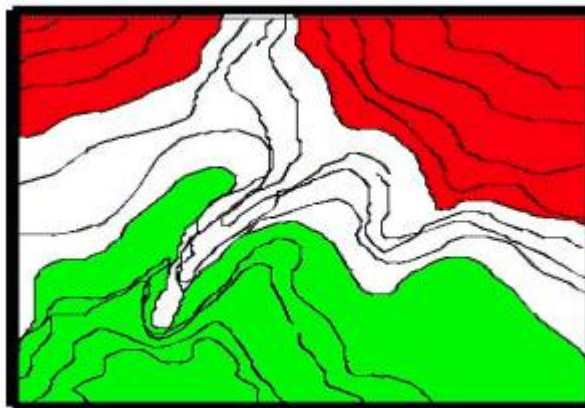

Figure 4-12 Example of Probability Area of Contour Search

- 4.5.64 Crews must be well briefed and possess accurate, large-scale maps showing the contour lines. (1:100,000 is the smallest practical scale). Crews shall be reminded to make all positioning turns away from the mountainside and to exercise extreme caution when searching valleys where climb-out or turn-around is difficult or impossible.
- 4.5.65 As with other forms of search, an accurate account of the areas actually searched is required by the RCC. The search crews should plot actual areas covered as the flight progresses. Areas that have been searched should be shaded in on a large-scale topographical map, leaving the unsearched area outlined. Where possible a GPS record of the search tracks should be downloaded at the completion of each search task and overlaid on a master map. Further information can then be added by the flight crew.

4.5.66 Only one aircraft shall be assigned to an area at any one time.

Mountainous or Rugged Terrain Searches

4.5.67 Searches by fixed wing aircraft become ineffective over certain types of terrain. Helicopters should be tasked for these areas. Individual areas may be defined by using:

- a) Squares or rectangles (using a GPS or similar to define the boundary); or
- b) Geographical areas, referenced to geographical, topographical or man-made features.

4.5.68 Points to note:

- a) An area of approximately 20 – 30 square nautical miles (65 – 100km²) is a good size, depending on the type of helicopters available and the transit distance;
- b) A number of sorties will normally be required to complete each area;
- c) The closer a refuelling point can be established to the area the better; an oval or open area in town is suitable;
- d) A Forward Command Post or Forward Field Base is very desirable; and
- e) If using non-geographical areas, i.e. squares or rectangles, GPS is required.

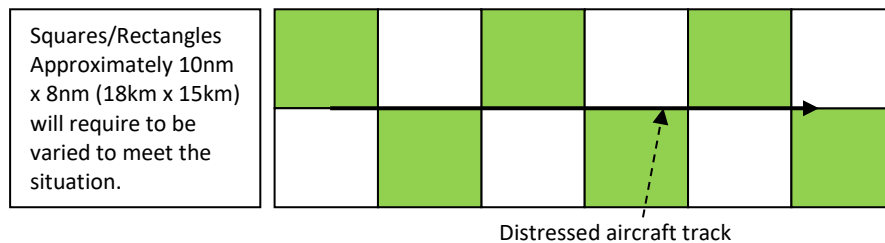

Figure 4-13 Helicopter Search Area

Line Abreast Helicopter Searches

4.5.69 Where a small area requires a saturated visual search the use of helicopters on an “emu-hop” or line abreast search is an effective search method.

4.5.70 This search is best achieved by assembling all search assets at one location for briefing by Forward Command Post/Forward Field Base personnel or the assigned On Scene Coordinator.

4.5.71 When on task, the assigned coordinator should ensure all search assets keep their position, and care is exercised with any target inspections.

Aviation and Maritime Search Considerations

Night Time Multi-Asset Searches

4.5.72 Extreme care should be taken during multi-asset searches to maintain the observers' night vision whilst working in close proximity to search lights. The operators of searchlights should always remain aware of this concern and direct the search light from a bearing right ahead to a bearing of approximately 45° to port or starboard.

4.5.73 For small targets such as a person in the water, search asset track spacing must be adjusted so that the beams of the searchlights maintain a good overlap at all times.

Drift Compensation

4.5.74 In maritime areas where there is a high drift rate, care must be taken to ensure the target does not drift out of a SAR asset's area. This problem occurs when the rate of creep of the SAR asset is less than the rate of drift of the target.

4.5.75 When this condition exists some methods of resolving the problem are to:

- a) Align the SAR assets search legs with the drift vector;
- b) Use shorter legs for the SAR asset to increase the rate of creep; and
- c) Increase the SAR asset's speed.

Irregularly Shaped Areas

4.5.76 The foregoing method of allocating aircraft assumes a regularly shaped search area. At times it is more practical to define search area boundaries by geographical features. In these situations, it is frequently impossible to set out geometrically aligned, regularly spaced search tracks. Pilots should be briefed to make every effort to conform to the standard patterns but it may be necessary, at times, to leave the execution of the search pattern to the discretion of the pilots.

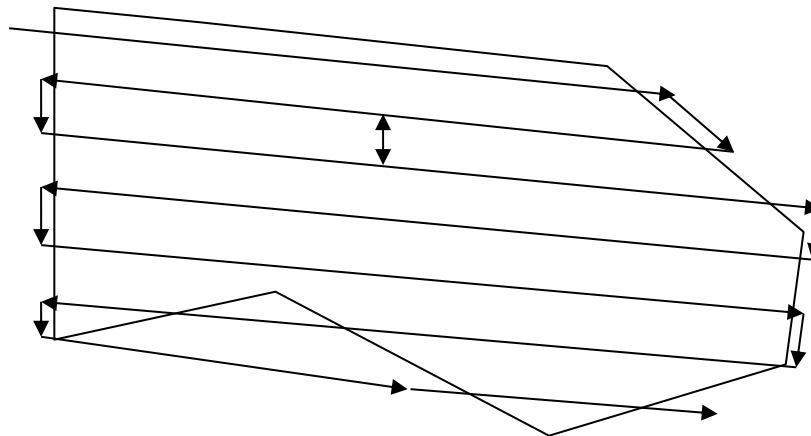

4.5.77

Figure 4-14 Irregularly Shaped Search Area

4.5.78 Some difficulty may be encountered in determining the extent of an irregular area to be allocated to any one aircraft.

4.5.79 Search effort should be calculated on Appendix D-7 Worksheet 6 in the prescribed manner and a process of estimation, based on the worksheet calculations, and, if necessary, trial and error, adopted to fit aircraft into suitable areas.

4.5.80 When allocating irregular sectors, it is good practice to allocate somewhat smaller areas than were they regular to make allowance for positioning turns and additional manoeuvres.

4.6 Flare Searches

4.6.81 Military aircraft may be capable of conducting a Flare Search at night. The procedure is appropriate to night time operations when it is known that survivors are equipped with distress signal flares. The military authority concerned will decide the practicality of such a search.

4.6.82 The search is flown at 5000 feet or below the cloud base, if lower. The crew fires a green flare every 3-5 minutes after entering the search area and at each turning point of the search pattern.

4.6.83 The frequency with which flares are fired from the aircraft should ensure that survivors could sight at least two successive flares. The survivors are expected to respond to green flares by firing their own red flares. The crew will acknowledge the sighting of the distress flares by firing a succession of green flares and switching on the aircraft's landing lights.

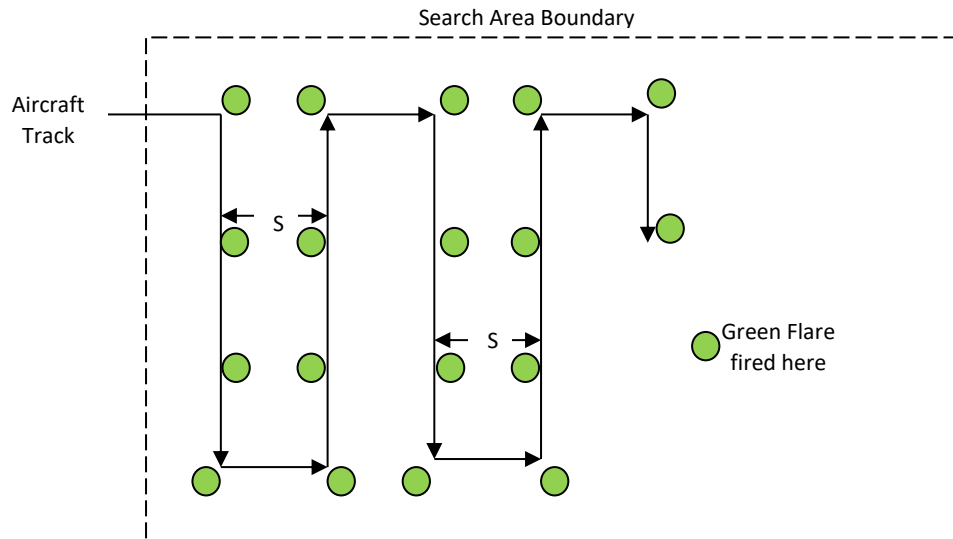

4.6.84

Figure 4-15 Flare Search Pattern

4.6.85 The spacing between adjacent tracks (S) will depend upon visibility. The quality of pyrotechnics available to survivors is usually limited and survivors are unlikely to fire flares until sighting the lights of or flares from a search aircraft. For this reason, sweep width for a flare search should be based on the range at which survivors may see the search asset. On entering a search area, search assets may turn on all possible lights and from time to time display search lights or landing lights to facilitate sighting of the search asset by survivors. However, night vision of on-board observers needs to be taken into account.

4.7 Electronic Searches

Distress Beacons

- 4.7.1 Distress beacons are carried by ships, aircraft and land parties and operate on one or more of the international distress, safety and calling frequencies. When activated to indicate a distress situation, they emit a characteristic signal. The signal serves, in the first instance, to alert to a distress situation and, during an ensuing electronic search, as a homing beacon. The equipment can be activated either manually or automatically as a result of immersion in water (EPIRB) or on aircraft impact (ELT).
- 4.7.2 The RCC shall use whatever resources are required to locate a distress beacon even if it is believed to be an inadvertent activation.
- 4.7.3 Another authority, (e.g. ACMA or the police) is not to be given a large area in which to locate a beacon. SMCs should use aircraft to isolate an area as precisely as possible, then request determination of exact location by a cooperating authority.

Beacon Types

- 4.7.4 Today's technology takes most of the 'search' out of search and rescue through the utilisation of satellites and evolved radio distress beacons. There are three types of beacons that are carried, and in some cases, are mandated by law, that can be detected by satellite.
- 4.7.5 ELT (Emergency Locator Transmitter) is the name given to an aviation distress beacon carried by aircraft, these operate on 406 MHz, with some transmitting on 121.5 MHz for final stage homing.

-
- 4.7.6 EPIRB (Emergency Position Indicator Radio Beacon) is the name for a maritime beacon. A specific feature of an EPIRB is that it should be able to float upright. An EPIRB operates on 406 MHz with some transmitting on 121.5 MHz for final stage homing. New generation EPIRBs can be hydrostatically operated at pre-determined depths, eliminating the necessity of manual activation. Float Free mountings are becoming mandatory for commercial vessels within Australian waters.
- 4.7.7 PLB (Personal Locator Beacon) is a beacon designed for land use and also operates on 406 MHz, with some transmitting on 121.5 MHz for final stage homing. New generation PLB's are becoming waterproof with limited floatation, making them popular for mariners. They are often carried by individual crew members on larger vessels in case of falling overboard.
- 4.7.8 Beacons operating on 406 MHz have no audio signal but transmit in microbursts. Transmitted data, generally, cannot be monitored or interrogated by aircraft as the signal is generated by chip as a discrete data-package. Homing on 406 MHz beacons can be achieved by using specialised airborne equipment or by homing on the beacons' supplementary low-powered 121.5 MHz transmitters. The Australian Standard for 406MHz beacons requires that beacons manufactured for use in Australia be fitted with a 121.5 MHz transmitter to provide a homing signal. AMSA Challenger CL604 aircraft and several civil SAR aircraft can home and decode 406 MHz signals.

Beacon Transmission Characteristics

- 4.7.9 The range at which a beacon may be detected varies considerably, being dependent on a number of factors:
- Surrounding terrain - the range will be extended if the transmitter is located on the top of a mountain or hill and reduced if located in a valley, on a hill-side or mountain-side, amongst trees or bushes, or in a rain forest;
 - Sea conditions can effectively limit a beacons detectability. Signals can be masked when the beacon is in the trough between successive wave crests, creating an intermittent signal that may be difficult to accurately home in on;
 - Power output of the transmitter;
 - Condition of the beacon - if a transmitter's aerial or aerial lead has been broken or disconnected, it will, if the asset is otherwise serviceable, still transmit but its range may be reduced to 1 km or less;
 - Nature of surrounding surface - the range will be reduced if the transmitter is operated in dry, sandy country unless placed on a good earth mat, e.g. a space blanket, aircraft wing, or similar reflective surface; and
 - Presence of interference - interference sources can cause beacon-like transmissions, e.g. strobe and navigational lights.
- 4.7.10 A transmitter operating over water or relatively flat country will emit a radiation pattern approximately circular in horizontal cross section. However, if activated in rough country, between trees or amongst wreckage, its radiation pattern will be interrupted by obstructions and shaped as a series of irregular lobes. Flying a track that cuts these lobes, a pilot will hear the signal while within their coverage but receive only noise or hash between them.
- 4.7.11 Depending on the aircraft's distance from the transmitter and the particular pattern of the lobes, the period during which the signal is heard will vary from a few seconds to several minutes.
- 4.7.12 It should be noted that when a beacon is placed above a water surface, lobes are formed in the vertical plane, one additional lobe for each 112 cm that the beacon is located above the water level. The presence of vertical lobes will be indicated by variations in the received signal. Regardless of aircraft heading, the signal will fluctuate, and may disappear completely, for a distance of several miles.
- 4.7.13 When a buoyant beacon is radiating in rough seas, its aerial may dip into the waves. This results in the swept tone missing a beat or two without any increase in hash. There is little discernible

effect on the radiation pattern should an aerial be bent or otherwise distorted, provided it is clear of the water.

Beacon Search Procedures

- 4.7.14 Searches to identify and locate signals from emergency beacons will normally be initiated immediately following the confirmation of the receipt of a beacon signal. Electronic searches may be supplementary to visual searches. Rescue planning must be commenced with all beacon activations.
- 4.7.15 When it is known or believed that an aircraft or persons in distress are equipped with a beacon, an electronic search at a high level should be initiated immediately. In addition to beacons designed for operation by survivors, many aircraft carry ELTs that start operating automatically when G forces reach a certain level, such as in a crash. Larger vessels are increasingly carrying hydrostatically operated beacons that activate at pre-determined depths, generally as a result of the vessel sinking.
- 4.7.16 The electronic search should not preclude the initiation of a visual search at lower levels since the success of an electronic search depends on a beacon actually radiating a signal.
- 4.7.17 When tasking aircraft to search for a beacon signal, it may be necessary to select a search pattern from one of those already described. The most commonly employed are the track line and parallel track patterns. Track spacing should take into account terrain and the height of the aircraft and Table 4-5 lists suggested maximum track spacing.

ALTITUDE AGL/AMSL ft.	MOUNTAINOUS DENSE TIMBER NM	PLAINS or DESERT NM	MARITIME NM
1000	2	10	20
5000	10	20	50
8000	15	25	60
10000	20	30	70
15000	30	60	100
20000	40	80	150
30000	50	100	180

Table 4-5 Suggested Maximum Track Spacing for Aircraft Conducting Beacon Searches

Table Note: Beacon search altitude should, initially, be as high as possible for the aircraft tasked, subject to air traffic and meteorological conditions.

- 4.7.18 Pilots should be briefed to disable the receiver squelch, if fitted, and to leave it disabled throughout the search for a beacon signal. On modern receivers not fitted with squelch control, it may be possible to use the test switch to achieve the same end.
- 4.7.19 When searching for beacon signals on 243.0 MHz over water, the track spacing quoted in Table 4-5 should be reduced by 20% due to the lesser strength of signal.
- 4.7.20 When searching over mountainous terrain, it is recommended that the track spacing approximates the lesser of that listed for "heavy timber, jungle or mountainous terrain" and the distance between ridges. The search pattern tracks should, as far as possible, be oriented parallel with the ridges.

Locating a Beacon Signal Source by Homing Devices

- 4.7.21 A number of civil and military aircraft are fitted with direction finding equipment that enables a pilot to home onto the source of a beacon signal and fix its position.
- 4.7.22 RCC staff are not required to be familiar with the equipment or to brief pilots for in-flight operation. Procedures have been developed to localise the position of a radiating beacon when homing devices are not available and the only information available are reports of beacon signals being heard.

4.7.23 A number of agencies and volunteer organisations also have hand held homing devices.

Aural Location of Beacons

4.7.24 Aural procedures are based on the assumption that an undistorted radiation pattern is very nearly circular.

4.7.25 Some guidance on the flying of aural searches for beacons is given in AIP/ERSA. Whenever possible, JRCC Australia shall individually brief pilots unfamiliar with the procedure.

Maximum Radio Signal Range Calculations

4.7.26 By using the following formula:

$$\text{Maximum Range (in NM)} = 1.2 \times \sqrt{h}$$

(Where: h = height/altitude of the receiving antenna in feet)

$$\text{Maximum Range (in km)} = 3.57 \times \sqrt{h}$$

(Where: h = height/altitude of the receiving antenna in metres)

The theoretical maximum range of the transmitter may be calculated, or for search purposes, the theoretical maximum distance at which a beacon signal may be received given the receiving antenna's height above ground level.

Note: The transmitting antenna is assumed to be at ground level.

4.7.27 The area in which the transmitter is located may be determined by plotting a circle, with radius equal to the calculated range, from the position at which the beacon was heard. The intersection of circles plotted from two or more hearing positions will result in a fix of the probable position of the transmitter.

Signal Heard, Signal Fade Plotting Method

4.7.28 From reports of "signal heard" (SH) and "signal fade" (SF) positions received from aircraft flying at a constant level, it is possible to determine the limits of a beacon radiation pattern.

4.7.29 En-route aircraft may be very helpful in this respect. They should be asked to monitor 121.5 MHz and report the positions where the signal was first heard and where it faded. Lines joining the positions at which the signal was first heard (SH) and the positions at which it faded (SF) form chords of a circle, the perpendicular bisectors of which should intersect at the location of the transmitter. When three or more position lines are obtained in this fashion and plotted, it is most likely that a "cocked hat" will be formed, the centre of which should be taken as the MPP of the beacon. An example of a two position line fix is shown in Figure 4.13.

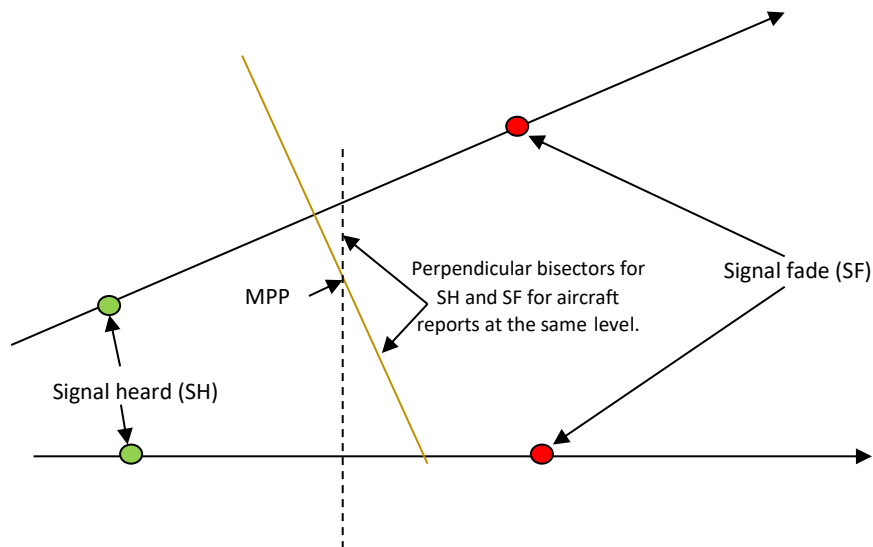

Figure 4-16 Signal Heard and Signal Fade Plotting

- 4.7.30 It is not recommended to join SH and SF positions from different aircraft due to variations in the aircraft's receiver sensitivity, and variations in altitude between different aircraft. Both these factors will alter the effective radiation pattern of the beacon.

De-tuning Method

- 4.7.31 Detailed instructions for the use of the De-tuning Method are set out at AIP/ERSA and in the SAR Manual for SAR Asset Pilots and Dropmasters.

Hill Shading

- 4.7.32 When a beacon has been localised to a general area of mountainous terrain, it is possible to eliminate smaller specific areas by flying the search aircraft over specific sectors. For example, along valleys, around isolated hills etc., noting those areas where the signal is not heard or where it cuts out sharply as a result of shading.
- 4.7.33 When a more precise target area has been isolated in this way, the de-tuning method or visual search may be employed to pinpoint the exact site.

Locating a Signal from the Ground

- 4.7.34 Ground parties may be able to locate the source of a signal using a portable Aviation Band Multi-channel AM VHF Radio. If the radio is tuned to 121.55 or 121.45 MHz and a signal is heard, it is likely that the source of the signal is within 100 metres. Progressive detuning whilst retaining the signal will locate the source of the signal.
- 4.7.35 If a beacon signal can only be heard on 121.5 MHz, the beacon is some distance away. Using a building or obstruction as a shield, if the signal is lost the building or obstruction is between the receiver and the beacon. It is also possible to use the body as a shield by holding the receiver to the chest. The signal should be weakest with the back to the signal.
- 4.7.36 To check individual craft as the source of a signal, a domestic FM/AM radio tuned to FM 99.5MHz is likely to receive the signal if placed within a few metres of the source. Also, the aerial may be removed from an Aviation VHF radio, if the signal is still received the source is very close.

- 4.7.37 Detecting a beacon by hand can be done with one or more hand-held 121.5MHz DF sets. A single device is used in a gentle sweeping action from side to side, attempting to maintain the strongest signal in the centre of the arc of swing. Slowly walking towards the strongest signal while continually sweeping from side to side will eventually arrive at the beacon. With two or more DF sets each can be set some distance apart and the apparent direction of the strongest signal plotted onto a map, the 'cocked hat' where the bearings intersect should be the most probable location of the beacon. The DF sets may have to be moved several times to take into account obstructions caused by the environment.

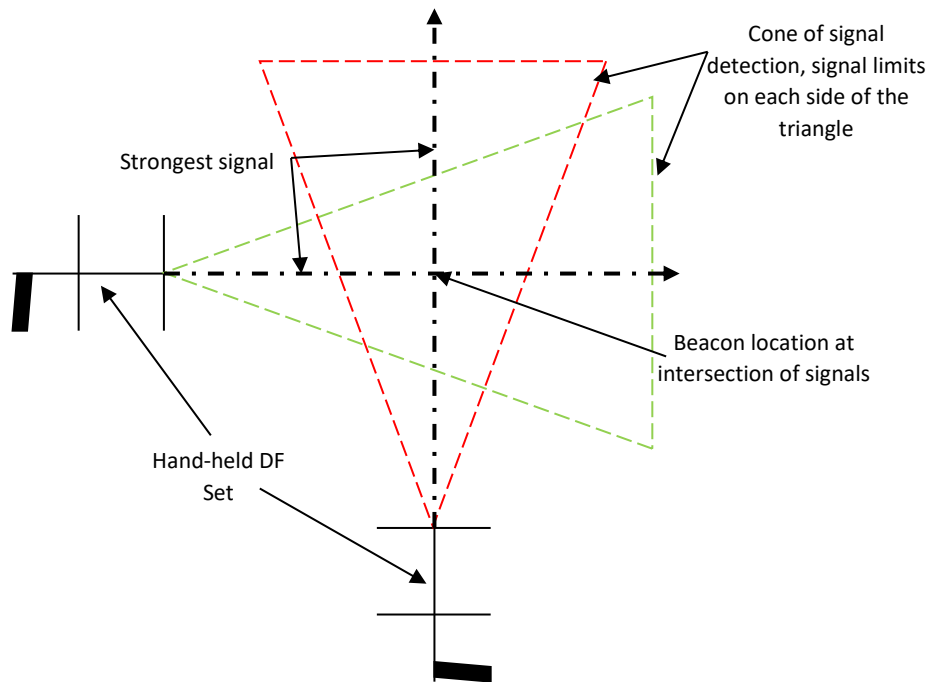

Figure 4-17 Hand-held DF Set usage

Search by RADAR

- 4.7.38 RADAR may be primarily used for maritime searches. Most available airborne RADAR would be unlikely to detect typical search objects on land except for metal wreckage in open areas such as desert.
- 4.7.39 The sweep width and track spacing to employ will depend on the type of RADAR, height, environmental clutter and noise, RADAR cross-section of the target, RADAR beam refraction due to atmospheric and operator ability. W and S should be agreed between SMC and operator.
- 4.7.40 During search planning, the aircraft sensor operator should provide a theoretical target detection range based on target type and prevailing meteorological conditions to the SMC. Detection range is a radius figure as the aircraft is at the centre of the RADAR search annulus, therefore the theoretical detection range figure should be doubled in order to determine an agreed W.

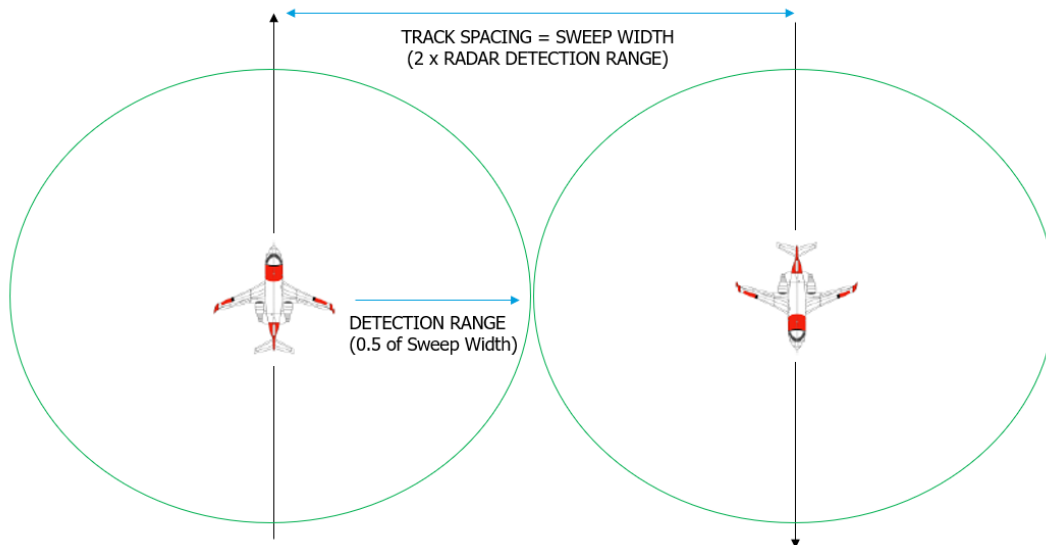

Figure 4-18 Detection Range

- 4.7.41 It should be noted that when the wave height increases to above one to two metres, the probability of detecting a small object rapidly decreases for most RADAR and consequently so does the sweep width.
- 4.7.42 RADAR minimum range is determined by the RADAR pulse width and aircraft search height. W of less than 2 NM should not be considered as this is likely correspondent with the minimum range of most modern search RADAR.
- 4.7.43 Table 4-6 provides the theoretical RADAR horizon correspondent with aircraft search height. Search heights between 500 to 1500 ft for small targets allow for visual search to be conducted concurrently with RADAR. This is a delicate balance as operations at lower altitude will also increase the occurrence of RADAR ‘clutter’ which may present as false targets which will reduce the efficiency of the search and speed of advance through the search area.

Aircraft Height in Feet	RADAR Horizon
500	27 NM
1000	39 NM
1500	48 NM
2000	55 NM
2500	62 NM
3000	67 NM
4000	78 NM
5000	87 NM

Table 4-6 RADAR Horizon Correspondent

- 4.7.44 The presence of atmospheric inversion layers should also be considered during the execution of a RADAR search. Aircraft operating below an inversion layer may experience greater than anticipated detection ranges due to a ducting effect. Conversely, operations above an inversion layer will reduce probability of detection.

Search by Infrared (IR) Devices

- 4.7.45 Infrared (IR) devices such as IR TV cameras or Forward Looking Infrared (FLIR) are passive detection systems used to detect thermal radiation. They operate on the principle of detecting temperature differences to produce a video picture. Therefore, IR devices may detect survivors by their body heat, or other search target heat sources.

-
- 4.7.46 IR devices are normally preferred for night use. Search heights, patterns and track spacings should be guided by search target size, search conditions and consultation with the search asset crew taking into consideration the capability of their equipment. Given the range of variables for IR searches, search planners and coordinators should be guided by the aircrew's expertise and plan the search accordingly with safety of the operation the priority.
- 4.7.47 Appendix F contains more details on using IR for searching by aircraft.

Night Vision Imaging Systems

- 4.7.48 Use of night vision imaging systems (NVIS) can be effective in search carried out by various types of search assets.
- 4.7.49 There are a range of factors which may influence the effectiveness of NVIS for searching, such as:
- a) NVIS type and quality;
 - b) Crew training and experience;
 - c) Environmental conditions, visibility, moonlight, cloud coverage, rain;
 - d) Level and glare effects of ambient light, natural and artificial;
 - e) SAR asset speed;
 - f) Height of the observer above the surface;
 - g) Surface conditions (like snow), sea state, type of terrain and vegetation;
 - h) Size, illumination, and reflectivity of the search object. The presence of reflective tape greatly enhances detectability; and
 - i) Types of survival equipment or light sources used by the survivors.
- 4.7.50 Glare and non-essential lighting should be minimised as much as possible within the facility where the NVIS users are stationed. This may involve opening or removing windows where practicable. Also proper scanning techniques are important for reducing the adverse effects of moonlight or artificial light sources like, lighthouses, offshore rigs, ships, navigation and strobe lights.
- 4.7.51 Visible moonlight can significantly improve detection of unlit search objects when using NVIS. Search object light sources, like strobe or similar lights, mobile telephone screens or even cigarettes, can greatly improve detection even in poor visibility conditions.
- 4.7.52 Some Light Emitting Diode (LED) lighting systems, clearly visible to the naked eye, fall outside the combined visible and near-infrared spectrum of NVIS and therefore will not be visible to aircrew using NVIS. This may present a hazard where LED lighting is used for surface obstacles. Emergency or other equipment fitted with LED lighting used by survivors may also impact detectability using NVIS.
- 4.7.53 Given the range of variables for NVIS searches, search planners and coordinators should be guided by the aircrew's expertise and plan the search accordingly with safety of the operation the priority.
- 4.7.54 NVIS searches by air can be enhanced by the support of surface ground units (land or marine).
- 4.7.55 Appendix F Aircraft Electronic Night Search Guidance contains more details on using NVIS for searching by aircraft.

4.8 Aviation and Maritime SAR Asset Selection and Characteristics

Overview

- 4.8.1 The selection by SAR staff of available SAR assets to be used in SAR operations should take into account the following considerations:
- a) The need to reach the distress scene quickly; and

-
- b) Suitability for at least one of the following operations:
 - i) Provision of assistance to prevent or lessen the severity of accidents;
 - ii) Conduct of a search, primarily by air but with the assistance of maritime or land assets as required;
 - iii) Carriage of supplies to the scene of an accident and, if necessary, delivery of supplies; or
 - iv) Execution of a rescue, (by marine and land assets or by helicopters; and as required fixed wing aircraft to provide guidance to assets or to relay communications).
- 4.8.2 In coordinating a search, the SMC, as guided by local procedures, may charter, arrange or request the provision of suitable aircraft or resources. JRCC Australia can assist with advice on suitable aircraft for SAR operations (see Volume 1, Chapter 1.1.15, Requesting JRCC Australia Assistance).

Aviation Assets

- 4.8.3 Many types of aircraft will be suitable as SAR assets with little or no modification.
- 4.8.4 However, care should be taken to ensure that, even in an emergency, safety of flight is the primary consideration and should never be compromised. The normal operational and technical limitations of an aircraft, as well as the qualifications of the crew, should be carefully noted by the SMC. SMCs must ensure they are cognisant of the factors relating to the aircraft and crew that may compromise the conduct of the SAR mission.
- 4.8.5 Some specialist SRUs that have undergone training from JRCC Australia are organised in Tiers and can be fixed wing aircraft or helicopters. The tiers relate to the capabilities and training of the aircraft and crews. Aircraft should be used where the tier relates to the capability required for the task with due regard to responsiveness and availability. Tier capabilities are detailed in Appendix D-9, Table D-9:1. SRUs are strategically located around Australia as shown in Appendix D-9, Figure D-9:1, 9:2, 9:3 to ensure the best coverage of the area of responsibility.
- 4.8.6 When chartering aircraft for use as SAR assets, SAR staff shall, whenever practical and effective, select aircraft from trained SAR/Emergency operators including;
- a) Search and Rescue Assets (SRAs); and
 - b) Police and State Emergency Service aircraft.
- 4.8.7 Advice on suitable aircraft can be obtained from JRCC Australia (see Volume 1, Chapter 1.2, Requesting JRCC Australia Assistance).
- 4.8.8 If additional aircraft are required, call out could be made according to the following priority bearing in mind suitability, location and availability:
- a) Domestic commercial aircraft,
 - b) Customs aircraft,
 - c) ADF aircraft,
 - d) Scheduled Regular Public Transport (RPT) aircraft, and
 - e) Private aircraft.
- 4.8.9 When the circumstances are appropriate, SAR staff may seek assistance from foreign aircraft.
- 4.8.10 Private aircraft may be used when so situated as to more readily effect the saving of life, operated by crew having particularly valuable local knowledge of the area to be searched, or when no other commercial aircraft are available.
- 4.8.11 As a general rule, slow aircraft or aircraft capable of reducing speed to 100 - 150 knots are most efficient for visual searches. Small and partially hidden targets are easily missed at higher speeds and faster aircraft may be subject to operational limitations making them unsuitable for low-level flights.

-
- 4.8.12 Nevertheless, fast and or highflying aircraft also play an important role in search operations, for instance when these aircraft carry out:
- a) An electronic (radio) search to home on distress signals; and
 - b) An exploratory sweep of a large search area simultaneously with a search by a slower aircraft flying at lower levels, a method that is particularly effective in maritime or other flat and unobstructed areas.
- 4.8.13 The suitability and efficiency of an aircraft for search, support and rescue operations will depend on which and how many of the following desirable features it possesses:
- a) Operational characteristics:
 - i) Safe low-speed and low-level flight capability;
 - ii) Short take-off and landing (STOL) capability;
 - iii) Sufficient range to cover the area, with due regard to the location of redeployment bases;
 - iv) Manoeuvrability, especially for searches in mountainous areas; and
 - v) Payload capacity.
 - b) Equipment:
 - i) Suitable navigation and instrument flying aids;
 - ii) Radio equipment capable of receiving and homing on emergency radio signals; and
 - iii) Adequate communications equipment;
 - c) Availability of good observation posts;
 - d) Suitability for the delivery of supplies, emergency equipment and personnel; and
 - e) Facilities for the treatment and carriage of survivors.
- 4.8.14 The SMC shall select aircraft for use as SAR Assets after consideration of the following factors:
- a) Type of search necessary;
 - b) Type of terrain;
 - c) Type of navigation involved;
 - d) Need for dropping supplies;
 - e) Disposition of aircraft with respect to search area;
 - f) Crew experience and familiarity with the area;
 - g) Weather conditions at and en-route to search area; and
 - h) Rescue considerations.
- 4.8.15 Aircraft not equipped with radios should not be used on SAR operations except as a last resort.
- 4.8.16 Fast, high flying aircraft equipped with homing and or direction finding equipment that have the operational flexibility to descend to low level for final search are recommended for beacon searches.
- 4.8.17 Seaplanes and amphibians are useful for search or for carrying supplies and personnel over water. Their use as rescue assets or carriers of personnel is limited to operations in lakes and river areas, or sheltered waters and bays. Under favourable weather and sea conditions, suitable seaplanes may also be used for rescue operations in protected waters, e.g. large lakes, bays, shore areas etc. Rescue operations on open water or at sea are generally only feasible for large seaplanes designed for rough-water work.
- 4.8.18 Helicopters are particularly useful SAR assets as their slow speed and ability to hover make them suitable for search as well as rescue operations, particularly where small targets are sought or close scrutiny of terrain or sea is required. They also have the ability to land in a confined area and, in some instances, to operate from some vessels.

-
- 4.8.19 Some helicopters are fitted with winches, floats or equipped for flight in instrument meteorological conditions (IMC) and at night giving them an added advantage for search and rescue response. Turbulence, gusting winds and icing are conditions that the SMC should consider when determining helicopters as appropriate SAR assets.
- 4.8.20 Ship based aircraft operate with great flexibility at sea because they have the advantage of a well-equipped and mobile base.
- 4.8.21 Where terrain and vegetation is such that a contour search is necessary, preference should be given to:
- a) Helicopters;
 - b) High-performance short take-off and landing (STOL) aircraft; or
 - c) Light, manoeuvrable twin engine aircraft.
- 4.8.22 Where possible, single engine aircraft should be restricted to areas where the terrain would permit forced landings.
- 4.8.23 When possible, consideration should be given to engaging aircraft capable of carrying at least four observers in order to permit rotation and rest. Observers are generally supplied by the State Emergency Services in most states/territories.
- 4.8.24 Where possible, landing sites should be as close to the distress scene as possible. The landing area selected should be clear of loose articles that may be blown into the air by the rotor downwash. On beaches, it is best to use the water's edge to form one side of the landing area. Communications should be established with the aircraft before its arrival and the pilot briefed on the landing site. If the pilot is unfamiliar with the location, a description of the area using large geographical features may need to be passed. If possible, a number of people should be deployed to secure the area before the aircraft arrives so that no one enters the landing area until the rotors of the aircraft have stopped or the pilot indicates that it is safe to do so. If the landing area is in a populated area, extreme care should be taken to ensure that no children run toward the aircraft once it has landed. When communicating with the aircraft, it is important to inform the pilot of any obstacles in the immediate area. This is especially applicable to wire strung between trees and power lines as these types of obstacles are difficult to see from the air and present a danger to the safe operation of the aircraft.
- 4.8.25 Fixed wing aircraft that can land close to a distress site can speed up the evacuation of survivors rescued by helicopter, rescue party or other means.
- 4.8.26 All flights for search and rescue purposes are to be planned and undertaken in compliance with Civil Aviation Regulations (CARs) and Civil Aviation Safety Regulations (CASRs). In the case of a SAR event where safety of life is at stake and exemptions from regulatory requirements maybe necessary and appropriate for the pilot to undertake the mission, the SMC shall review with the pilot all possible risk factors. It is the pilot's responsibility to ensure that dispensations are obtained from those officers holding the power to delegate under CARs and CASRs.
- 4.8.27 It is the SMC's responsibility to provide a complete brief of the situation, including any hazards such as adverse weather or conditions, to the pilot so that a pilot can make an independent decision to become involved in the incident dependent on aircraft capabilities and their own competence.

Australian Defence Force Aviation Assets

- 4.8.28 The RAAF maintain one aircraft on SAR standby for support to any ADF SAR event that may occur. This asset can be requested for DACC 2 tasking through JRCC Australia and HQJOC. The SMC should plan on a minimum response time from receipt of orders to take off of three hours and a maximum of twelve. Response times will vary due to the availability of SAR qualified crews and the location of the SAR stand-by aircraft. Often the response will prove more rapid than indicated by these guidelines but planning should be predicated upon these times.

- 4.8.29 RAAF P-8A and C-130J aircraft maintain SAR standby with notice to move at no longer than 12 hours. The response aircraft and location is dependent on effects requested and operational or maintenance requirements. The Joint Operations Room (JOR) will act as the POC for information regarding the RAAF standby aircraft through the AOC.
- 4.8.30 Other military aircraft suited to civil SAR operations may be available subject to HQJOC approval.
- 4.8.31 Stocks of droppable supplies are held at various RAAF aerodromes.

Control of ADF Aircraft

- 4.8.32 RAAF aircraft assigned to SAR operations coordinated by the RCC will always remain under ADF Operational control. In addition to normal service channels, ADF authorities may exercise operational control of SAR aircraft through the Defence Communications Station Australia (DCSA). DCSA is located in Canberra but has transmit and receive nodes in Exmouth, Darwin Townsville, and Riverina. DCSA provides Voice Contact Nets (VCN), discrete nets and telephone patch facilities on HF radio voice channels. Control of ADF aircraft may also be exercised using SATCOM, or Satellite phone, depending on the aircraft fit.

Customs and Border Force Aircraft

- 4.8.33 An SMC may seek assistance from Customs aircraft through JRCC Australia. JRCC Australia will request assistance in sourcing aircraft through Customs Operations Centre. Where a specific type of search is required, e.g. RADAR or night, JRCC Australia will consult with Customs and the contracted provider to ascertain the best response.

Maritime Assets

- 4.8.34 Search operations are generally best carried out by aircraft while rescue is best carried out by helicopter, marine craft or land assets. However, it will sometimes be necessary to use marine craft or land assets for some search efforts, particularly when weather conditions prevent or hamper air search, when the location of the distress scene is known with reasonable accuracy, or the location is remote and non-aviation assets are best placed to render assistance.
- 4.8.35 The speed of marine craft is usually their maximum speed possible under the prevailing sea conditions. Generally, small boats search at 10–20kt and larger vessels search at 10–30kt. At these speeds, excellent coverage for small targets is possible. However, the area that can be searched is limited due to the low level of the vessel and the earth’s curvature. Appendix D-5, Table D-5:3 & D-5:4 provide uncorrected visual sweep widths for visual search over water at eye heights of eight and fourteen feet and from the height of a merchantman’s bridge.

Category	Abbreviation
Rescue boat - short-range coastal and/or river craft	RB
Rescue vessel - long-range seagoing craft	RV

Note: The boat/vessel’s speed may be inserted, e.g. RB (14) or RV (10).

- 4.8.36 The abbreviations listed in the table above may be used when referring to vessels made available for SAR purposes. The SMC must also be aware that many police and volunteer rescue vessels will use their name as part of their call sign.
- 4.8.37 Rescue vessels can participate in operations at considerable distance from their base. Their main design requirements are good manoeuvrability, seaworthiness, long range, relatively high speed and sufficient size to accommodate survivors and equipment. Naval vessels, police vessels, offshore lifeboats, seagoing tugs, customs and pilot launches and patrol boats are of particular value because of their special equipment, including communications equipment, and trained personnel.

-
- 4.8.38 Generally, the strategy for sustenance and rescue of survivors of accidents in oceanic areas will depend upon aerial supply drops and or deployment of parachute rescue personnel pending rescue by ship or helicopter.
- 4.8.39 Rescue boats such as lifeboats, patrol boats and crash boats are short-range vessels capable of operating a limited distance off shore in good sea conditions. Pleasure craft, yachts or rigid inflatable boats fitted with an outboard motor could also be used provided they carry appropriate equipment.
- 4.8.40 Other sources of maritime assistance may include:
- a) Naval vessels;
 - b) Customs vessels;
 - c) Merchant vessels;
 - d) Fishing vessels;
 - e) Police vessels;
 - f) Volunteer marine rescue groups e.g. Volunteer Coast Guard;
 - g) Harbour craft, ferries, pilot launches and tugs;
 - h) Oil drilling rigs; and
 - i) Offshore oil industry support vessels.

Naval Vessels

- 4.8.41 When available, it is usually preferable to use naval vessels for SAR operations. The training and discipline of naval crews, communications fits and other specialised equipment with which the ships are fitted makes naval vessels eminently suitable for SAR operations. Some naval vessels can also be more freely used for combined aircraft surface vessel search operations than merchant vessels. In the event of a major operation a navy vessel may be appointed Coordinator Surface Search and coordinate the activities of other vessels.

Customs Vessels

- 4.8.42 Customs vessels are also patrolling the approaches to Australia and, where available, can be used to assist with SAR. In a similar way to Customs aircraft, an SMC may request the assistance from Customs vessels through JRCC Australia.

Use of Merchant Shipping

- 4.8.43 Some ships do not maintain a continuous communication watch and consequently must be alerted by means of an automatic alarm system. As this system is traditionally employed only for emergencies involving the safety of human life, the decision to request its use must be made advisedly and responsibly. Actual requests for use of the automatic alarm shall be limited to genuine emergencies.

-
- 4.8.44 Knowledge of the positions of merchant ships is of considerable value in SAR operations as merchant ships are often the nearest means of rescue during an incident off shore. The International Convention for the Safety of Life at Sea (SOLAS) contains an obligatory provision for the captain of a vessel to proceed with all speed to the assistance of persons in distress at sea, provided the safety of his ship or crew is not compromised. At all times the safety of the vessel and crew is the responsibility of the master and RCCs should ensure this responsibility is not compromised. In a distress situation, where doubt exists as to a vessel's intentions, the master should be requested to advise his intentions and confirm that he is responding. Given that a master is not obliged to respond to situations that are not distress, during these situations the master should be requested to divert and assist if practicable. When vessels are known to be proceeding to assist, it is incumbent on the RCC to ensure that only the most suitable vessel or vessels are used and to release other responding vessels as soon as possible.

Equipment for Marine Craft

- 4.8.45 In the case of oceanic SAR operations, it is desirable that the ship(s) used are fitted with basic equipment appropriate to the task: navigation aids, communication equipment and life-saving and rescue items, (e.g.: inflatable life rafts, signalling devices, line-throwing apparatus, non-sparking boat hooks, rescue baskets, litters, boarding ladders and scrambling nets).
- 4.8.46 Some larger merchant vessels and all service ships will possess equipment for rescue operations. However, additional assistance and supplies, particularly medical, may be required to sustain survivors until they can be landed at a point of safety or transferred to an evacuation vehicle.
- 4.8.47 Depending on the distance from the coast, inshore rescue craft may be available to assist and will be coordinated through the State or Territory Police.

Land Search Facilities

- 4.8.48 Search by land facilities alone is usually impractical for large search areas but it can be conducted in most weather conditions and can provide complete coverage of a confined area that cannot be thoroughly searched from the air. Land parties are also critical in operations where the search is carried out from the air and rescue by land facilities.
- 4.8.49 Police authorities in all State/Territories undertake the responsibility for coordination of land search.
- 4.8.50 The need for coordination between land rescue assets and search aircraft should be considered, and plans should cater for the need for two-way radio communication. There may also be a need in remote areas to keep land assets supplied with fuel, water and food by means of airdrops.
- 4.8.51 When the survivors are located, the SMC should liaise with the police commander with a view to expediting the return of survivors to a place of safety. Consideration should be given to aircraft relay and the use of suitable motor transport: ambulances, four-wheel drive vehicles, buses, etc.
- 4.8.52 Specialist police and military land parties are equipped with material useful to the SAR role. It is desirable that land SAR assets be equipped with basic navigation aids, two-way communication equipment, sufficient clothing, medical supplies and rations to reduce the need for air drops and specialist equipment appropriate to the asset's particular role.
- 4.8.53 Details on land searching is contained within this manual.

4.9 Aviation and Maritime Search Asset Allocation

Introduction

- 4.9.1 Before committing resources to an intensive search, an evaluation should be made of the total search effort required and the contribution that may reasonably be expected from each search asset.

-
- 4.9.2 When assessing available search capacity, care must be taken not to over- estimate the capability of assets with respect to:
- The time that a particular aircraft and its crew can spend in a search area or the capability of the observers to remain effective over long periods of flight time.
 - The time that a particular vessel and crew can spend in a search area or the capability of the crew to remain effective over long periods of cruising time. This is very relevant in poor sea conditions and where there is significant distance to the search area.
 - The time that any land search team can spend in the search area and remain effective. Weather, terrain, distance to search area and vegetation has a large impact on this capability.
- 4.9.3 Failure to make a sound estimation of these factors may result in one or more of the search assets being unable to complete its allocated task and the efficiency of the entire effort being seriously compromised.

Aircraft Capability

- 4.9.4 Search aircraft are expected to comply with the rules for navigation as stipulated in AIP or the appropriate military documents, including limitations on crew times and navigation.
- 4.9.5 Guidance on the limitations on search time for Defence crews should be sought from the relevant controlling authorities. CARs, CASRs and CAOs govern civil operations.
- 4.9.6 As a general principle, search aircraft of the smaller variety should be planned in such a way that a rest period on the ground is possible after about two hours of searching.

Calculation of Search Time Required

- 4.9.7 There is a simple but important formula that should be used to quickly calculate “search ability” and thus gives practical answers to these typical questions:
- How long will it take to search the whole area?
 - I’ve got 6 hours, how much of the area can I search?
 - How many assets will I need to cover the search area?
 - We’ve got 5 hours and 4 boats, what track spacing must I use?
 - We’ve got to cover the area by 1600 hrs, how many craft will I need?
- 4.9.8 The factors to be considered are:
- The area to be searched in square nautical miles (km²)
 - Time in hours
 - Number of assets
 - Velocity of the search assets in nm (km)
 - Track spacing in nautical miles (km)

Note: If any four are known then the fifth can be calculated using the formula:

$$A = T (\text{Time}) \times N (\text{Number}) \times P (\text{Pacing/velocity}) \times S (\text{Spacing})$$

- 4.9.9 Example 1: How much area can be searched with 3 aircraft flying at 100kts in 3 hours at a track spacing of 2nm?

$$A = T \times N \times P \times S$$

$$A = 3\text{hrs} \times 3 \text{ aircraft} \times 100\text{kts} \times 2\text{nm}$$

$$A = 1800\text{nm}^2$$

- 4.9.10 Example 2: How long will it take to search an area of 2000nm² with 4 aircraft flying at 90kts and a track spacing of 3nm?

$$T = A \div (N \times P \times S)$$

$$T = 2000\text{nm}^2 \div (4 \text{ aircraft} \times 90\text{kts} \times 3\text{nm})$$

$$T = 2000\text{nm}^2 \div 1080$$

$$T = 1.85\text{hrs (1hr and 51 minutes)}$$

- 4.9.11 If diverting from the assigned pattern track to investigate a sighting, the search asset must fix its position with care. This is to ensure if the sighting is not the target, the search asset can return to and resume the assigned search from the position at which it diverted.

Calculation of Search Time Available

- 4.9.12 When evaluating the search time available from search assets, certain factors must be taken into account, where applicable:
- Total endurance;
 - Transit time;
 - Necessary fuel reserves at final destination;
 - First and last light at departure and destination aerodromes, unless flight:
 - Is permissible and practical under Instrument Flight Rules (IFR); or
 - Night Visual Flight Rules (VFR) operation is possible;
 - Weather conditions in the search area, and destination points, and any requirement for holding fuel or alternate aerodrome for aircraft.
 - Any other operational limitations; and
 - Investigation time while on search provides an allowance for investigating sightings and navigating turns at the end of search legs. It is normally 15% of the time available but may be increased where terrain or conditions dictates. This investigation time is signified by the letter Z.
- 4.9.13 In most cases, time in transit to the search area may be calculated using speed and the distance between the points of departure and destination and the mid- point of a search area.
- 4.9.14 For aircraft, when wind speeds are high, it may be advisable to compute a ground speed for use in transit-time calculations. This is especially appropriate for aircraft with low TAS. In a situation where an aircraft will depart from an aerodrome on one side of its allotted area, conduct its search, then recover to an aerodrome on the other side of the area, if the tracks are aligned with or against the wind direction, calculation of ground speeds is proper.
- 4.9.15 Fuel reserves shall comply with current regulations for the category of flight. The variable reserve allowance for IFR operations is not applied to the time spent in a search area (i.e.: it is only applied to the transit times).
- 4.9.16 Operational factors may limit the search time available from a specific aircraft, examples being the time at which an aircraft will become available, distance from mandatory servicing facilities, and other commitments of the operator that may require the return of an aircraft at a particular time.

Investigation Time

- 4.9.17 A search asset may sight objects that require investigation; therefore an allowance for the time taken to investigate must be made. The basic allowance is 15% of total time available in the search area, but the SMC may decide to increase this figure. The number of sightings investigated by previous search crews will influence any such decision. These, in turn, will be influenced by the nature of the terrain, the amount of flotsam on the sea etc. Over heavily timbered,

mountainous terrain, the allowance may need to be as high as 50% of total search time. This investigation time is signified by the letter

Effective Search Time

- 4.9.18 Effective search time is the resultant of the actual search hours (ASH) available minus the investigation time.
- 4.9.19 After making allowance for "investigation time", it may be convenient to convert the effective search time to an equivalent time at 120 kt before calculating the size of the area to be allocated to any given aircraft.

The conversion is made by using the formula:

Example: If an aircraft can be in the search area for a total time (ASH) of six (6) hours at a TAS of 180kt and 15% is allowed for target investigations, then 5.1 (6 hrs - 15%) hours may be planned for actual searching. The equivalent time at 120kt would be:

$$\begin{aligned} T \text{ (Hours at 120kts)} &= \frac{180 \times 5.1}{120} \\ &= 7.65 \text{ Hours} \end{aligned}$$

4.9.20

When obtaining data about aircraft availability, special consideration should be given to the speed at which the aircraft will be flown whilst on search. In general, to provide for optimum scanning by observers, search aircraft should fly as slowly as possible. There are, however, other aspects to be considered, particularly the time available for search and the need to cover the area expeditiously. It may be beneficial to discuss these interacting considerations with operators. Some aircraft operate in excess of 120kt when on search; although this is less than optimum, logistic considerations may dictate the use of these speeds.

- 4.9.21 When the track spacing to be assigned to each aircraft has been decided, the area each aircraft can cover may then be calculated from the formula: $A = TVS$.

Comparison of Search Time Required and Time Available for Search Aircraft

- 4.9.22 Comparison of the search time required with that available, (both denominated at 120kt), will reveal whether the aircraft resources available are enough, too much or too little.
- 4.9.23 At this point, a critical decision related to aircraft allocation may be made. The time required for search is directly related to track spacing; track spacing, in turn, is directly related to search height. It is feasible, therefore, that despite first indications that insufficient resources are to hand, timely coverage of the whole search area could be achieved by the available aircraft for the sake of a higher-than-optimum search height.

Sufficient Search Time for Search Aircraft

- 4.9.24 Having calculated the time available from each search aircraft and converted it to time at 120 kt, it is possible to calculate the area that each aircraft can cover, and to allocate a specific sector of the area to each aircraft.
- 4.9.25 Various factors may influence the positioning of search aircraft in the area. These include:
- The type of aircraft;
 - Time of arrival in the search area;
 - Supply dropping capability;
 - Navigation capability;
 - Suitability to a particular type of search;
 - Search height, or speed limitations; and
 - Location of recovery aerodrome.

- 4.9.26 When the search area is shaped as a trapezium, (as it usually is in a "last report/missed report" SAR situation), it is simplest to start allocation from the wider end of the area, as follows:
- The distance D1 should be measured;
 - Consider the area that can be searched by the first aircraft to be allocated;
 - Divide this by the distance D1, and thereby determine the width of the resulting rectangular search area. This width may then need to be adjusted so that the number of legs to be flown will be complete;
 - Consideration should also be given to the location of the departure and recovery aerodromes relative to the search area. If they are on opposite sides of the search area, the number of legs should be odd, if on the same, even. In any case, this relationship may require a further adjustment to the number of legs to be flown; and
 - By multiplying the number of legs by the track spacing, the width of the area to be assigned may be deduced. Repeat the procedure for areas A, B, C

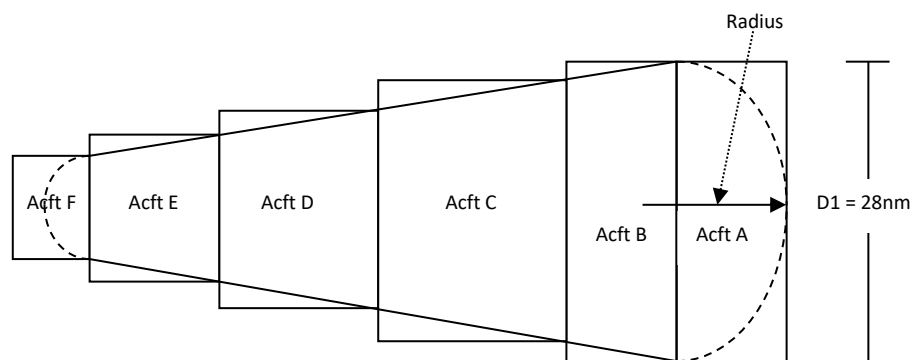

Figure 4-12 Allocation when Sufficient Search Time is Available

- 4.9.27 It is apparent from Figure 4-12 that this method of allocation results in small areas of individual search areas extending beyond the limits of the original search area. To reduce the incidence of unnecessary areas being searched, the length of D1 may be reduced to the diameter of the larger circle of probability. The length of the major axis of ensuing search areas will remain at this reduced length until the centre of the larger circle of probability has been included in a specific search area.
- 4.9.28 Little can be done to eliminate other portions of the rectangular areas that extend beyond the probability area, except perhaps, to split large areas into smaller sections, or use different allocation methods.

Over Sufficiency of Search Time

- 4.9.29 To employ time in excess of that required for first search coverage, several alternatives may be considered, e.g. first and second searches may be conducted simultaneously thus increasing the probability of detection or adjacent search areas may be overlapped. Other options include a reduction in track spacing and a reduction in sortie times to lengthen search crew rest periods.

Insufficient Search Time

- 4.9.30 A more normal situation is that insufficient time is available to complete the first search of the probability area in due time. When this occurs a compromise must be devised.
- 4.9.31 In reaching a compromise, the probability area may be reduced, the track spacing may be increased, the search height may be increased or a variation may be made to a number, or all, of these factors. The methods for variation of search area size and track spacing will now be considered.
- 4.9.32 By reducing search quality to the point of $C = 0.5$, that being taken as the minimum acceptable value, a suitable combination of area, track spacing and search height may be calculated to best

utilise limited resources. Application of the expanding search concept will ensure good coverage over ensuing sorties.

- 4.9.33 Worksheets 2,3 and 8 (Appendix D-7) has been constructed to assist in the determination of variable search parameters to achieve the best possible compromise:
- a) Section "A" is a statement of desired area and track spacing for a specified search height, associated coverage factor and POD;
 - b) Section "B" records the maximum area that can be searched if the practical track spacing (S) is used. The C and POD, in this case, will be identical to "A"; and
 - c) Section "C" records the widest track spacing required to search the whole of the area with the available aircraft hours, the resulting C and POD.
- 4.9.34 Having established the extremes of optimum track spacing and adjusted area (Section B), and optimum area and adjusted track spacing (Section C), it is appropriate to decide on the best possible option. This may be either one of these extremes or a compromise solution that requires amendment of each of area, track spacing and search height.
- 4.9.35 Section "D" may be used to examine the values of C and POD for various combinations of area and track spacing. It is good procedure, as a first step, to calculate the values necessary to achieve $C = 0.5$ and then look for a solution of compromise that results in a value of C between 1 and 0.5. The process may be repeated for different search heights before making a final decision.
- 4.9.36 With the area and track space determined, it is appropriate to calculate the area capable of search by individual aircraft then allocate them accordingly.

Allocation Variations to Suit Particular Aircraft

- 4.9.37 An improved search plan may result from the assignment of individual track spacing and search heights to particular aircraft. These adjustments may arise after consideration of the need for separation of search aircraft and each aircraft's search TAS, search height limitations and turn diameter. Variations specified, as a result of these considerations, should be gauged against the calculated practical track spacing to indicate resulting C and POD.
- 4.9.38 An overall POD may be obtained by calculating C for each individual search aircraft then determining a weighted average of these coverage factors to arrive at an overall figure for C and POD. These, although of little value to an SMC in their own right, may be included in a Situation Report or prove beneficial when determining the cumulative POD for a number of searches.

Allocation Chart Presentation

- 4.9.39 It is desirable that as much pertinent information as possible be depicted on a chart. All appropriate information may be plotted on one chart or it may be divided according to type and plotted on discreet charts. In either case, data may be plotted directly onto charts or on transparent overlays.
- 4.9.40 Individual aircraft search areas shall be identified by a "letter number", e.g. "A1".
- a) The letters used shall start at "A" and progress through the alphabet. If there are more than twenty-four aircraft on search, then double letters shall be used.
 - b) The number will indicate the day of the search, (not the sortie number or the search number).
- For example:
- i) The first aircraft tasked on day one of a search would be given "A1";
 - ii) The twenty-fifth would be given "AA1".
 - iii) The first aircraft tasked on day two would be given "A2";
 - iv) The twenty-sixth would be given "BB2".

Numbering will recommence with the first daylight search on each successive day.

Note: The letters 'I' and 'O' are not used to identify a search area because of the possibility of confusion with numbers.

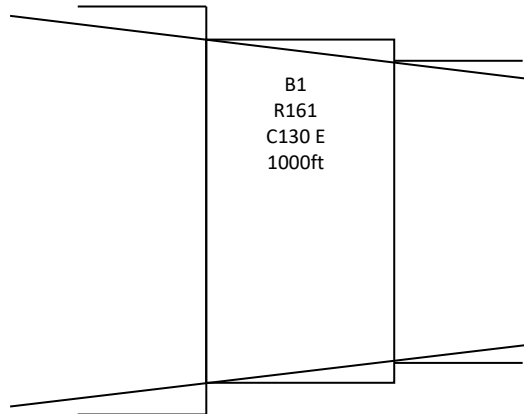

Figure 4-19 Information Displayed on Allocations Chart

4.9.41

4.10 SAR Crew Briefing

General

- 4.10.1 Comprehensive briefing and de-briefing of search crews is a vital component of search planning. They are time consuming processes, and in the case of briefing, preparation must commence at an early stage and, whenever possible, in good time before departure. It must be appreciated that many personnel engaged for search operations are neither trained for nor experienced in the search role. Field SAR personnel shall therefore be given every opportunity to familiarise themselves all relevant details of the distress. All instructions for the SAR operation shall be clearly and precisely presented.
- 4.10.2 The officer appointed to the briefing task, must be thoroughly familiar with the overall plan and individual search assets tasks.

Search Briefing

- 4.10.3 Comprehensive briefing of search assets is vital to every search operation. The SMC should be satisfied that the briefings are well prepared, and that where group briefings are to be conducted, the venue is suitable for the purpose.
- 4.10.4 Briefings for maritime assets will cover similar topics to those given to aviation and land assets, but there may be less opportunity for face to face briefing. Briefing Officers should be aware of the difficulties inherent in briefing indirectly and the increased potential for misunderstanding.
- 4.10.5 Similar arrangements shall be made for debriefing SAR assets.

Search Area Description

- 4.10.6 There are many ways of describing search patterns and the boundaries of search areas. In selecting the method to be used, RCC staff must consider the SAR knowledge of the recipients and the method to be used for the transmission of the information. Where possible two systems of description should be used simultaneously, such as a map/chart overly with coordinates for the search area boundaries. Two methods of explanation will minimise any confusion. This will become problematic for searches over water out of sight of land.

Geographical Coordinates

- 4.10.7 This is the generally accepted method of designating an area, the corners of a search area being defined by latitude and longitude. To avoid confusion, the positions should be listed in a clockwise sequence, ending with a repeat of the initial coordinates. The disadvantages of this system are the possibilities of error in measurement and transmission.

Universal Grid Reference

- 4.10.8 The Universal Grid is overprinted on all charts of the Joint Operations Graphic (JOG) (Military) series and is also shown on the majority of larger scale maps. These grid lines are also printed on all civilian topographic maps produced under the Universal Transverse Mercator (UTM) system.
- 4.10.9 The grid consists of numbered blue lines spaced 1000 metres apart at chart scale, both vertically and horizontally. Instructions for its use are printed in the margin of each sheet.
- 4.10.10 Another grid system may be encountered on earlier editions of the R502 series and the associated large-scale maps. This is based on a military 1000-yard grid and is overprinted in black. The method of use is similar in both cases. Some maps show both grids.
- 4.10.11 When using grid references, it is essential to identify the map used by name and edition number. (There are a number of maps that have the same name although they are of different scales, making the edition number a necessity)
- 4.10.12 It should be noted that the military might use a numerical system of sheet reference in combination with the grid reference. If this method is encountered, it will be necessary to seek interpretive guidance from a military source.

Track Line

- 4.10.13 A track line search may be designated by stating relevant points along the track together with the width of coverage, for example:
- "Fly a track 4 NM each side of a line between 16° 20' S 135° 15' E and 17° 50' S 137° 28' E."

Landmarks

- 4.10.14 Description of a search area by way of natural or man-made boundaries is particularly suitable when describing mountainous areas. Care must be taken to be precise. Vague descriptions such as "7 NM SSW of..." shall not be used. Proper direction in this case would be by way of positive bearing and distance, i.e. "bearing 202° (T) from Dixon Island at 7 NM".

Search Pattern Abbreviations

- 4.10.15 The international abbreviations are normally not used to brief domestic aircraft. Other RCCs may use the abbreviations when sending a briefing to an Australian SAR asset. If this briefing is to be forwarded to a SAR asset, JRCC Australia should ensure the pilot fully understands the type of search required.

Search Aircrew Briefing

- 4.10.16 A written record shall be kept of all briefings given to aircrew and other assets. Filing a copy of the Search Briefing Form most conveniently satisfies this requirement.
- 4.10.17 Search Briefing Forms shall be prepared for each aircraft task and dispatched or handed to the pilot in command or their delegate personally.
- 4.10.18 When the task for a search aircraft is amended, a hard copy amended briefing will be sent, where possible, to the aircraft crew otherwise it may be passed verbally, either directly or through a third party. Where a third party is used a hard copy of the amended briefing will be sent to that party. Confirmation will be obtained from the search crew that they have received and understood the amended briefing.

-
- 4.10.19 When pilots or their delegates are unable to personally attend for a briefing, the information may be dispatched by facsimile, email or telephone. The facsimile or email methods are preferred as the opportunity for errors of understanding is minimised and the transmission of maps, diagrams and other relevant hard-copy material can be achieved.
- 4.10.20 A pilot is, whenever possible, to be given a copy or reproduction of the relevant portion of the map in use by the RCC; it shall show the assigned search area and those areas adjacent to it.
- 4.10.21 Care must be taken in determining whether maps in use depict elevations in metres or feet. Pilots shall be left in no doubt in this regard.
- 4.10.22 In any case, where it is not possible to provide a pilot with a map or reproduction thereof, the briefing officer shall determine the maps and editions available to the pilot and ensure that the crew is totally aware of the areas, locations, and features that the RCC requires it to search. The briefing officer shall make every effort to eliminate any possibility of errors due to differences in data on the respective maps.
- 4.10.23 A briefing shall include the following factors:
- a) Full description and nature of the distress, and details that are already known not to be of any significance to the present search should be pointed out;
 - b) Present and forecast weather conditions to, from and in the search area and at destination and alternate aerodromes;
 - c) Search area and any description of clues that may indicate the presence of the target;
 - d) Instructions concerning the flight to and from the search area including route and levels;
 - e) Search task, including patterns to be flown and method to record areas searched;
 - f) Other aircraft in or near the area;
 - g) Communication procedures, frequencies to be used and controlling authority;
 - h) Frequencies to be monitored for transmissions from survivors;
 - i) Details of droppable supplies to be carried and any special dropping procedures;
 - j) Action to be taken on sighting the target;
 - k) Distress signals and visual codes;
 - l) Location and means of debriefing, including details of information which will be required;
 - m) Restricted airspace or airspace arrangements; and
 - n) Observer arrangement and the requirement to ensure they have a copy of the briefing. Where an observer leader is available, he should brief the observers.
- 4.10.24 A Flight Debrief Form should be supplied with the Aircraft Search Briefing Form.

Search Aircraft Operations

- 4.10.25 Pilots shall be briefed that before beginning a search, they should have established communications (air to ground, air to air and on board), have observers in position and be listening on any special frequencies. Pilots shall be instructed that after becoming airborne, if it appears necessary for search height or track spacing to be modified, the RCC should be advised accordingly.
- 4.10.26 Before beginning a search, the aircraft should be flown at search height for a time to familiarise observers with the apparent size and appearance of known objects on the surface. Observers may also develop an appreciation of distances at height, bearing in mind the planned limit of scan.

-
- 4.10.27 Aircraft that are engaged on a beacon search should start the search procedure at the highest practicable cruising level unless a small probability area has been defined when a search may start at a lower level.
 - 4.10.28 Pilots or navigators should log all areas, heights and appropriate times, and indicate on a map the areas covered by the search.
 - 4.10.29 When an object is sighted that requires investigation, the pilot should, if possible, mark the aircraft's position before deviating from track to ensure that it will be possible to resume track at the correct place. The use of GPS navigational equipment facilitates this.
 - 4.10.30 In marginal visibility and when the aircraft carries no markers, the crew can keep a target in sight by executing a turn with the target in the approximate centre. When the target is further away, the observer should keep the general area of the sighting in view and call out the position or distance as the pilot turns the aircraft towards the sighting.
 - 4.10.31 In sighting a missing target or survivors, the pilot should pinpoint the position, advise the RCC and survey the surrounding area with a view to assisting those who will be required to proceed to the scene later. When a target is sighted over water, the position should be recorded by GPS or if possible, be marked by some form of sea marker, smoke float, buoyant light or dye marker.
 - 4.10.32 It is desirable that continuous aerial surveillance be maintained over the location of the target or survivors.
 - 4.10.33 It is particularly important that continuous surveillance is maintained at sea, subject only to consideration of aircraft safety. Whenever possible, should a pilot be forced to leave the scene before the arrival of a relief aircraft, a buoyant radio beacon should be dropped, with the GPS position recorded.
 - 4.10.34 The need to dispatch additional aircraft to the scene should be considered as early as possible to avoid survivors being left unattended and to avoid the problem of relocation.

Communications Relay Aircraft

- 4.10.35 A dedicated communications aircraft should be used when communications are expected to be poor in the search area, for example:
 - a) HF is the only means of communication;
 - b) The search is of a large scale;
 - c) It is necessary to improve information feedback into the RCC;
 - d) It is necessary to improve information flow to search assets;
 - e) Search aircraft are operating without contact with the ground station;
 - f) It is the best method of maintaining communications with survivors or ground search parties and ground rescue assets.
- 4.10.36 A communications relay aircraft will normally be a suitably equipped SRA aircraft or military aircraft, have a minimum crew of pilot and radio operator, and have good on scene endurance.

Top Cover Aircraft

- 4.10.37 The provision of a top cover aircraft should be considered as a risk mitigation measure during operations that may expose SAR aircraft to undue increased risk.
- 4.10.38 The SMC is to discuss the requirement for a top cover aircraft with the pilot in command of the helicopter. The decision to task a top cover aircraft can be made by the SMC alone or on request by the helicopter pilot in command.

-
- 4.10.39 Circumstances that may require the provision of a top cover aircraft may include:
- a) Helicopters operating over water, although this will vary with the type of helicopter involved;
 - b) Helicopters operating at or near the limit of their endurance;
 - c) Helicopters operating in poor or marginal weather conditions; and
 - d) Helicopters operating at a rescue scene presenting special dangers, e.g. at night.

Note: If in doubt, consult the helicopter crews.

- 4.10.40 Aircraft tasked for top cover should be an SRA aircraft carrying supply drop equipment suitable for the environment. The primary tasks of the top cover aircraft will be to:
- a) Provide navigation assistance to the helicopter to locate the target;
 - b) Provide communications assistance to the helicopter; and
 - c) Provide immediate assistance by way of supply drop should the helicopter ditch.

Maritime Search Crews

- 4.10.41 When maritime assets are used for search operations, staff of other SAR authorities, i.e. police and military, may brief the search crews. The coordinating SAR authority shall require copies of briefing forms issued on its behalf to ensure that personnel are adequately briefed on all matters relevant to assets tasks. Maritime assets must be capable of carrying out the operation safely in the prevailing and forecast weather and sea conditions in the area.
- 4.10.42 All search preparations should be completed before the surface assets enter the search area including the establishment of communication with the agency coordinating the surface search and other assets (surface or air) participating in the search. Search crews should be briefed on:
- a) SAR frequencies and homing equipment monitored;
 - b) Observers positioned; and
 - c) Rescue gear made ready.
- 4.10.43 A surface asset carrying out a systematic search of an area with no visual reference points should maintain a dead reckoning (DR) plot of the last known position of the target, its own position, and the position of other ships and aircraft in the vicinity. The plot should also show date, time and possible drift of the target or survivors. Areas searched should be plotted on a chart. The use of a GPS or on-board electronic navigation system to provide the LKP or SP of the target and bearing continuously will provide the surface asset with situational awareness, bearing in mind it does not provide any subsequent movement due to drift or leeway.
- 4.10.44 To attract the attention of survivors, a surface asset should, if practicable, periodically make its presence known by making smoke during daylight and, at night, by rotating a searchlight beam around the horizon or, if clouds are low, by directing the searchlight vertically. When visibility is restricted, the engine should be stopped periodically to listen for shouts or whistles from the survivors.
- 4.10.45 Observers should be stationed as high as possible to increase the sighting range. Observers on board surface assets can also use the scanning techniques used by aircraft observers.

Land Assets in Aircraft Search

- 4.10.46 When land assets are used for search operations, the state or territory police or ADF SAR authority will conduct briefings. Search by land parties is normally only employed when aerial search is not possible or has been ineffective or when a closer examination of a certain area is desirable. It can be effective in forests, jungles and mountainous areas. Land assets may be used for both search and rescue.

4.10.47 JRCC Australia staff shall ensure that the coordinating authority is adequately briefed on the following:

- a) The current situation;
- b) A description of the missing aircraft, and a photograph if available;
- c) Details of the persons on board;
- d) A plan showing emergency break in points for the aircraft (if available);
- e) An instruction that unless accompanied by a Transport Safety Investigator, the aircraft wreckage is to be disturbed as little as possible;
- f) An instruction that unless on the direction of a coroner or a representative of ATSB the bodies of dead persons should not be moved except to the minimum extent necessary to extract survivors from the wreckage;
- g) The need to carry standard navigation and communication equipment and air to ground signal codes and materials;
- h) Details of communications arrangements;
- i) A warning that team members must not smoke, nor use naked flames near the wreckage;
- j) Information concerning any dangerous cargo known to be aboard an aircraft. In the case of a military aircraft, the need to exercise extreme care on account of ejector seats (being powered by explosives) and the potential incidence of ammunition, bombs, torpedoes, rockets, carbon fibre, noxious gases, poisonous substances etc.;
- k) Note: Contact with gases and substances associated with wrecked military aircraft can be lethal. Before approaching a military crash site, clearance shall be obtained from the responsible military authority; and
- l) an instruction that the wreckage must not be left unattended until taken into custody by a representative of ATSB, or placed under guard by the police.

Note: More complete information on the responsibilities of ground parties upon locating a crash site is contained in the booklet Civil and military aircraft accident Procedures for Police Officers and Emergency Services Personnel.

4.10.48 RCC staff shall ensure that land parties are aware that serious hazards to health and safety may exist at aircraft crash sites. Ground personnel have been injured and become ill and died as a result of crash damage, fire of composite materials, exposure to gases and poisonous substances. Certain radioactive substances may exist in military aircraft structures. Carbon fibres are electrically conductive and may short-circuit nearby electrical equipment. It is repeated that for the safety of ground party personnel, it is imperative that clearance be obtained from the responsible military authority before approaching a military crash site.

4.10.49 At the request of a land party operating in unfamiliar terrain, an aircraft may be provided to enable the asset leader to make an aerial reconnaissance of access routes in difficult terrain.

4.10.50 It may be necessary to position an aircraft over a crash site after the arrival of a land asset, to relay radio messages, or to interpret and relay ground signals.

4.11 SAR Crew Debriefing

Overview

4.11.1 Full and proper de-briefing of search assets is as important as the briefing process. Included in the briefing shall be instructions on the de-briefing procedure to be followed on completion of the search task. Where possible, blank debriefing forms will be given to the aircrew. A careful interrogation and evaluation of each search crew's effort is essential for intelligent forward planning.

-
- 4.11.2 Where a FCP or FFB is established, pilots, observer leaders, surface search asset leaders and others shall be instructed to attend after their sortie for de-briefing.
- 4.11.3 Reports are required on anything that the search teams themselves consider pertinent, and may include:
- a) Report on actual weather conditions;
 - b) Positions at which sighting investigations were made;
 - c) Descriptions of items which were investigated;
 - d) Accurate description of areas searched and not searched with an assessment of the effectiveness of the search;
 - e) Results of monitoring of radio frequencies;
 - f) Any operational difficulties encountered; and
 - g) Observer debrief forms when available and completed.

4.12 Land Search Operations

Overview

- 4.12.4 Police authorities undertake the responsibility for coordination of land search and rescue.
- 4.12.5 The previous chapter, Search Planning and Evaluation describes how to determine the area where available search efforts should be deployed. Once this area has been determined, a systematic search for the target should be planned. Prior to a search operation commencing, the search planner should provide a detailed search action plan to all involved, specifying when, where and how individual search assets are to conduct their operations. Coordination instructions, communications frequency assignments, reporting requirements, and any other details required for the safe, efficient and effective conduction of the search must also be included in the search action plan.
- 4.12.6 The selection by the SMC of available SAR assets to be used in SAR operations should take into account the following considerations:
- a) The need to reach the distress scene quickly; and
 - b) Suitability for at least one of the following operations:
 - i) Provision of assistance to prevent or lessen the severity of accidents;
 - ii) Conduct of a search, primarily by air but with the assistance of maritime or land assets as required;
 - iii) Carriage of supplies to the scene of an accident and, if necessary, delivery of supplies; or
 - iv) Execution of a rescue, (by maritime and land assets or by helicopters; and as required fixed wing aircraft to provide guidance to assets or to relay communications).
- 4.12.7 In coordinating a land search, the SMC, as guided by local procedures, will activate land, maritime or aviation assets depending upon the situation. JRCC can assist with advice on suitable aircraft for SAR operations.

4.13 Land Search Assets

Land Assets

- 4.13.1 Search by land facilities alone is usually impractical for large search areas but it can be conducted in most weather conditions and can provide complete coverage of a confined area that cannot be

thoroughly searched from the air. Land parties are also critical in operations where the search is carried out from the air and the rescue is needed by land facilities.

- 4.13.2 The need for coordination between land rescue assets and search aircraft should be considered, and plans should cater for the need of two-way radio communication. There may also be a need in remote areas to keep land asset supplied with fuel, water and food by means of airdrops.
- 4.13.3 When the survivors are located, the SMC should liaise with the police commander with a view to expediting the return of survivors to a place of safety. Consideration should be given to aircraft relay and the use of suitable motor transport: ambulances, four-wheel drive vehicles, buses, etc. The location of deceased persons will require adherence to local procedures in compliance with the respective Coroner's Acts.
- 4.13.4 Specialist police and military land parties are equipped with material useful to the SAR role. It is desirable that land SAR assets be equipped with basic navigation aids, two-way communication equipment, sufficient clothing, medical supplies and rations to reduce the need for air drops and specialist equipment appropriate to the asset's particular role.

State Emergency Services (SES)

- 4.13.5 The SES or equivalent in each State or Territory will provide trained and disciplined teams of volunteer search personnel. The training will vary depending on:
 - a) The location of the SES Asset,
 - b) Type of terrain likely to be encountered by members of that asset (i.e. Victorian SES would have a snow capability while western Queensland and Western Australian Asset would have a desert capability),
 - c) Number of staff available for training
 - d) Support provided by individual State and local governments, and
 - e) Necessity of the assets for SAR incidents.
- 4.13.6 With respect to SAR, SES members are trained in any/or all of the following depending on location:
 - a) Basic land search techniques,
 - b) Radio operation
 - c) Log taking
 - d) First aid
 - e) Crime or suspicious scene preservation
 - f) Vertical rescue
 - g) Logistics
 - h) Planning
 - i) Flood boat operations
- 4.13.7 Well trained search dog and handler are an effective search tool, provided that they are used correctly. To obtain the maximum value from search dog teams, it is essential to have an understanding of the search dog capabilities available and the conditions best suited for their deployment.
- 4.13.8 Lost Person Behaviour methodology recommends the use of dogs in all missing person categories. They are particularly valuable in searches for missing persons with dementia, autism, and who are despondent, as these subjects can often be passively or actively evasive of search teams.

Search Dog Capabilities

4.13.9 Search dogs can be trained in a range of different ways to respond to different conditions and circumstances. Understanding these differences, including the benefits and limitations, will assist in determining the most effective search dog capability to be utilised. Search dog capabilities are categorised into 6 main groups indicated in the table below:

SEARCH DOG CATEGORISATION		
TYPE	DESCRIPTION	USES
Air Scenting Area Search	Work off lead and use airborne scent. They are normally non-discriminate and will detect any human scent and other relevant scents to home in on their target.	<p>Considered to be the most efficient tool for search controllers</p> <p>Can efficiently search large areas</p> <p>Can search difficult, steep terrain more easily than humans</p> <p>Can easily integrate into a search area</p> <p>Not bounded by time constraints</p> <p>Can catalogue the smell of team members</p> <p>Can search buildings that have collapsed or otherwise damaged</p> <p>Will detect live and deceased people on land and underwater</p> <p>Best used in less populated areas such as bush land and rural areas including farmland, parkland, golf courses and car parks, shopping centres and sporting complexes after closing</p> <p>Able to locate people who are actively hiding, deceased bodies, deliberately concealed bodies and submerged bodies</p> <p>'Live find' trained</p>
Ground Disturbance Tracking	Working on lead, this category follows a target's footsteps by utilising ground scent.	<p>Most effective when a short period of time has passed (preferably 1-2 hours)</p> <p>Requires the search area to be uncontaminated where there has been no other recent foot traffic</p> <p>'Live find' trained</p>
Scent Specific Tracking	By working on a harness and long lead, this category is trained to detect human scent on the ground. After smelling a scent article/source from the missing person they will search around the last known position to determine the path the missing person walked in order to find them.	<p>Scent discriminating by following the scent trail of a specific individual</p> <p>Can be used to rapidly establish direction of travel where a scent source or article of the missing person is available</p> <p>Requires an uncontaminated scent article/source of the target</p> <p>Handlers prefer to obtain the scent article themselves</p> <p>People in the area are not to interfere with a scent specific tracking dog</p> <p>There is no time constraint. 24 hours on any surface is within their capability and 48 hours or more if the conditions are suitable</p> <p>'Live find' trained</p>
Cadaver/Human Remains Detection (HRD)	Work off lead and search for the presence of deceased persons or human remains that may be on the surface, buried, or hanging.	Used in missing persons response, cold cases, mass graves, disaster responses including fires, floods, earthquakes etc.

SEARCH DOG CATEGORISATION		
TYPE	DESCRIPTION	USES
Water Search	Predominantly Cadaver/HRD trained dogs that are trained to work along the shoreline or from a boat, to search for the presence of human remains in salt or fresh water.	Can work in rivers, lakes, dams, or the ocean Dogs are trained to alert and their handlers who then take a GPS reading to mark location Important that they work closely with Police dive teams on the scene to pinpoint location for divers 'Live find' trained
Avalanche	Search avalanche and heavy snow conditions for the presence of persons buried.	Rapid activation of teams is essential Pre-developed MOUs and activation protocols should be in place to optimise response 'Live find' trained
Urban Search and Rescue (USAR)	Search collapsed structures and debris piles from man-made or natural disasters for the presence of live victims.	Work off lead without a collar Used to working at distance from their handlers Particularly valuable in areas that are too difficult or dangerous to send humans 'Live find' trained

Explanatory terms

- 4.13.10 **'Live find' Dogs** - The term 'live find' dog is used for dogs that have been trained to find missing people that are still alive. However, most 'live find' dogs will also be able to find deceased people.
- 4.13.11 All search dogs have been trained as 'live find' dogs, with the exception of Cadaver/HRD Dogs which have been trained specifically to focus on deceased persons.
- 4.13.12 **'Scent picture'** - All matter gives off scent to some degree which enables Search dogs to utilise their superior sense of smell as their primary search tool. They are able to do this by following a 'scent picture' that is made up of a combination of minute particles that tend to fall to the ground at varying distances from the source.
- 4.13.13 Composite scents consist of natural and artificial scent. The scent picture will vary with each individual, depending on ethnicity, diet and habits. Other contributing scents may include body odour, hair oil, toothpaste, equipment, footwear and those scents released from brushing and breaking of vegetation and the crushing of small insects.

Using Search Dog capability for SAR

- 4.13.14 Determining which type of search dog capability to use for a search can depend on several factors, which need to be considered in the planning stages of a search operation. These factors include:
- a) time elapsed;
 - b) Environmental and weather conditions;
 - c) Proximity of search teams; and
 - d) Availability.

Additional considerations for Search Dogs

- 4.13.15 **Types of Dogs** - The different search dog capabilities mentioned in the table above can be utilised in tandem for a search and rescue operation. For instance, a Scent Specific Tracking Dog can be utilised to establish direction of travel, and Air Scent Dogs can search offside to the track.
- 4.13.16 Cadaver/HRD Dogs and 'live find' dogs can also be used in the same search.
- 4.13.17 Some handlers have their dogs trained for multiple capabilities. For instance, a dog may be trained as air scent and scent specific, cadaver and live find trained etc.
- 4.13.18 Scent Specific Tracking Dogs require an uncontaminated scent source or article. This can be collected from a scent article such as the missing person's clothing, pillowslip, hairbrush etc. The scent can also be obtained using a gauze pad to absorb scent from the seat of a car or steering wheel. The most important thing is to ensure the scent is collected properly and not contaminated by another person's scent. Most dog handlers like to collect the scent article themselves to ensure its purity. If this is not feasible, it is best to contact the dog handler and find out how they would like the scent article to be collected.
- 4.13.19 Environmental considerations - It is important to understand that dogs, like other animals, are subject to outside influences which have a direct bearing on their behaviour. Therefore, the performance of any dog, no matter how highly trained, is not always consistent and cannot be expected to work effectively under all conditions. This is often misinterpreted as a fault and instances have occurred where the use of dogs in SAR has been refused, simply due to a misunderstanding of the capabilities and limitations of search dogs as a search tool.
- 4.13.20 The following will affect the success of a search depending on the type of search dog used:
- Time - This is of prime importance. Search dogs should be deployed early as a fresh scent is easier for a dog to track. Dog teams can be activated and deployed quickly and independently of other search resources, and are a highly effective first response.

Ground Disturbance Tracking Dogs may be limited to shorter timeframes when a person has been reported missing due to their training of working footprint to footprint. They are most effective in areas that have been uncontaminated, because they are trained to scent on the most recent person that has walked in the area.
 - Vegetation - High undergrowth can restrict the distribution of scent making it more difficult for the dogs to detect.
 - Time of Day - Night and early morning is best as evaporation is less rapid. Environmental conditions can also impact a dog's ability to search an area. Search dogs can be utilised both during the day and at night, with scent conditions often more favourable early in the morning and in the afternoon and evening.
 - Start Point - Ground Disturbance Tracking Dogs do not need a piece of clothing belonging to the missing person to enable them to find and follow a scent, but if available, this should be preserved. Scent Specific Tracking Dogs require an uncontaminated scent article/source. Air Scent Area Search Dogs do not need a scent source.
 - Weather - A mild overcast day favours search dogs as it limits evaporation of scent. Most search dogs can be utilised in any weather, including wet and damp conditions where the scent 'drops' to the ground.
- 4.13.21 Missing person considerations include:
- Personal Hygiene - A person, because of circumstances or carelessness, who is unclean gives off a greater amount of body odour.
 - Food and Equipment - Strong smelling foodstuffs eaten by the missing person increases the scent picture, e.g. curry powder or spicy food as do deodorants, perfume etc.
 - Running - A person running gives off more scent than a person walking.

4.13.22 The following factors adversely limit the dog's effectiveness:

- a) Temperature – High (dry) temperature will quickly reduce the scent due to evaporation.
- b) Wind – A strong wind rapidly disperses the scent.

Dry and windy conditions are less optimal than cool and still conditions, however the dog handler will be able to advise the search coordinator as to how they will most effectively undertake the search, and what constraints they may have.

- c) Ground surface – Dry, bare ground adversely affects tracking dogs.
- d) Manure – Heavily manured land may disguise the scent.
- e) Water – Substantial running water courses can be an obstacle for tracking dogs.
- f) Scene contamination – People and vehicles in the search do not necessarily interfere with search dogs. Dogs can work on contaminated ground but it is best practise to keep foot searchers out of the area being searched by a search dog while it is working.

Search Dog teams in Australia

4.13.23 Search dog teams have been developed in most states across Australia and may be sourced (dependent on availability) from:

- a) Police
- b) State Emergency Services
- c) Private Search Dog Groups

4.13.24 Currently there is no Australian standard for search dog capabilities in place. Many search dog teams have been trained and assessed to UK, New Zealand, Swiss or other standards. Establishing strong working relationships between Police and Search Dog teams is fundamental to ensuring that mutual understanding, trust and confidence is built. These relationships are established through combined training and exercising between the different agencies and groups involved in SAR operations within that area.

4.13.25 Please note that bite trained police dogs that have been trained for more specific policing duties and not trained as a search dog, have limitations in searches particularly when required off lead. These types of dogs may in turn, be unsuitable when search teams are being used in the field or in public places.

Tasking Search Dog teams

4.13.26 It is important for the Police to have state arrangements and protocols in place with search dog teams to allow for rapid tasking to occur, this means the search dog team can begin responding while the human search teams are being mobilised. This is a distinct advantage, particularly in time critical response efforts.

Land Search using Maritime Assets

4.13.27 The water component of a land SAR incident might involve inland waterways, lakes, dams and coastal areas of the country.

4.13.28 While most of the land SAR maritime environment will be smooth water there are areas in Australia that have fast flowing white water, such as north Queensland and Tasmania; or have large bodies of dammed water. After adverse weather conditions, these larger areas of water can be affected by swell, waves and current beyond what would normally be encountered. The SES in most states have a flood boat capability which is also available as a SAR asset. Flood boats are of shallow draft and made of metal to resist floating debris. They are capable of getting close into the banks of creeks, rivers dams and other water areas to search sections not easily visible from the land side.

-
- 4.13.29 White water rapids require a different approach as they are not easily navigated by the larger flood boats. Searching from smaller man powered craft or from landward may be necessary.
 - 4.13.30 As with aircraft, the discretion to use the boat is in the hands of the skipper. Being of shallow draft and low freeboard they are not suitable for rough conditions or surf.
 - 4.13.31 Local Surf Lifesaving Assets may have a capability to assist in searches in or near the shoreline of beaches. In the more populated or tourist areas the Surf Life Saving Association will have water craft, suitable operators and a wealth of local knowledge.

Land Search Considerations for Aviation Assets

Considerations for Aviation Assets

- 4.13.32 As a general rule, slow aircraft or aircraft capable of reducing speed to 100 - 150 knots are most efficient for visual searches. Small and partially hidden targets are easily missed at higher speeds and faster aircraft may be subject to operational limitations making them unsuitable for low-level flights. Nevertheless, fast and/or highflying aircraft also play an important role in search operations, for instance when these aircraft carry out:
 - a) An electronic (radio) search to home on distress signals; and
 - b) An exploratory sweep of a large search area simultaneously with a search by a slower aircraft flying at lower levels, a method that is particularly effective in flat and unobstructed areas.
- 4.13.33 The suitability and efficiency of an aircraft for search, support and rescue operations will depend on which and how many of the following desirable features it possesses:
 - a) Operational characteristics:
 - i) Safe low-speed and low-level flight capability,
 - ii) Short take-off and landing (STOL) capability,
 - iii) Sufficient range to cover the area, with due regard to the location of redeployment bases,
 - iv) Manoeuvrability, especially for searches in mountainous areas, and
 - v) Payload capacity;
 - b) Equipment:
 - i) Suitable navigation and instrument flying aids,
 - ii) Radio equipment capable of receiving and homing on emergency radio signals, and
 - iii) Adequate communications equipment;
 - c) Availability of good observation posts;
 - d) Suitability for the delivery of supplies, emergency equipment and personnel; and
 - e) Facilities for the treatment and carriage of survivors.
- 4.13.34 The SMC shall select aircraft for use as SAR assets after consideration of the following factors:
 - a) Type of search necessary;
 - b) Type of terrain;
 - c) Type of navigation involved;
 - d) Need for dropping supplies;
 - e) Disposition of aircraft with respect to search area;
 - f) Crew experience and familiarity with the area;

-
- g) Weather conditions at and en route to search area; and
 - h) Rescue considerations.
- 4.13.35 Aircraft not equipped with radios should not be used on SAR operations except as a last resort.
- 4.13.36 Fast, high flying aircraft equipped with homing and/or direction-finding equipment that have the operational flexibility to descend to low level for final search are recommended for beacon monitoring.
- 4.13.37 Where terrain and vegetation is such that a contour search is necessary, preference should be given to:
- a) Helicopters,
 - b) High-performance short take-off and landing (STOL) aircraft, or
 - c) Light, manoeuvrable twin engine aircraft.
- 4.13.38 Where possible, single engine aircraft should be restricted to areas where the terrain would permit forced landings.
- 4.13.39 When possible, consideration should be given to engaging aircraft capable of carrying at least two Observers.
- 4.13.40 Where possible, landing sites should be as close to the search area as possible. The landing area selected should be clear of loose articles that may be blown into the air by the rotor downwash. On beaches, it is best to use the water's edge to form one side of the landing area. Communications should be established with the aircraft before its arrival and the pilot briefed on the landing site. If the pilot is unfamiliar with the location, a description of the area using large geographical features may need to be passed. If possible, a number of people should be deployed to secure the area before the aircraft arrives so that no one enters the landing area until the rotors of the aircraft have stopped or the pilot indicates that it is safe to do so. If the landing area is in a populated area, extreme care should be taken to ensure that no children run toward the aircraft once it has landed. When communicating with the aircraft it is important to inform the pilot of any obstacles in the immediate area. This is especially applicable to wire strung between trees and power lines as these types of obstacles are difficult to see from the air and present a danger to the safe operation of the aircraft.

Land Search and Rescue Assets (SRA)

- 4.13.41 Many types of aircraft will be suitable as SAR assets with little or no modification. However, care should be taken to ensure that even in an emergency, safety of flight is the primary consideration and should never be compromised. The normal operational and technical limitations of an aircraft as well as the qualifications of the crew, should be carefully noted by the SMC. SMC's must ensure they are cognisant of the factors relating to the aircraft and crew that may compromise the conduct of the SAR mission.
- 4.13.42 Some specialist SRA's that have undergone training from the JRCC are organised in Tiers and can be fixed wing aircraft or helicopters. The tiers relate to the capabilities and training of the aircraft and crews. When chartering aircraft for use as SAR Asset, the SMC shall, whenever practical and effective, select aircraft from trained SAR/Emergency operators including;
- a) Search and Rescue Assets (SRAs);
 - b) Police and State Emergency Service aircraft.
- 4.13.43 Advice on suitable aircraft can be obtained from JRCC

Land SAR Additional Aircraft

- 4.13.44 If additional aircraft are required, call out could be made according to the following priority bearing in mind suitability, location and availability:
- a) Domestic commercial aircraft,
 - b) Coast watch aircraft
 - c) ADF aircraft
 - d) Scheduled Regular Public Transport (RPT) aircraft.
 - e) Private aircraft

Land Search Private aircraft

- 4.13.45 Private aircraft may be used when so situated as to more readily effect the saving of life, operated by crew having particularly valuable local knowledge of the area to be searched, or when no other commercial aircraft are available.

Land Search Seaplanes

- 4.13.46 Seaplanes and amphibians are useful for search or for carrying supplies and personnel over water. Their use as rescue assets or carriers of personnel is limited to operations in lakes and river areas, or sheltered waters and bays. Under favourable weather and sea conditions, suitable seaplanes may also be used for rescue operations in protected waters, e.g. large lakes, bays, shore areas etc.

Land Search Helicopters

- 4.13.47 Helicopters are particularly useful SAR assets as their slow speed and ability to hover make them suitable for search as well as rescue operations, particularly where small targets are sought or close scrutiny of terrain is required. They also have the ability to land in a confined area and, in some instances, to operate from some vessels.
- 4.13.48 Some helicopters are fitted with winches or are equipped for flight in instrument meteorological conditions (IMC) and at night giving them an added advantage for search and rescue response. Turbulence, gusting winds and icing are conditions that the SMC should consider when determining helicopters as appropriate SAR assets.

Land Search Action Plan

- 4.13.49 At a minimum, developing a search action plan consists of the following steps:

Selecting search assets and equipment to be used.

Assessing search conditions

Selecting search patterns to cover the search area as closely as practicable

Dividing the search area into appropriate sub-areas for assignment to individual search teams;
and

Planning on-scene coordination

Note: While maritime search areas are calculated from well-established tables, land search areas will be a combination of theoretical, statistical, subjective and deductive reasoning.

- 4.13.50 Before committing resources to an intensive search, an evaluation should be made of the total search effort required and the contribution that may reasonably be expected from each search asset. When assessing available search capacity, care must be taken not to over-estimate either the time that a particular search team can spend in a search area or the capability of that team to remain effective over long periods of continuous searching.
- 4.13.51 Failure to make a sound estimation of these factors may result in one or more of the search assets being unable to complete its allocated task and the efficiency of the entire effort being seriously compromised.

Search Strategies for Land SAR

- 4.13.52 Although specific search plans will vary with the circumstances, a system has evolved which can apply to most situations. Land searching may be divided into three strategies:
- Fast / Reconnaissance
 - General Search
 - Contact Search
- 4.13.53 In land search, it is not necessary to go through the strategies in order. The SMC has to apply the most appropriate search strategy in order to maximize the POD.
- 4.13.54 Therefore, in the initial of a search the SMC may employ a Fast/Reconnaissance strategy may be employed. As time goes by and a person approaches their TFFS and/ or the search area expands for whatever reason, the SMC may employ a General Strategy in a high probability search segment, other teams for further Reconnaissance strategies in other segments. **It is a Strategy that is applied to the search, NOT a stage that the search goes through.**
- 4.13.55 Often a search will progress from one predominant strategy to another. However, depending on urgency, TFFS and resources, etc., varying strategies may be employed simultaneously in differing search segments.
- 4.13.56 With each of the three strategies there are associated search patterns that utilise the resources available to the best effect. Further details are provided in the search pattern section.
- 4.13.57 Approximately 70-80% of missing persons are located using the Fast/Reconnaissance strategies, therefore this strategy should be the first considerations of the SMC when planning for a SAR.

Immediate Response (Land SAR)

- 4.13.58 The initial search will normally consist of:
- A visual search along, and also parallel to, the track or intended route of the missing target. (A fast/Reconnaissance search)
 - Actions to determine whether a signal from an emergency beacon has been detected.
 - Formulation of a rescue plan
 - Coordination with other resources and agencies as appropriate.
- 4.13.59 The search may comprise:
- Developing a search area utilising a combination of theoretical, statistical, subjective and deductive reasoning
 - Developing sub-search areas
 - Allocating search teams
 - Searches utilising any one or a combination of the below search patterns.
 - Developing a rescue plan to return survivors to safety.
 - Gathering intelligence relevant to the search
- 4.13.60 The SMC should consider:
- Utilising the media if appropriate
 - Tasking local resources where the urgency of the situation dictates.
 - That a search and/or rescue may be required.
 - The terrain, vegetation, weather, intentions of missing persons, ability of the search teams, search light available and resources available.
 - That the coverage factor should generally not be less than 0.5; and
 - The use of electronic or thermal imagery equipment.

Reflex Search (Land SAR)

- 4.13.61 A reflex search (Bicycle Wheel Search) is one undertaken in the very beginning of a SAR when time is limited to develop a formal search plan. It is based on the premise that the missing person may be close to their LKP.
- 4.13.62 The SMC identifies the likely routes of the missing person based on information received, knowledge of the location, past events and the nature of the terrain. The first available search assets are initially tasked to search a limited distance along each identified route, checking for signs of the missing person and making visual and aural searches. This initial search should be timed to be completed by the time the SMC arrives on scene.
- 4.13.63 A reflex search will provide the SMC with situational awareness if the missing person is not located. Information on the terrain, weather, vegetation, likely routes, unlikely routes and hazards will be available for the SMC.

Fast/Reconnaissance Search (Land SAR)

- 4.13.64 This method is best used when the search team arrives at the scene not long after the target has been reported missing. There is an assumption that teams are looking for a responsive target. This search provides an immediate SAR effort and requires minimal search planning to commence.
- 4.13.65 **Land Search techniques:** Teams are briefed to check the LKP and tracks or route intended by the target. This is normally done by lightly burdened teams of faster searchers. Track running, with regular stops for aural searching, is the standard technique. Checks of perimeters or barriers, roads, track cutting, ridge running and obvious hazards or attractions can also be incorporated.
- 4.13.66 **Land Search considerations:** Teams used in this type should have some experience in clue and track detection and bush awareness. While there is a high percentage change that this type of search will locate a missing target it will also assist in defining the search area and providing information to the SMC of areas that need not be searched.
- 4.13.67 The main reason for the fast/reconnaissance is to carry out a quick search of the intended or calculated route, and also to obtain essential information about the search area, both of which will affect any future search planning. Fast/Reconnaissance teams may also find the missing person or object. A fast/reconnaissance search can be conducted using ground teams, vehicles or aircraft depending on the situation. A fast/reconnaissance strategy can be used, not only early in the search, but at any time to check on unconfirmed sightings or to recheck specific areas.
- 4.13.68 **Land Search Containment:** In any search, containment should be affected by cordoning the area where possible. This may through identifying physical barriers around the search area, regular patrols of roadways or tracks or the placing of physical barriers such as ropes, bon fires or vehicles across likely exit points from the search area.
- 4.13.69 **Composition of fast/reconnaissance teams:** Since they must travel light and fast, these teams should be kept small; ideally four persons. It is desirable that the leader or at least one member of the team have a good local knowledge of the task area and that all members are fit and capable.
- 4.13.70 **Task of fast/reconnaissance teams:** The area to be covered by these teams will concentrate on the area of highest probability. This area may be further limited by the existence of natural barriers such as large rivers, cliffs, etc.
- 4.13.71 Orders given to the fast/reconnaissance team may include the following:
- a) Check of all hazards which may have trapped or caused injury to the missing persons such as waterfalls, cliffs and caves.
 - b) Check tracks, huts, routes, sand-bars, waterways, waterholes, waterfalls and other likely areas for clues such as footprints, discarded items of clothing and equipment, food scrapes or wrappings.

-
- c) At regular intervals call out to a missing person and listen for a reply. When vehicles are employed, the vehicle should be stopped and the engine turned off.
 - d) Interview any person found in the search area and brief them on the situation. Record their names, addresses, car registrations and other details.
 - e) Notify the Field Search Headquarters of any clues found. Do not disturb the clues, mark off the area as well as recording the time found and the name of the finder.

4.13.72 **Fast/Reconnaissance Team Briefing:** The fast/reconnaissance team must be supplied with as much relevant information as possible about the missing person. Details of clothing, footwear, equipment or items carried, all of which if discarded by the missing person, could provide vital clues. Often the importance of clues is only realised long after they have been dismissed as irrelevant.

General Search (Land SAR)

4.13.73 When the SMC is able to define a search area, a decision may be made to cover the area with a general search. This is a general search of the area and may be used:

- a) Early in a search operation where there is a high degree of urgency; and
- b) To reduce the search area in those situations where the search area is large.

4.13.74 **Composition of teams for general search:** Teams should be kept small (8 to 10 persons) and as far as possible comprise persons of equal fitness and ability. Larger teams can be utilised depending on the terrain.

4.13.75 **General Search Method:** Having determined search areas, the method of searching a particular area must then be decided. The term 'general search' does not imply an examination of every square metre, but rather a check for signs or indications of the missing person. A General search involves searchers moving in a straight line through the area, evenly spaced and in sight of the adjacent searchers. Line searches (parallel or creeping) are the most common undertaken in the General Search strategy. A single line of searchers, evenly spread apart, searching to either side ensuring good coverage of the search area. The spacing between searchers is highly dependent on the vegetation and terrain, the thicker the vegetation the closer the searchers need to be to each other. The general rule of thumb is that searchers should be able to see the ankle of the person next to them, the Ankle Rule.

4.13.76 A check of campsites and other sheltered areas, such as hollow logs or caves, may produce results. A more detailed check of any natural hazards or areas where the missing person could be trapped or injured, should be made.

4.13.77 For areas of high probability, a modified form of general search may be employed using the same strength in the teams, but designating smaller task areas, resulting in a closer coverage of the areas involved. As for the reconnaissance search, the team should call out to a missing person at regular intervals and listen for a reply. This may need to be considered against the lost person behaviour.

Contact Search (Land SAR)

4.13.78 The contact search can be used to saturate an area of high probability, although it is usually the concluding stage of a search operation when searching for an unresponsive target or physical evidence of the target. Searchers are in contact with each other, very close together to prevent any area of ground not being searched.

Composition of Contact Search Teams

4.13.79 There is a practical limit on the size of a contact search team under the control of a single leader. This varies with conditions, but is normally 8 to 12 persons. The most experienced searchers should be at the ends and the centre of the search line.

Tasks of Contact Search Teams

4.13.80 The contact search team must search every possible refuge, since a missing person suffering in the bush is unlikely to remain in the open but will rather seek refuge in a sheltered place, out of the wind, wet or extreme heat. These will include ditches, hollow logs, amongst large rocks and under small ground scrub. All areas must be searched.

Contact Search Considerations

- 4.13.81 Searchers must look on both sides of obstacles and must continually look back as it is possible to completely by-pass an unconscious person lying behind an obstacle. A high degree of concentration is required in contact searchers, so the team leader should ensure that the searchers do not talk excessively or let their concentration lapse.
- 4.13.82 The contact search line must be kept straight. This is very difficult because different sections of the line will encounter varying obstacles, e.g. thick scrub. Some control must operate to ensure that faster searchers in clearer areas slow down and wait for those encountering difficulties. The best method is for the Team leader to be positioned in the centre of the search line, preferably to the rear and call instructions to the flanks. An area can be covered more effectively by a series of short sweeps, rather than a single long sweep. (This is both physically and psychologically beneficial to searchers).
- 4.13.83 Spacing of the line is maintained from whichever flank is following the boundary or otherwise defined track. The other flank indicates their progress by using markers. It can be an advantage to use different coloured markers on each day of the search. At the end of each sweep, the markers become a guide for the next sweep. Markers should be placed in such a manner that they can be seen easily when returning in the opposite direction. Consideration should be given to using biodegradable marker material, such as toilet or tissue paper so that it will disintegrate shortly after a search if it is not retrieved.
- 4.13.84 The contact search is continued sweep by sweep until the area is covered. This is exhausting, time consuming and requires large numbers of searchers. It is important that search teams, operating in the same area, maintain contact to ensure that mutual boundaries are properly searched.
- 4.13.85 In the instance that evidence is the search target a contact search with searchers on their hands and knees will be the norm. Crawling searchers will be able to use their hands or small tools to move all the ground cover aside. There will be no gaps between searchers, and the speed of progress will be that of the slowest searcher.

Calculated Search Area

- 4.13.86 This is a continuation of the immediate response, where the search area is expanded to cover the probability area calculated by reference to the target's location, target's intentions, estimated speed over the terrain, search area boundaries and hazards, and the target's medical, physical and mental condition, modified by ongoing intelligence gathering. This area may increase or decrease as further information comes to hand, which will incrementally increase the POD over the centre of the search area.
- 4.13.87 The SMC should consider:
- a) The availability of search aircraft
 - b) The availability of suitable ground assets
 - c) Logistical support for search teams
 - d) Location of Field Headquarters
 - e) Local weather conditions and expected forecasts.
 - f) Continual intelligence gathering

4.14 Land Search Area Coverage

- 4.14.1 Once the search area has been determined, systematic search for the target should be planned. Factors such as the weather conditions, time available for the search, search assets available, size and dress of target, etc., should be taken into account. These factors are related but some are more important than others. In planning a search operation, the SMC should endeavour to meet the requirements of the more important factors while satisfying the requirements of the others as far as practicable.
- 4.14.2 Search area coverage is the systematic search of a selected parcel of land to ensure the optimum probability of detecting the object being sought. The factors affecting detection capability have been reduced to four inter-related expressions. The terms and their symbols are:
- Area Swept (W)
 - Probability of Detection (POD)
 - Track Spacing (S)
 - Coverage Factor (C)

For land searches the Coverage factor (C) is a relationship between the mathematical area capable of being searched (ATNPS formula) and the area (A) given to each search asset to search. E.g. A team have been given 1km² to search with 10 searchers, 10m spacing, 2kph search speed and 4 hours to search. At the conclusion of the search they advise that they have completed the entire 1km² search area.

$$A = T \times N \times P \times S$$

$$A = 4\text{hrs} \times 10 \text{ searchers} \times 2\text{kph} \times 0.01\text{km} \text{ (10m as a kilometre)}$$

$$A = 0.8$$

$$C = A_s \div A$$

$$C = 0.8 \div 1$$

C = 0.8 (A Coverage factor of 0.8 in a land SAR gives a POD of 56%) This is not a reflection on the search team, what it means is that even though the team did search the entire area given to them, in the time taken with the resources and spacing it was mathematically only possible to search 0.8km², indicating that there were gaps and periods when the searchers were more than 10m apart.

Appendix E-6 contains details on the calculation to determine:

- Area: How much area can be searched?
- Time: How long will it take to search a given area?
- Number: How many searchers will be required to cover a given area?
- Pacing: How fast will the searchers need to walk to cover a given area in the time available?
- Spacing: What spacing will be needed between searchers?

Appendix E-7 contains additions to Naismith's Rule and will assist in determining target travel distances and times.

- 4.14.3 The number of searchers and search teams will be a factor in determining search area coverage. More time will be required to search a large area thoroughly when there are limited numbers of search assets unless the distance between searchers and search teams is increased. This is not desirable since it would reduce the probability of detecting the target. It may, therefore, be necessary to seek additional assets, either land or air, from other sources. It is usually preferable to cover a search area from the beginning with an adequate number of search assets.
- 4.14.4 When search assets are operating far from the Field Headquarters, consideration should be given to them being redeployed to an advance base so that more time will be available for the search and less time will be spent travelling to and from the search area.

Land SAR Target Type

4.14.5 The spacing (sweep width) will depend on the type, size, colour and shape of the target, its colour contrast with the surrounding medium and whether or not the target is moving and responsive, or immobile and unresponsive. Targets may vary from small children missing alone to a group of persons. It may also include a person in an inland waterway. All targets should be sought from a direction in which they receive the best illumination, colour brightness or contrast. This will normally be with the sun behind the searcher.

Land SAR Meteorological Visibility

- 4.14.6 If visibility conditions are poor, a reduction in spacing (sweep width) will be necessary, with the subsequent reduction in POD. Other weather conditions that may affect a search effort include:
- Fog, snow, and rain will make visual searching difficult and will require very close spacing between searchers.
 - Smog and haze may reduce the effectiveness of night signals;
 - Low clouds may reduce the amount of contrast between the target and the surrounding medium;
 - Precipitation reduces visibility; and
 - Terrain and vegetation in the search area.

Type of Terrain/Conditions

- 4.14.7 The type of terrain to be searched obviously affects the ease with which the search target will be detected. The more level the terrain the more effective will be the search. Not only can the searchers maintain a constant distance apart, there is less likelihood that undulations or irregularities on the terrain surface will hide the target. Thus flat deserts are easier to search than rolling hills, while rugged mountain areas are the most difficult. The more trees, vegetation, rock outcroppings and other surface irregularities that exist on land, the more difficult will be the search.
- 4.14.8 Open flat areas with little vegetation produce fewer shadows to confuse the searcher while dense forests have a multitude of shadows that can cause confusion to searchers. It is necessary for all searchers to be aware of the prevailing conditions and to modify their search techniques appropriately. The use of all six visual signals; silhouette, shine, movement, shape, spacing and shadow; when searching will provide the greatest chance of success.

Land Search Speed

- 4.14.9 The speed of all land searching will be dependent upon the slowest team member, but in some instances a slower speed will benefit target location, particularly in denser vegetation or in areas with a large amount of ground cover. A slower speed will enable team members to stop and search to their rear at regular intervals, thus looking behind ground objects.
- 4.14.10 The effectiveness of a search team depends on the number of searchers available, their experience, alertness, physical condition, incentive and the suitability of the search pattern. The speed at which they search also has a direct relationship to the effectiveness of the team's overall performance.
- 4.14.11 If feedback from the search teams indicates that searchers were excessively fatigued, it may be prudent to use a correction figure for fatigue and reduce the sweep width by 10 percent in any POD calculations. In the interests of Workplace Health and Safety if a team reported excessive fatigue the SMC should be considering removing them from the field and resting them.

Cloud Cover and Sun Light

- 4.14.12 The greater the amount of cloud cover, the less will be the ambient light in the search area. In a land situation this will reduce the amount of light with which to locate the target. In open areas with little vegetation the effects will be small, but in denser rain forests the effects may be to reduce the available search times dramatically.
- 4.14.13 Objects are seen at a greater distance when looking down-sun as opposed to up-sun particularly in early morning or late afternoon. With a clear sky and a bright sun, search conditions are at an optimum between mid-morning and mid-afternoon when the sun is high. Bright sunlight is especially detrimental when haze is present, due to the diffusion of light. Colour contrast is lost when looking up sun, with the result that small objects merge into a confused pattern of glaring light and shadow. Down-sun the glare is absent, haze is more transparent, and coloured objects show a marked contrast to their background.

Land SAR First and Last Search Light

- 4.14.14 The 45-minute periods after sunrise and before sunset are considered unsuitable for daylight visual searching on account of the sun's low elevation and resulting lengthy shadows.
- 4.14.15 These periods are therefore commonly discounted for visual searching at the planning stage, but may be used to move teams to and from their search areas, maximising the time available on scene. There may be other factors arising that impact upon search planning thus indicating the relative suitability of visual search during some or all of these periods.
- 4.14.16 Within proximity of the equator, where the apparent movement of the sun is at a greater angle to the earth's horizon and its rising and setting phases more rapid, these periods are less critical.
- 4.14.17 Examples of local factors that may need to be considered in the context of available search light are:
- a) A search within a tropical rain forest may best be started at dawn in consideration of a likely deterioration in local weather conditions later in the day.
 - b) A search of the western slopes of steep sided valleys may best be delayed until mid-morning.
 - c) A search of steep eastern slopes may best be abandoned earlier than 45 minutes before sunset.
 - d) The search of desert areas may be suspended during the middle of the day as the sun will bleach out the environment and create mirages which will limit the effectiveness of any search.
- 4.14.18 Time available to aircraft outside the periods suitable for visual search may be utilised in other ways, for example, beacon search, radar search or FLIR search.
- 4.14.19 Searches begun early in the day, or extending late in the day have a reduced chance of success in wooded terrain due to the shadows cast by the trees and the oblique angle of the sun. These areas are preferably searched when the sun is higher in the sky. Likewise because of the sun, mountainsides may be better searched in the early or late in the day depending on the direction the particular slope faces.
- 4.14.20 Unlike maritime SAR there are no tables developed for land SAR. The sweep width used in a land SAR will be entirely dependent upon the vegetation and terrain being searched. The search horizon is the distance from the searcher to where the chances of locating the target are zero. In open vegetation this distance can be considerable, while in a rain forest it may only be a few metres.

Land SAR Probability of Detection

- 4.14.21 Probability of Detection (POD) is a percentage value assigned to each search as an aid to the SMC. A low POD will necessitate re-searching, whereas a high POD may allow that area to be declared searched.
- 4.14.22 Appendix E-8 covers how to determine the POD of a search area. This is based on the marine POD calculations modified for land search. SMC's should be aiming for POD's of at least 80% for all areas searched.
- 4.14.23 While a maritime search concentrates on the surface of the water, basically two dimensional, a land search is very much four dimensional. There are the traditional three dimensions of the physical environment, which include the subsurface caverns and holes, the ground surface and all the associated concealment places and the super-surface, trees and canopy. The fourth dimension, time, also has an effect as targets will deteriorate over time. A missing person will physically slow down and take on some aspects of the environment such as sunburn, dirt and grim and discolouration. All of which contribute to difficulty in searching.

Visual Horizon: Ankle Rule (Land SAR)

- 4.14.24 In order to determine how far apart each searcher should be it is necessary to measure the search horizon for a particular vegetation type. This can be estimated from previous experience in this type of vegetation or can be determined through a more scientific method.

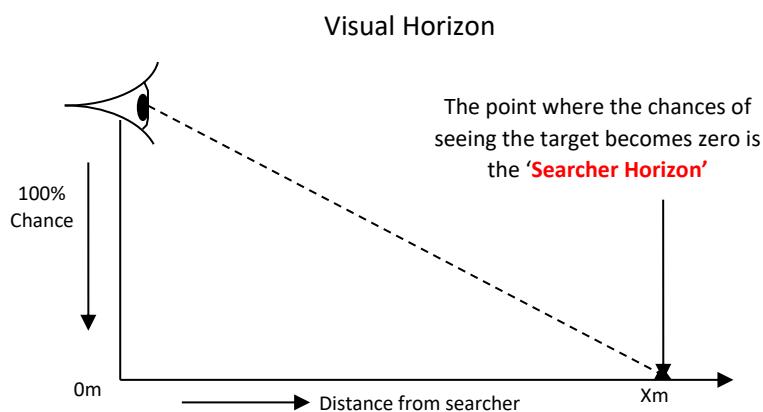

Figure 4-20 Search Horizon

- 4.14.25 Place an object of similar size and colour to the search target in the vegetation. Starting at the target searchers will walk into the vegetation until a point is reached when the target is not visible. Repeating this from several directions an average can be made of the distance measurements. This then becomes the search horizon for that particular vegetation. The searchers are then placed that distance from each other. This is the equivalent to sweep width in a marine world. The sweep width for an individual searcher will be the search horizon, spread evenly each side of the searcher.
- 4.14.26 Another term for the visual horizon is the Ankle Rule, where each searcher is separated by a distance such that the ankle of the next searcher in line is just visible. Therefore anything between the searchers should be visible to both.

Area Swept (Land SAR)

- 4.14.27 The Area Swept (A_w) is the total combined sweep width of all searchers in a team multiplied by the distance searched; the area searched by the entire team. E.g. If there are 10 searchers with a search horizon of 10 metres (0.01km) who have searched a distance of 2km then the total A_w for that team is 10 searchers \times 0.01km \times 2km = 0.2km². All measurements should be in kilometres for the calculations to work. This is covered in more depth in Appendix E-8.

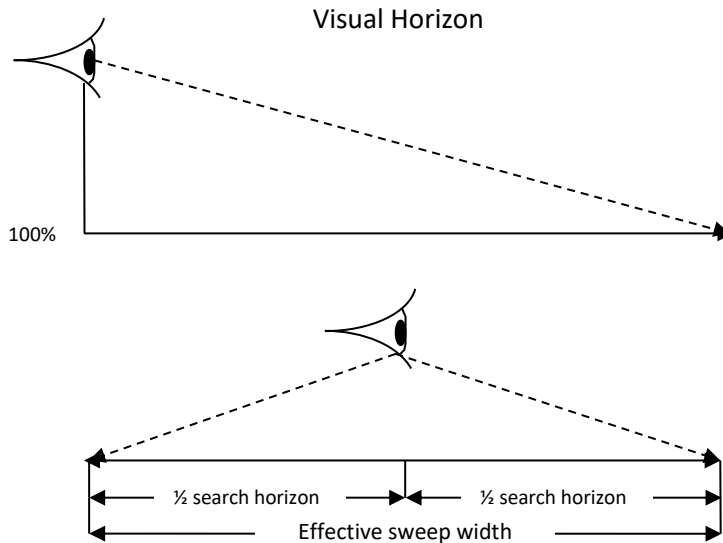

Figure 4-21 Effective Sweep Width

4.14.28 The zero detectability area of one searcher will meet that of the next searcher. The Bell Curve, figure 4-17, indicates that the probability of locating a target outside the sweep width is equal to the probability of missing a target within the sweep width if the visual horizon rule is utilised. Aside from these calculations, the standard rule of thumb is that searchers should be able to see the ankles of the searcher next to them. This ensures that theoretically, the area between searchers is searched twice, once by each searcher. In practice this is not often the case as both searchers may be looking in the same direction or looking away from each other.

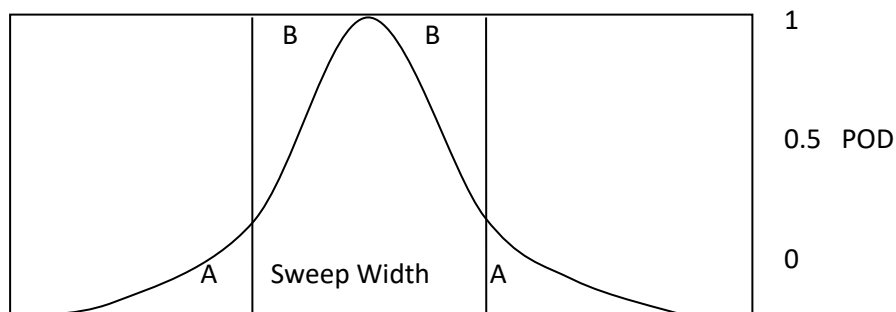

Figure 4-22 Search Bell Curve

Accuracy of Navigation by Land Search Teams

4.14.29 The navigational accuracy with which a search team is able to reach a search area and then execute the search pattern has an important bearing on the coverage of the area and the POD. Dead reckoning navigation alone generally produces poor results. Map reading can be effective with the assistance of visual markers such as mountains, rivers and man-made objects, but is very dependent on having good meteorological conditions. In areas where navigation aids are limited, search patterns should be selected so that greatest possible use is made of these aids. Regular checks need to be made by team leaders to ensure the search is still in the area assigned. The use of electronic navigation aids is becoming increasingly prevalent and while a valuable tool, the basics of old-fashioned map reading cannot be eliminated.

Land SAR Night Searching

4.14.30 Before deciding to search at night, there is a need to assess the urgency as well as the possibility of success against the risk to search team members. Night searching is not a task for inexperienced searchers. Some advantages and disadvantages are listed below:

a) Advantages of Night Searching

- i) Tracks and signs show up much better at night when illuminated by a torchlight. The torchlight forces the searcher to concentrate on the small field of view given by the light beam. The concentration assists with the detection of small clues.
- ii) Footprints and tracks are better preserved at night because they do not dry out as quickly and therefore maintain their shape and integrity.
- iii) In hot weather, night travel is much less strenuous than day-time travel.
- iv) Human voices carry further at night.
- v) Torchlight and fires can be seen by missing persons and can act as an attractant technique.

b) Disadvantages of Night Searching

- i) Possible risk to searchers through not being able to see obstacles.
- ii) The missing person may be injured whilst attempting to move to, or away from searchers that are heard in the dark.
- iii) The possible accidental destruction of vital clues outside the torchlight.
- iv) Missing vital clues
- v) Use of lights destroys searcher's night vision. On nights where there is a moon it is often beneficial to search without the use of torchlight. Given sufficient time for eyes to adjust it is surprising how much can be seen at night. Non-use of a torch also allows eyes to be drawn to areas of colour difference which would otherwise have been missed outside the torch beam. The use of a red covering over the torch can provide a reasonable combination of light to see by but sufficient darkness to notice small details in the bush.
- vi) Greater control problems for searchers.
- vii) The natural fear of the dark may cause greater apprehension in the missing person and searchers. Do not disregard the fear of the dark. The searchers at the end of a line search conducted at night can be greatly affected by this fear, to the extent that they gradually move towards the centre of the line. Their concentration is also very limited although their imagination often becomes heightened.

4.14.31 Vehicle boundary patrols are recommended at night and should utilise calling and listening techniques. A high point lookout or aircraft should also be considered.

Searching in Hazardous Areas

4.14.32 Many different types of man-made hazardous areas will be encountered by search teams in a wide variety of environments. Country or rural searching will necessitate searchers entering sheds, barns, machinery spaces during a search. Prior to entry the SMC should ascertain as much information as possible about the potential hazards to searchers. Information may include poisonous chemicals that should not be touched without gloves, potential breathing hazards that require face masks. Other dangers may include unprotected machines such as water pumps, grain augers, air compressors, all of which can cause severe injuries if clothing or limbs become trapped.

-
- 4.14.33 Grain silos, feed bins and other containers that store large amounts of produce can be particularly dangerous and should only be searched by those who have operational experience with them.
- 4.14.34 Within an urban environment building and construction sites present particular hazards to searchers. With the increasing occurrence of missing persons with dementia/Alzheimer's wandering from their homes it is often necessary to search these sites. Search team leaders should always approach the site foreman before entering onto a building or construction site. The foreman can then assign a person to guide the searchers around the site and provide advice about dangerous areas such as crane operating areas, concrete pouring sites, welding and cutting areas, compressor and electrical areas. On the larger construction site it may be necessary for searchers to undertake a quick orientation or induction to that work site. It may also be a requirement that all searchers wear hard hats whilst on the work site. While these sites need to be searched if they are within the search area unnecessary risks are not to be taken by searchers.
- 4.14.35 If the search is being conducted at night or over the weekend/public holiday it will be necessary for the SMC to locate a site foreman prior to any searchers entering those particular areas.

4.15 Land Search Patterns

- 4.15.1 The selection of a search pattern is very important and should only be made after all factors have been considered. The search pattern selected should meet the following criteria:
- Suitability:** It should permit the search to be completed within the time limits;
 - Feasibility:** It should be within the operational capability of the available search asset;
 - Acceptability:** The expected result should be worth the estimated time and effort.
 - Safety:** Any search undertaken should have the safety of searchers as a paramount concern. While SAR can be a risky and dangerous operation the risk - v - gain has to be assessed constantly.
- 4.15.2 Safety of the search assets: Land search teams will not normally sustain injuries or damage if they run into each other, but the SMC must be aware of the terrain and any known or potential hazards that may endanger the searchers. Where possible only those teams capable of negotiating the hazards should be used in those areas. E.g. only teams experienced in vertical rescue should attempt searching cliff lines. Other hazards may include wildlife, bush fires, storms, loose or rocky ground, hidden caves or mines. These hazards should form part of the team briefing prior to commencing a search.
- 4.15.3 If using vehicles, motor cycles, quad bikes or other motorised assets, specific attention needs to be paid to the disposition of assets within search areas. All vehicles should have their head lights on, regardless of the time of day. They should also carry, on their front bumpers, flags or pennants on flexible poles that exceed the height of the vehicles to warn other vehicle whilst negotiating crests. If flashing warning lights are fitted, they should also be activated. A team leader should be assigned to coordinate vehicle searching.
- 4.15.4 It is common to utilise aircraft, both fixed and rotary wing, in land searches. A single aircraft assigned to a single search area can easily be coordinated by the SMC. Multiple aircraft searching multiple areas can become a nightmare. Civil Aviation Regulations specify separation and height distances for aircraft. It is recommended that the aviation section of JRCC be contacted to assist in the coordination of air searches involving multiple aerial assets. This will relieve the SMC of the necessity of developing search areas, asset spacing, heights and briefings. JRCC will seek what areas need to be searched and all other relevant information and then develop suitable plans, including the issue of appropriate NOTAM's. These plans will be forwarded to the SMC for approval prior to being implemented. EMD will brief each individual aircraft and collate the subsequent results. Overall coordination of the land search will remain with the SMC.

-
- 4.15.5 The choice of search pattern is the prerogative of the SMC, who may elect to use only one pattern or several patterns simultaneously but in different areas. A series of search patterns may be used in sequence for the same area, e.g. single file, track sweep. The following factors will influence the SMC's selection of search pattern:
- a) The accuracy of the LKP;
 - b) The size and shape of the search area;
 - c) The number and type of SRUs available;
 - d) On-scene weather;
 - e) The distance to the search area;
 - f) The availability of navigation aids in the search area;
 - g) The size and detectability of the search object;
 - h) The desired probability of detection;
 - i) The limitations of time; and
 - j) The terrain of the area where the search will be conducted.
- 4.15.6 In order to achieve the greatest efficiency from search teams, it is necessary that each team be deployed to ensure the maximum terrain is covered in a sweep and all members are actively employed. This particularly applies where team members are tired and may tend to follow the leader without attempting to search.
- 4.15.7 The SMC will determine the search pattern that is required to search a particular area. This will take into account the terrain to be searched, the target, number of searchers and capabilities of the search teams.
- 4.15.8 The Team Leaders will be responsible for implementing the search pattern of the SMC. The Team Leader will also be able to modify the SMC search pattern if the situation on-scene changes or a more efficient pattern is available. The Team Leader will communicate these changes to the SMC.
- 4.15.9 The Team Leader will place individual members within the search pattern and allocate primary areas to be searched by each member. While on the move, the Leader must ensure members maintain their position within the pattern and remain alert.
- 4.15.10 Global Positioning Systems (GPS): The use of GPS for navigation has been increasing over the last decade as they have been reduced in both size and cost. GPS are to be considered as another tool in the SMC's arsenal. While each search team should be able to navigate via a map and compass the issuing of a GPS to each team will provide a backup method of determining their exact location. When training, emphasis needs to be placed on gaining navigations skills using the older methods and not relying on GPS or other systems. The reasons for this are the bugbear for most modern technology, flat batteries. A GPS with a flat battery is no more than a paper weight. The GPS should be used as a method of confirmation rather than the primary navigation tool. Where they do come into their own is providing an exact recording of the search areas undertaken by that particular team. The search details can be down loaded onto a computer and overlaid on a map. This will indicate precisely to the SMC what areas were searched and what areas remain. This removes any doubt that a team leader may have in relation to their search. A GPS will assist when searching in featureless terrain or when natural boundaries are not available to define a search area. Spare batteries need to be carried by the search team. Although all GPS's provide similar basic information there is such a variety of operating procedures that training needs to be model or brand specific. Where possible GPS's of the same type should be carried by search teams in the same search, allowing for technical information to be passed from FHQ to teams easily.

Common Land Search Patterns

4.15.11 Common search patterns which may be used to suit varying terrain and circumstances include the following:

- a) Single File
- b) Track Sweep
- c) Point and Flank
- d) Purposeful Meandering
- e) Parallel Sweep
- f) Creeping Line Ahead
- g) Square Search
- h) Contour Search
- i) Vehicles in Echelon

Single File Search

4.15.12 This pattern may be adopted when searching a foot track or narrow defile.

4.15.13 The team travels along the track, one behind the other, searching the track and its immediate surrounds, paying particular attention to the member's primary arc of search. Position 1 will search ahead on the track and to approximately 45° to both sides. Positions 2 and 3 will be searching each side of the track from 45° ahead to 45° behind. Position 4 or the rear member will be searching the track, but stopping every ten metres to check behind all obstacles. The Team Leader is not assigned a search sector but will check all areas as required.

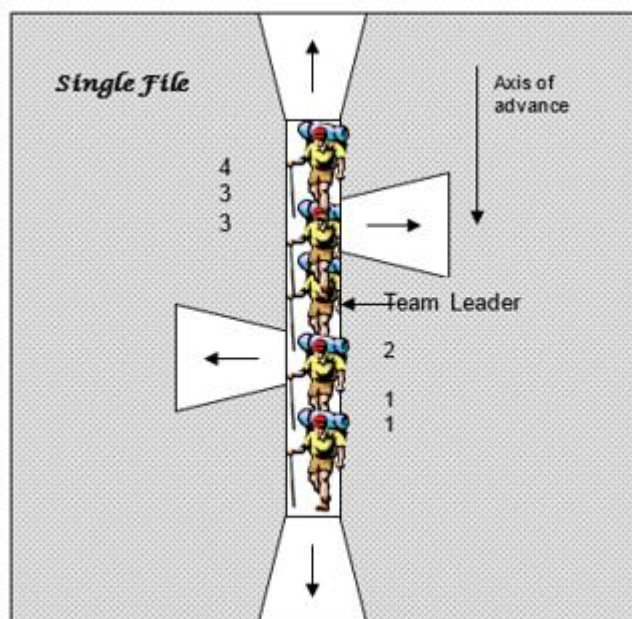

Figure 4-23 Single File Search Pattern

4.15.14 The Leader is positioned where best control of the team can be affected, usually towards the middle of the team.

4.15.15 This search pattern can be used when searching for a person who is expected to be mobile.

Track Sweep

- 4.15.16 Where terrain and vegetation permit, a more efficient pattern for searching a track may be a track sweep.
- 4.15.17 In this pattern, the Leader is positioned on the track, with the team forming a line extending either side of the track. This allows for searching an area out to the full span of the team.
- 4.15.18 The distance between team members will be greatly dependent on the thickness and type of terrain being searched. Refer to earlier sections for more details on separation distances.

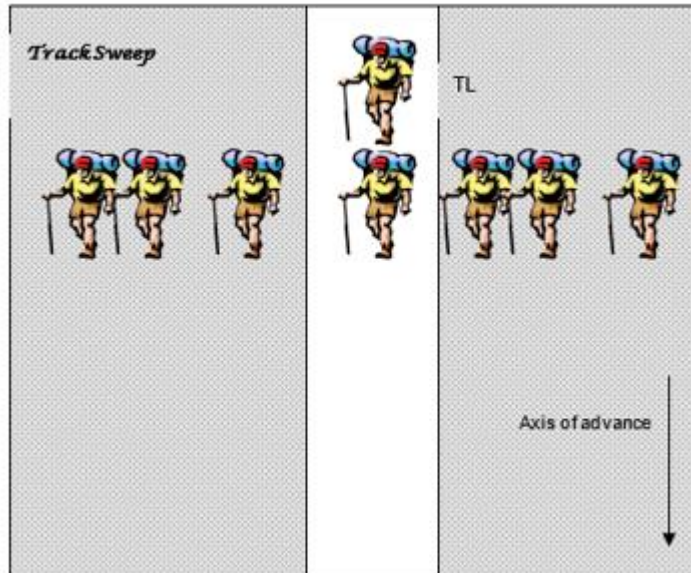

Figure 4-24 Track Sweep Pattern

- 4.15.19 This pattern can be used when the missing person is predicted to be mobile, but could also include persons who may sprain an ankle or fall injuring themselves. Missing persons have been known to sit or find shelter just off the edge of the track. Possessions, food wrappers and items of clothing may be discarded and tossed aside, landing a short distance from the track's edge.

Point and Flank

- 4.15.20 A common approach to following a track is with a three person team. The three-person team, comprised of a point person and two flankers, has several advantages. This is a method commonly used by armies throughout the world to locate targets, enemy or otherwise.
- 4.15.21 This pattern allows for consultation in difficult situations because three heads are better than one. If a searcher can convince another searcher that they are seeing a sign, then the chances are that it is a sign that is being observed.

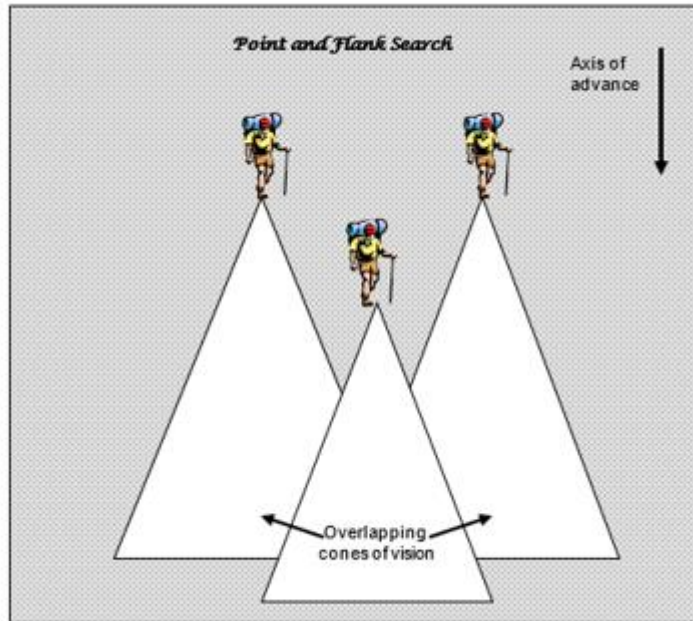

Figure 4-253 Point and Flank Search

- 4.15.22 When training, this method builds confidence, reduces errors, and benefits searchers by allowing a verbal exchange of the details of what is being observed rather than just mutually looking at a clue or disturbance.
- 4.15.23 It allows for the rotation of the point person, who may be physically on their hands and knees on the ground searching for a sign. Point is a tiring position, especially when signs are limited.
- 4.15.24 The team can split up at track junctions, with team members going down each track for a short distance. Any team member can call the team back together when they find a sign indicating the correct track.
- 4.15.25 This search pattern is not suitable in all terrain or conditions. Three member teams may not always fit in with the current team structures in some organisations.

Barrier

- 4.15.26 This type of search is set up between two search boundaries and is aimed at locating the missing person as they travel through a search area.
- 4.15.27 The boundaries need to be of sufficient definition to funnel the missing person through, such as rivers or cliff lines.
- 4.15.28 The search team travels back and forth between the boundaries, keeping a lookout for the missing person. The search is also valuable in state forestry areas and new growth forests used for logging. The grid nature of these areas allows searchers to be stationed at diagonal corners, providing vision on two sides while other searching is undertaken within the forests.
- 4.15.29 This can be done with a small number of searchers or by vehicle if need be.

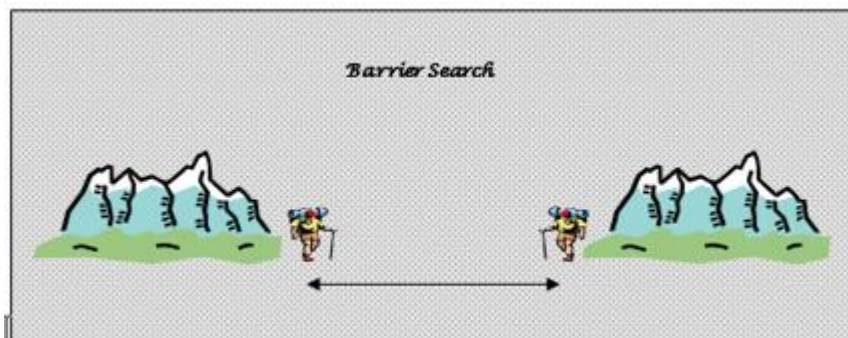

Figure 4-26 Barrier Search

Purposeful Meandering

- 4.15.30 This type of search can be used in most circumstances when the search area is defined. Statistically, this search pattern provides the best chance of detecting a responsive or unresponsive target.
- 4.15.31 The team is arranged in a line facing the direction of travel.
- 4.15.32 Several members of the team have compasses and act as guides to the remainder of the team.
- 4.15.33 The Team leader remains at the rear to provide overall supervision.
- 4.15.34 Each team member is free to wander or meander through the search area, to check out objects or sightings that catch their attention. Some objects may be better seen from the side and so escape the attention of a searcher coming from the front.
- 4.15.35 Each searcher has a definite visual horizon, and as can be seen in the diagram there will be areas searched or scanned several times by different searchers and also that there will be areas that are not searched at all. Those areas not searched are done so because there is nothing that has caught the eyes of the searchers (Shape, shine silhouette, movement, spacing and lines).

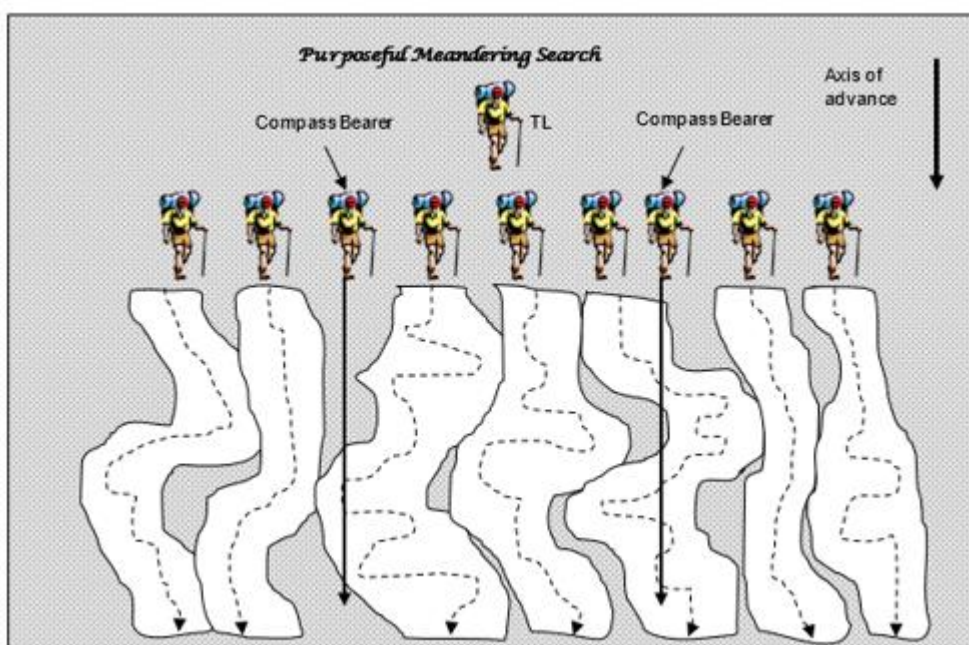

Figure 4-27 Purposeful Meandering Search

Square Search

- 4.15.36 When searching on a restricted front such as a gorge, the square pattern may be adopted. This will gain the maximum advantage from a team which cannot be extended to a full span.

- 4.15.37 This pattern can also be adopted while conducting a Track Sweep Search when the terrain closes in on the ends of the search team. Rather than bunching up the team members they can be formed into this pattern.
- 4.15.38 In this pattern, the Leader is positioned to best advantage, usually in the middle of the team. The members are placed in pairs to the front and the rear sides of the Leader's position.
- 4.15.39 The two forward groups will search ahead and to 45° each side. The two rear groups will search from 45° each side to 45° to the rear.

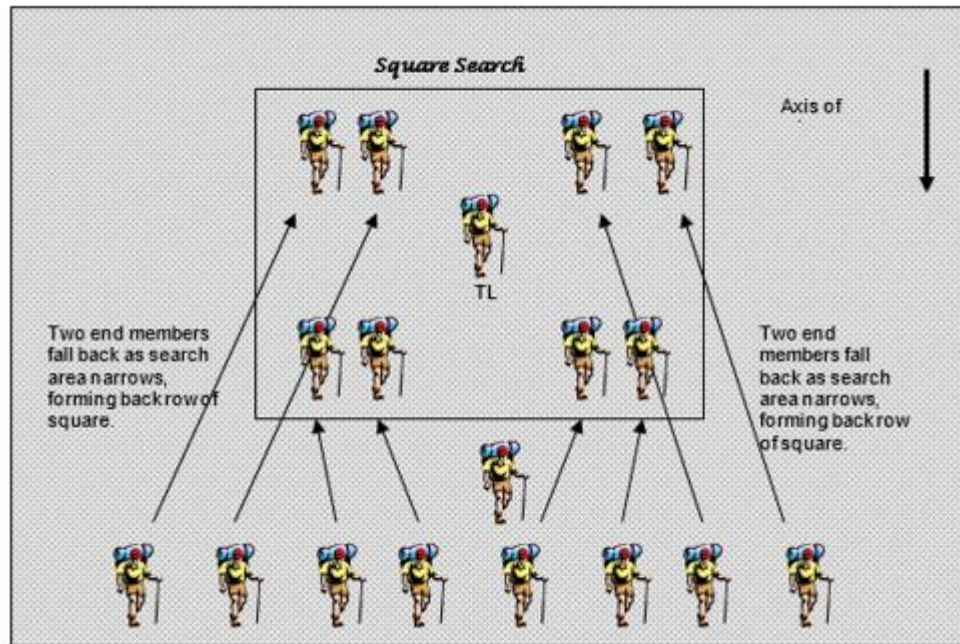

Figure 4-28 Square Search

Parallel Sweep (Single Team)

- 4.15.40 Parallel sweep pattern searches are used when the terrain and vegetation allow adequate control. This formation is normally used in both general and contact searches when thorough coverage of the ground is required.
- 4.15.41 It is used when the area to be covered can be done in sweeps. Some search areas may require several sweeps of a search team due to size or density of the vegetation. If a single team is conducting this search the outside searcher will be marking objects at 10m intervals to identify the area that has already been searched and will allow for alignment on the following search. Marking is now done with biodegradable tape on trees or other objects at eye height. At the conclusion of each sweep the team will move one team width to the side and resume the search in the opposite direction.
- 4.15.42 The simplest method of conducting a search is generally by the parallel sweep where a team will move through the search area paralleling a feature, such as a fence or road, or moving on a determined compass bearing.
- 4.15.43 In this pattern, the members are positioned parallel to a start line with the Leader located at the rear middle of the team. Under the direction of the Leader, the team sweeps forward from the start line until the area has been completely searched.
- 4.15.44 Refer to earlier section for more details on determining the distance of separation between searchers.
- 4.15.45 The speed of this search is governed by that of the slowest searcher. The Leader must ensure that all members proceed at the same pace, as this will ensure that there are no gaps left in the line and all areas are covered.

- 4.15.46 This search should only be used in areas where the terrain is of the same type, therefore allowing all team members to search at a similar pace.

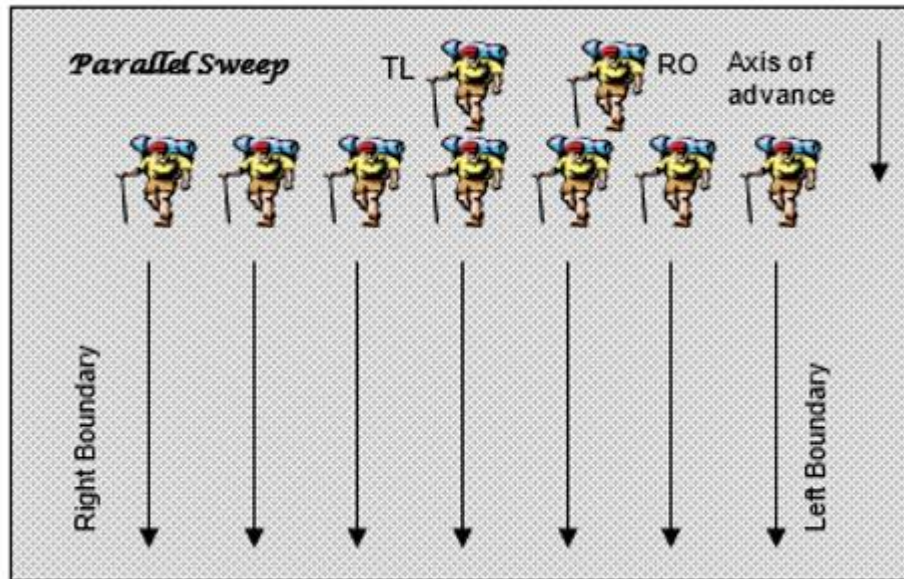

Figure 4-29 Parallel Sweep

Parallel Sweep (Multiple Teams)

- 4.15.47 Where a large area is to be searched, it is possible to use multiple teams in an extended line.
- 4.15.48 When using multiple teams, it is better to stagger the teams rather than combine all personnel into one large line.
- 4.15.49 The terrain and vegetation for all search teams across the line should be of similar type, allowing for all searchers to proceed at a similar pace. If there are great disparities in terrain or vegetation type or thickness, consideration should be given to dividing the area into smaller areas of the same type.
- 4.15.50 In the example shown below the left-hand team with the boundary on the left begins the sweep. The left hand member keeps the boundary while the right-hand member marks the right-hand edge of the line. After a suitable period of time, the second Team begins the advance, with the left-hand member finding the marked boundary left by the previous team. The right-hand member of the second team marks the right-hand edge of the second team's line. After a suitable period, the third team begins the advance, and so on. The search boundaries should be marked out with a biodegradable material such as toilet paper, used at regular intervals but close enough to be able to be easily seen by all searchers. The paper can be dyed for use on different days.

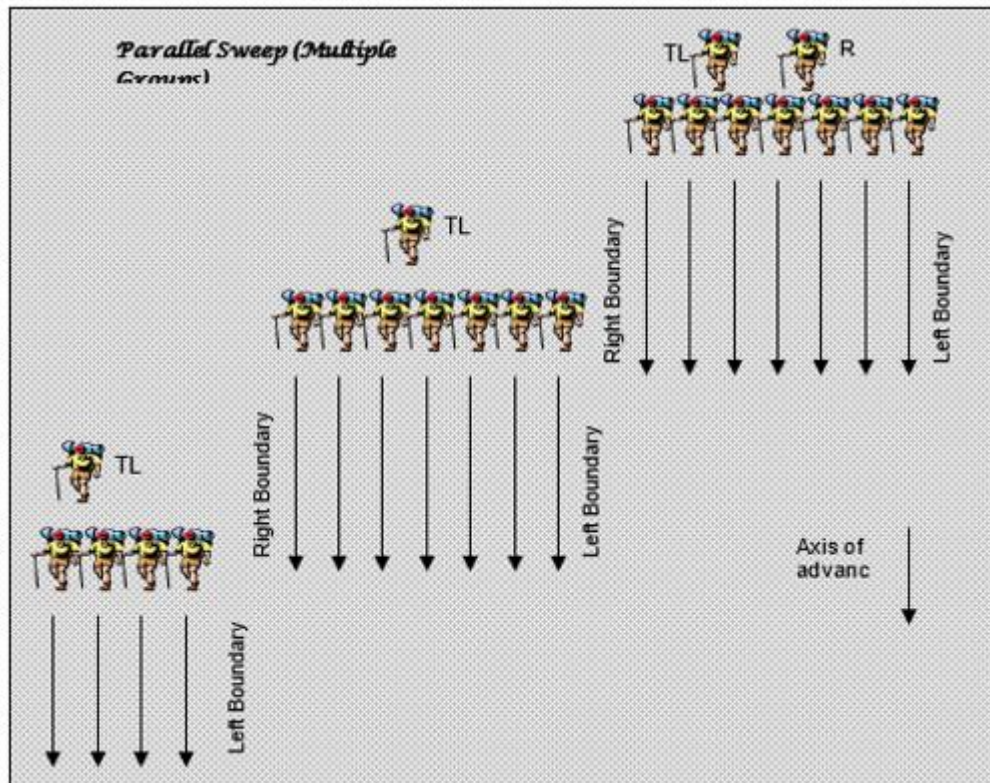

Figure 4-30 Parallel Sweep (Multiple Teams)

- 4.15.51 If a team catches up to the team in front in the staggered formation, it will be necessary for that team to pause to enable the front team to advance further ahead. Do not allow the teams to combine into a single line as control is too difficult.
- 4.15.52 The search line leader controls the movement of the teams through individual Team Leaders.
- 4.15.53 To assist in control, the search line leader will generally need to have available a radio operator to transmit instructions directly to the Team Leaders.
- 4.15.54 The search line leader's radio should be on a separate frequency to the search control net.

Creeping Line Ahead

- 4.15.55 Where team strength does not permit the searching of an area in a single sweep, the area may be searched in a series of sweeps known as the creeping line ahead search formation.
- 4.15.56 This method is particularly applicable in thick vegetation or rough terrain where control problems may preclude the use or employment of large teams. It is also a good search where there is a possibility the target has sustained an injury (perhaps as a result of a traffic crash/aircraft incident) and has wandered off a track or road a short distance and has collapsed.
- 4.15.57 To conduct this search, a start line and search boundaries are determined.
- 4.15.58 The team is placed in a parallel line along one of the boundaries, perpendicular to the line of advance.
- 4.15.59 The leader is positioned toward the middle and behind the team.
- 4.15.60 The team members on the flanks are tasked with marking the limits of their search. The search boundaries should be marked out with a biodegradable material such as toilet paper, used at regular intervals but close enough to be able to be easily seen by all searchers. The paper can be dyed for use on different days.

- 4.15.61 The team member acting as the marker will not be able to concentrate entirely on searching because of the distraction of tying the material to the tree. This needs to be allowed for in relation to the area covered and to the speed of advance.
- 4.15.62 Before beginning, a number of strips of toilet paper can be prepared, assisting the marker in carrying out the task.
- 4.15.63 The team searches the area from boundary to boundary in a series of sweeps, moving back and forth from the start line until the area has been searched.
- 4.15.64 When redeploying for a return sweep, it is essential that the team leader maintains control and ensures that the changeover is conducted as smoothly as possible.
- 4.15.65 To ensure a smooth change, there are two suggested methods:
- a) Method One:
 - i) The team on reaching the boundary halts and the member at the axis of advance (end of the line) marks the limit of search.
 - ii) The team then turns in the direction required and moves one team span past the marked limit thus maintaining their original position within the search line.
 - iii) The team then sweeps towards the opposite boundary.

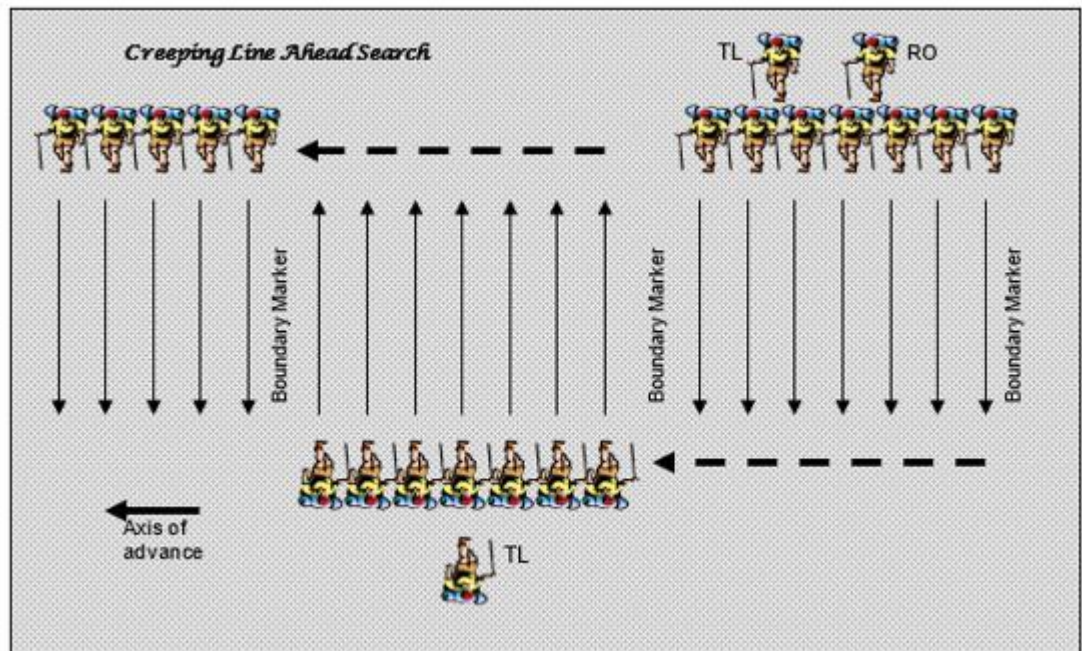

Figure 4-31 Creeping Line Ahead Search

- b) Method Two:
 - i) On reaching the boundary marking the limit of search and turning in the direction of the axis of advance.
 - ii) The member at the axis maintains position, the remainder of the team by-passes and forms up after one team span.
 - iii) The team then sweeps towards the opposite boundary.

Contour Search by foot

- 4.15.66 It is rare that an entire hill or mountain will be searched in one go. It is more often that segments of slopes will need to be searched.

- 4.15.67 When searching hills, ridges or spurs, it is advisable to commence searching from the high ground. This allows searchers to observe the ground from height, rather than attempting to look up a slope. There is often a road or track on a spur from which to commence a search.
- 4.15.68 Segment a hill, spur or slope into sections and search between the sections using boundary markers.
- 4.15.69 Safety is paramount as walking across slope is always riskier than walking down slope or up slope.
- 4.15.70 When searching the face of a slope consider using either a creeping line ahead approach or a staggered line approach to minimize rocks and debris being moved down the slope to other searchers.
- 4.15.71 In any search of hilly or steep ground, control must be maintained and the speed of advance adjusted to suit the terrain and the capacity of the searchers. If this is not done, injuries, particularly to ankles and knees, may occur.

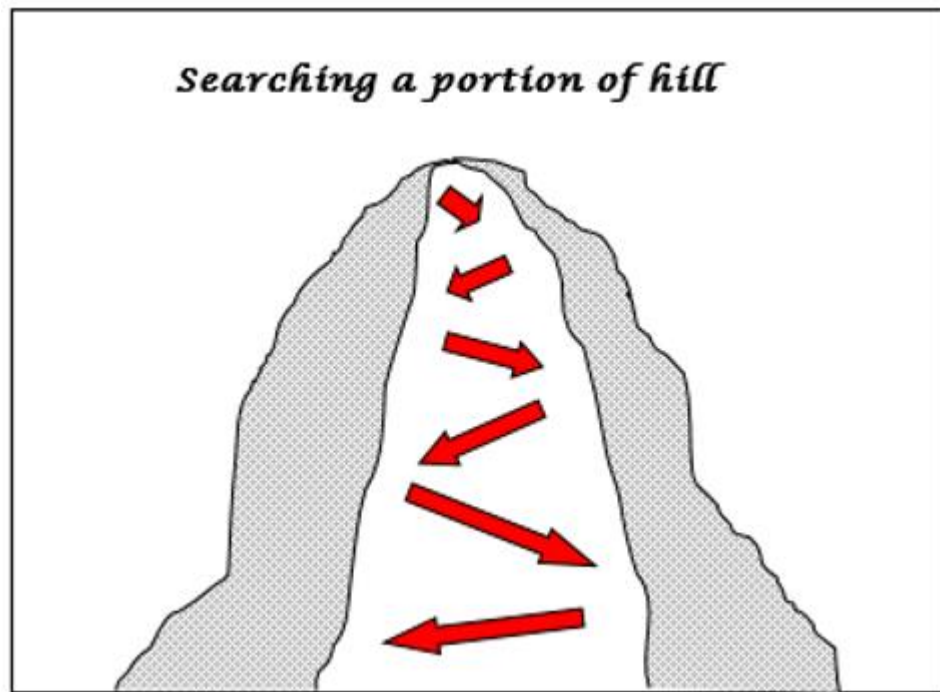

Figure 4-32 Search a portion of a hill

Expanding Square

- 4.15.72 The purpose of this technique is to closely search an area of high probability. It is particularly useful for thorough coverage of small areas. This technique is suitable for a maximum of 10 searchers.
- 4.15.73 A person is required to mark the outer boundary and ensure that the correct boundary is being followed.
- 4.15.74 Another person is required to locate the inner boundary. This ensures an even movement of the search line from the inside edge.
- 4.15.75 It is essential that the Team Leader directs the search from a central position behind the line.

- 4.15.76 Method: Mark out a grid square of approximately 50 metres centred around the area where close searching is required by using compass bearings and toilet paper or similar. Next:
- Search the inside of the grid with a contact search;
 - Set up a line from one of the outside corners of the grid and move around the grid in one direction;
 - Continue searching in this manner, spiralling out and around the grid square (it will gradually become circular);
 - The line will become unmanageable with more than 10 searchers; and
 - In very thick bush, an expanding square search will take about 3 hours to search an area 300 x 300 metres.

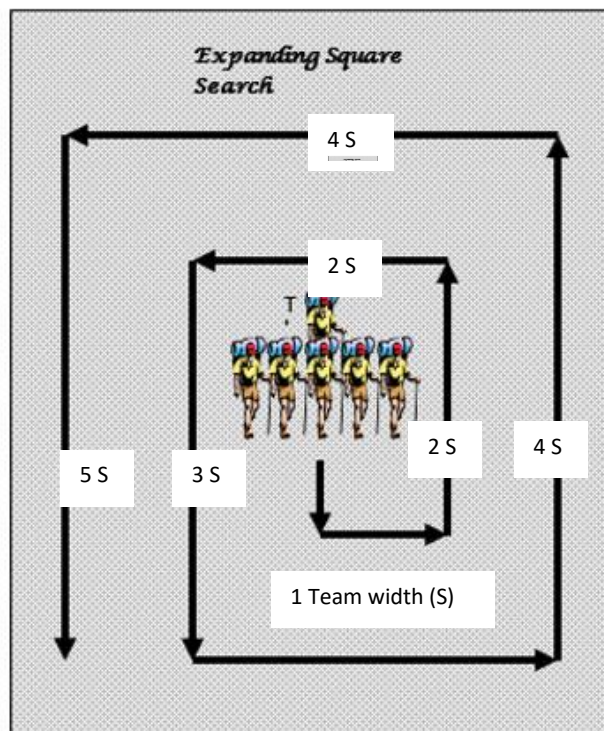

Figure 4-33 Expanding Square Search

Vehicle Search Patterns

- 4.15.77 The search patterns discussed so far are suitable for searchers on foot or horseback and may be adapted for use with vehicles. Vehicles can be a major asset to a search when they are used to patrol boundaries, firebreaks and tracks. Where the land is open for long distances, particularly in the drier, more barren regions, vehicles can be used to conduct sweeps across the land much the same as a foot team.
- 4.15.78 Visibility: A problem with vehicles travelling in formation is the loss of visibility owing to dust. This will be particularly prevalent in dry or arid conditions. When driving vehicles in dusty conditions, it will be necessary for following vehicles to travel outside the dust cloud of preceding vehicles.

Echelon Pattern

- 4.15.79 The most suitable method under these conditions will be to echelon to the right or left of the leading vehicle. The vehicles need to maintain a position just slightly in front of the dust cloud so as to have adequate vision and adjust their position to suit the circumstances.
- 4.15.80 If this method is adopted, the likelihood of vehicles colliding, striking obstacles or ditches, or becoming bogged is reduced.

Vehicles in Echelon

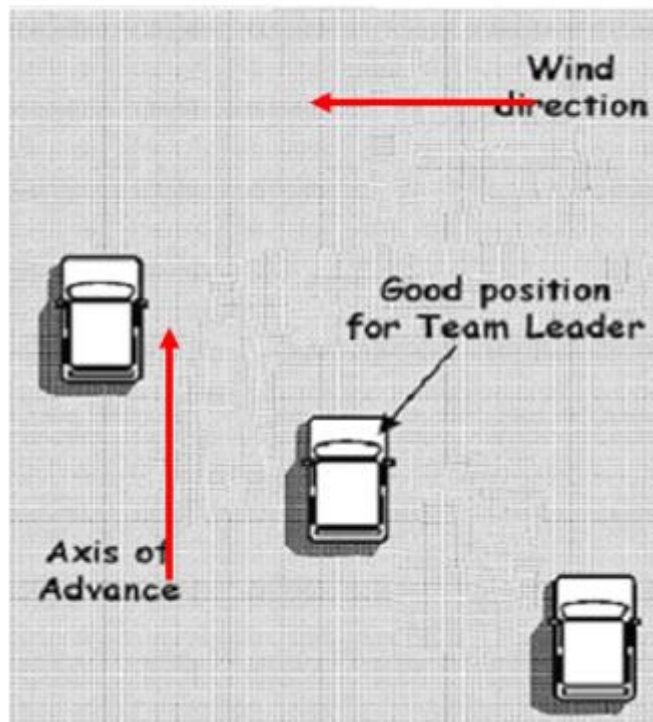

Figure 4-34 Echelon Pattern

- 4.15.81 The distance between the vehicles will depend on the terrain and the size of the object to be found. A general rule of thumb is that the bottom of the tyres must be able to be seen on the next vehicle. This will ensure that the vehicles are close enough to be able to see any missing person in between.
- 4.15.82 Searchers within the vehicle must be strategically placed to scan the ground. At no time must any searcher be placed externally to the vehicle, e.g. on the roof rack or bull bar, while the vehicle is in motion. Standing on the roof rack while using binoculars to scan the area is a valid technique while the ignition keys are removed from the ignition of that vehicle.
- 4.15.83 Each vehicle should have at least four personnel. The driver's role is to only safely navigate the vehicle. The passengers search where they are directed to by their team leader. The front passenger will search forward and 45° to each side. The rear passengers will search from 45° ahead to the rear on their respective sides.

Urban Search Patterns

- 4.15.84 Searching in an urban area can present some difficulties when it comes to determining which search pattern is best. Most of the above patterns are not suited to an urban environment and would present some safety hazards as members would be walking on roadways.
- 4.15.85 Urban searching requires houses, yards, industrial areas, vacant allotments as well as the drains, creeks, underpasses and associated urban hiding places being searched and cleared. To ensure each is done correctly and to ensure that all areas are covered they should be done systematically and methodically.

- 4.15.86 When searching a house (this can also include any dwelling, apartments, nursing or care facilities) it is important to ensure that all persons are outside and that no one enters except the searchers. One searcher will remain at a doorway to limit entry. Two further searchers (A male and female if possible as we search differently) will enter the house and search all the rooms in a circular direction, starting with the rooms on the left. Each individual room is then searched in a circular pattern, looking in, under and over every piece of furniture in the room. As a room is cleared the door should be closed indicating that it has been done. Once the house is cleared the doors should be closed or the owners allowed to return. It has to be remembered, that if the target person can leave the house then there is also a possibility that they could return. Re-searching the house should be done as the opportunity arises but at least twice daily.

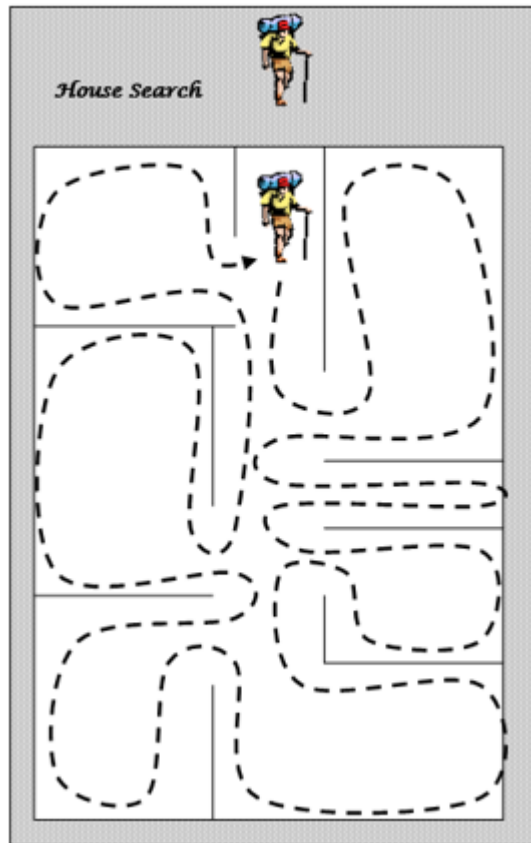

Figure 4-35 House Search

- 4.15.87 A similar pattern is adopted when searching a yard, vacant block or industrial area. One searcher remains at the entry point to prevent other from entering. One or more searchers clear the area in a circular pattern. This will enable to entire area to be searched to a high probability and also ensures that no areas are left unsearched.
- 4.15.88 As with the house search, it is necessary for every object of a size capable of hiding a person to be searched. All buildings, sheds, outhouses and even dog kennels should be checked. Searchers should be instructed to look under objects, over then and in them. They should also look behind at regular intervals to check the reverse sides of objects. While adults may find it difficult to hide in a yard a child can quite easily located a small nook and fall asleep while searchers pass by unaware. Where possible have a mixture of male and female searchers in teams, as their different search techniques will complement each other.

4.16.2 The following principles apply:

- a) Clue seeking is an ongoing process that starts with planning, continues throughout a mission and doesn't end until the debrief concludes.
- b) Clue seeking is a skill and must be practiced to develop a sense of what is the minimum information to work with.
- c) Avoid forming opinions and then gathering information to support that opinion.
- d) Don't immediately form an opinion about the value of a clue.
- e) Gather information from everyone, as no one person can adequately gather all the facts.
- f.) Assemble a complete profile of the missing target and the situation, and let it offer direction.

4.16.3 The theory of successful searching is dependent on clue detection and comprises five basic elements:

- a) Target or clue generator.
- b) Clues or messages.
- c) Search area.
- d) Searchers or clue seeker.
- e) Time, as it relates to a sequence of events.

Target or Clue Generator

4.16.4 **Targetor Clue Generator:** A lost person can become a prolific clue generator. The difficulty for searchers is separating these clues from those generated by other persons in the area. Strategic clues may suggest the period the person has been missing, their intent or destination. Tactical clues relate to clothing, equipment, footprints and discarded articles.

Clues or Messages

4.16.5 **Clues to be Sought:** Searchers should try to locate clues that provide the following messages:

- a) The present location of the target is
- b) The previous location of the target was
- c) The destination or intent of the target was
- d) The target was not here.

4.16.6 **Categories of Clues:** The categories of clues that searchers should seek are as follows:

- a) Physical (e.g., footprints, clothing, equipment or food wrappers).
- b) Recorded Information (e.g., a trip plan or trail register).
- c) Witnesses—People who knew of the intent or destination, or people who have seen the target, or other persons in the search area.
- d) Events (e.g. beacons, distress calls, flashing lights, smoke, fire, or noise such as a whistle).

Search Area

4.16.7 **Search Area:** Steps should be taken to contain the search area to reduce the number of clues that may be generated. Where clues are found outside a designated search area, it may be necessary to extend the search area.

Searchers or Clue Seekers

4.16.8 **Searchers or Clue Seekers:** The SMC needs to deploy the searchers or clue seekers throughout the search area and in particular, the most probable areas. A strategy is required to ensure that all clues are reported and assessed and pertinent clues are acted upon.

4.16.9 Clue detection demands intelligence, concentration and determination on the part of the searcher. The loss of concentration and fatigue may inhibit clue detection. Therefore the SMC should employ a redundancy principle with the searchers to ensure that searchers can maintain their effectiveness.

Clue Time Sequence

- 4.16.10 **Time Sequence:** Time as it relates to a sequence of events is very important. All clues found should be time-tagged by searchers to assist in the reconstruction of events. It is essential that a log be maintained at the FSH to record the time and locations that clues were located.
- 4.16.11 **Calculation of Search Time:** When evaluating the search time available from search assets, certain factors must be taken into account, where applicable:
- a) Total endurance of each SAR asset;
 - b) Transit time from FHQ or base to search area;
 - c) Necessary fuel reserves at final destination;
 - d) First and last light at departure and destination
 - e) Weather conditions in the search area, and destination points, and any requirement for holding fuel or alternate aerodrome for aircraft.
 - f) Any other operational limitations; and
- 4.16.12 In most cases, time in transit to the search area may be calculated using speed and the distance between the points of departure and destination and the mid-point of a search area.
- 4.16.13 Operational factors may limit the search time available from a specific aircraft, examples being the time at which an aircraft will become available, distance from mandatory servicing facilities, and other commitments of the operator that may require the return of an aircraft at a particular time.
- 4.16.14 **Investigation Time:** A search asset may sight objects that require investigation; therefore an allowance for the time taken to investigate must be made. The basic allowance is 15% of total time available in the search area, but the SMC may decide to increase this figure. The number of sightings investigated by previous search crews will influence any such decision. Unlike maritime searching, searchers in a land search remain in situ during any investigation and are generally ready to move on within a very short space of time. Investigation time is signified by the letter 'Z'.
- 4.16.15 When obtaining data about aircraft availability, special consideration should be given to the speed at which the aircraft will be flown whilst on search. In general, to provide for optimum scanning by observers, search aircraft should fly as slowly as possible. There are, however, other aspects to be considered, particularly the time available for search and the need to cover the area expeditiously. It may be beneficial to discuss these interacting considerations with operators. Some aircraft operate in excess of 120 kt when on search; although this is less than optimum, logistic considerations may dictate the use of these speeds.
- 4.16.16 Comparison of the search time required with that available will reveal whether the aircraft resources available are enough, too much or too little.
- 4.16.17 At this point, a critical decision related to aircraft allocation may be made. The time required for search is directly related to track spacing; track spacing, in turn, is directly related to search height. It is feasible, therefore, that despite first indications that insufficient resources are to hand, timely coverage of the whole search area could be achieved by the available aircraft for the sake of a higher-than-optimum search height.

4.17 Land Search Briefings

- 4.17.18 Briefing and debriefing is essential to the success of any search task. It would be difficult to locate a person if those involved are not correctly briefed as to what they are looking for and where they should be looking. It will also be difficult to identify and address issues that come to light if debriefing methods are ineffective. Searchers must understand their role and how to deal with any finds and other issues.

4.17.19 The two distinct parts to a briefing are:

- a) The preparation; and
- b) The conduct.

Preparation

4.17.20 Experience has proven that the selection of the best possible venue and the use of suitable aids will enhance the value of the briefing.

4.17.21 **Presentation:** The credibility of the briefing can be diminished if the briefing officer fails to project a professional approach.

4.17.22 **Venue:** The selection and preparation of the best venue available is vital for the delivering of information and retaining attention. Consideration should be given to:

- a) Large enough to accommodate all attendees comfortably.
- b) Open to authorised personnel only.
- c) Identified as a briefing area so that seating and display arrangements may be laid out in advance. This area may also function for media/public relations/briefings.
- d) Situated so there is minimum distraction by outside activities.

4.17.23 **Lighting:** Adequate lighting needs to be provided so that all present can see displays clearly and can take notes.

4.17.24 **Weather Protection:** Where possible, the briefing should be held in a covered location where protection from wind, rain or sun is provided. In field conditions, efforts should be made to ensure that the area is as protected as the circumstances allow.

4.17.25 **Briefing Aids:** The following may be considered for use during a briefing:

- a) **Maps**—A map will be required to show Team Leaders their areas of responsibilities and their relationship to other teams and activities. These may range from a topographical map to a map scratched on the ground. In any case, do not clutter the map with unnecessary detail. If possible, copies of the map should be provided to Team Leaders for their own reference and their subsequent briefings of their teams. If maps are not provided, time needs to be allowed at the end of the briefing for Team Leaders to make copies of their relevant sections.
- b) **Models:**
 - i) Map models take a long time to prepare and are generally of little use.
 - i) A mannequin similar in stature and dress to the missing person may be useful in some circumstances.
- c) **Photographs**—Attempt to obtain a recent photograph and circulate copies to searchers. If employing aerial photographs, ensure that those interpreting them are competent in their use. This style of photography may be very confusing to the uninitiated.
- d) **Display/Chalk Boards**—One of the most useful aids is the display/chalk board. If information is to be displayed using this system, ensure that it is kept out of sight until required. When the board is produced, ensure that it can be seen by everybody. To gain the most advantage from this medium, coloured chalks or pens should be used to highlight the display so as to make it as clear as possible. The briefing officer should explain clearly the information displayed.

4.17.26 **Conduct:** Once having prepared the venue and aids, the briefing must be conducted in such a manner that the briefing officer controls the activity.

4.17.27 **Sequence:** To ensure the briefing flows smoothly, observe this sequence:

- a) **Introduction** - The briefing officer should thank all for attending, and introduce him/herself. State his/her position and operational role. State the content of the briefing;
- b) **Visibility**—Ensure that all present can see the briefing officer, and any aids used;

-
- c) Notes—Ensure that everybody present has writing materials, and is prepared to take notes (writing materials should be on hand);
 - d) Maps - Maps should be issued before the start of the briefing so that they may be marked or referred to as the briefing proceeds;
 - e) Questions - Stipulate that there will be no questions or interruptions during the conduct of the briefing and that time will be made at the end for any questions. Regardless of circumstances, time must be allowed at the end for questions and answers; and
 - f) Topography - Before the briefing, it is necessary to describe the area where the teams will be operating. Ensure that all present can identify this location and can orientate themselves to the ground. The briefing officer should then explain all features relevant to or likely to affect the plan, including:
 - i) The terrain in the area;
 - ii) Difficulties in travel;
 - iii) Possible hazards; and
 - iv) Any other similar related information. Control features, such as start and finish points and boundaries, should be highlighted.

4.17.28 **Orders:** Operation orders are conveyed to those whose task it is to carry out the Search Commander/SMC's requirement. Such orders need to be:

- a) Correctly prepared;
- b) Presented in a systematic way to ensure those receiving the orders understand their tasks; and
- c) Re-examined as a result of information gained through debriefs.

4.17.29 Orders must:

- a) Be accurate;
- b) Be brief but clear;
- c) Contain all necessary information;
- d) Be capable of being actioned; and
- e) Be received in time to be acted upon.

4.17.30 **Land SAR SMEAC Layout of Orders:** Orders need to follow a logical sequence to ensure all aspects of the plan are covered. To achieve this, orders are divided into five main headings of:

- a) **Situation;**
- b) **Mission;**
- c) **Execution;**
- d) **Administration and logistics; and**
- e) **Command and communications.**

4.17.31 By employing the first letter of each heading, the catch-word SMEAC is derived.

4.17.32 **Situation (What has happened):** This gives the background of events in sequence (what has happened what is happening) and gives general details of the teams that will be employed.

4.17.33 This may include the following:

- a) Person/Object - Relevant details regarding the missing person or object.
- b) Topography - A general description of the search area using maps, sketches, air photographs, sand models etc.
- c) Other Search Teams Operating - The teams which share search boundaries with your area. Details include:
 - i) Identification; and
 - ii) Other relevant information as applicable.
- d) Additional Resources - Those which need to be available for the operation are:
 - i) Aircraft: fixed-wing and helicopters (if helicopters are available for support, give locations of known landing points in the search area);
 - ii) Vehicles;
 - iii) Dogs;
 - iv) Horses; and
 - v) Trackers.
- e) Own Resources - This is particularly important when briefing search teams from other areas who are not familiar with your procedure. This should include names of key personnel, layout of headquarters, medical and welfare facilities etc.

4.17.34 **Mission (What the task is):** The mission is a clear, concise statement of the task. It should begin with: 'Our mission is to'. This statement should be only one sentence long and needs to be repeated so that teams are sure of their task.

4.17.35 **The general land SAR mission is "To locate the target and remove them to a place of safety". As SAR is a two part operation, with both the search and rescue being intertwined any mission statement would require both parts to be met in order to achieve the aim.**

4.17.36 **Execution (How the task is to be accomplished):** This begins with an outline description of how the task is to be conducted, immediately followed by a detailed description of the roles and tasks of each team. To ensure that no relevant points are missed, these sub-headings should be used:

- a) General Outline - This is a short description of the overall conduct of the operation so all teams involved are aware of the broad picture; e.g. 'the search will be conducted in the areas shown and will involve six teams. Four teams will be employed in the initial search and two will be held in reserve. Should there be no result in this area, the search will be expanded'.
- b) Detailed Roles and Tasks - Each team will be given all the relevant instructions required so that the team may perform the allocated tasks:
- c) Role - A general statement is required. e.g. 'Team One will be searching the area marked A on the map'.
- d) Tasks - This should be used only where there is a requirement for a team to perform other tasks not described under its role; e.g. 'Team One, in addition to searching your allocated area, you will act as a radio relay between other search teams and this headquarters as required'.
- e) Method—It may be necessary to explain how the role will be performed; e.g. 'Team One, it is suggested that the creeping line ahead search method would prove suitable. Commence at the junction of the road and wire fence at (grid reference, and/or description), search to the north so as to finish at this point (grid reference and/or description). Pay particular attention to any heavy cover or heavily-grassed areas, make sure the boundaries of each sweep are clearly marked'.
- f) Boundaries—If boundaries are to be employed by search teams, they must either:

-
- i) Be clearly defined physical features (roads, fences, power lines); or
 - ii) Be marked by the teams as they progress.
 - g) Special Equipment - This will apply to special items allocated to specific teams, (details of equipment common to all should be detailed under the administration and logistics heading).
 - h) Co-ordinating Instructions - These are the details common to all teams by which the SMC maintains control of the operation:
 - i) All timings should be given in this block. If the operation is to proceed by phases or teams are to commence their tasks at differing times, this is where such timing should be specified.
 - ii) Movement/Navigation Details:
 - 1) To and from start/finish point;
 - 2) What routes will be employed;
 - 3) What method of transport will be employed (by foot, vehicle, aircraft, etc.); and
 - 4) Any specialised transport arrangements such as helicopter, to include landing and pick up zones.
 - i) Action If.....:
 - i) The operation is terminated before the planned finish time;
 - ii) The person is found uninjured;
 - iii) The person is found injured;
 - iv) The person is found dead;
 - v) A team member becomes injured; or
 - vi) A team member becomes lost.
 - j) Medical Casualty Evacuation - This details the procedure to be adopted for both team members and the missing person(s).

4.17.37 Administration and Logistics (What support will be provided and how): The following should be considered under this heading:

- a) Food and Water - If a meal will be provided before commencement (where and when). If water is to be carried by participants, how long it will be required to last.
- b) Re-supply - If re-supply of food, water or equipment in the field is planned, what the arrangements will be.
- c) Dress and Equipment - Directed initially at the individual member, then for the team (team items include first aid kits, stretchers, maps, compasses or any other equipment to be carried within the team).

-
- 4.17.38 **Command and Communications (Who will be in control and how the communications will function):** The following should be considered under this heading:
- a) Where is the headquarters is located?
 - b) Who is in charge of specific tasks and command structure?
 - c) Communications:
 - i) Radio net diagram;
 - ii) Type of radio to be employed;
 - iii) Primary and secondary frequencies;
 - iv) Call signs;
 - v) Radio net establishment times;
 - vi) Situation reports/radio schedule times;
 - vii) Code words (if situation requires);
 - viii) Method of notifying the conclusion of, or change to operation; and
 - ix) Synchronisation of watches.
- 4.17.39 Other methods of communicating in the field apart from radios may be employed. No matter what system is selected, all details must be given to ensure the effective functioning of the system.
- 4.17.40 **Issuing orders:** At the conclusion of a briefing, those persons required to be issued with orders should be directed to remain whilst others are released to continue with preparations. To ensure that orders are presented in a logical, detailed manner:
- a) Utilise the SMEAC system;
 - b) Read from prepared, sequentially-numbered pages;
 - c) Present the orders at a speed which enables attendees to write down pertinent information; and
 - d) Repeat the mission and all grid references to ensure clarity.
- 4.17.41 **Synchronisation of watches:** This should occur before taking questions.
- 4.17.42 **Questions from the teams:** To maintain control, it should be indicated that questions will be taken after a nominated period, (e.g. five (5) minutes). Then, the briefing officer should ask each Team Leader in turn, if there are any questions and then provide the answers.
- 4.17.43 **Questions to the teams:** Check that the briefing has been assimilated by directing questions to the Team Leaders about roles, tasks, boundaries, timings, call signs and other relevant information. The briefing officer should then indicate that the briefing has concluded and all participants may carry out their allotted tasks. Time should be allowed for Team Leaders to conduct a briefing of their team prior to commencing the search.
- 4.17.44 **Action on locating the missing person(s):** Prior to the deployment of search teams, the action to be taken in the event of a team locating the person must be defined and clearly understood by all searchers. This action must form part of the briefing to search teams.
- 4.17.45 **Code Word:** A code word, to be employed in the event that the person is found and believed to be dead, should be given. This will notify the SMC immediately of the situation and should be followed by the location of the team. The standard code words are:
- a) Door open: This is for an alive target
 - b) Door ajar: This is when medical attention is required.
 - d) Door closed: This is for a deceased target.
- 4.17.46 **Alive and uninjured target: If the target is located alive and well and not in any need of medical assistance they should be walked out from the location point back to the FSH for a debrief.**

-
- 4.17.47 **Alive and injured target: If the target is located alive but injured first aid should be administered as per the capabilities of the search team. If the injury requires professional medical assistance the FSH should be notified of:**
- Exact location
 - Nature of injury
 - Access for aerial assets
 - Medical equipment available at the scene
- 4.17.48 An informed decision by the SMC and medical professionals will be made to provide assistance as required. The SMC will activate the rescue plan and detail assets according to medical requirements.
- 4.17.49 **Deceased target:** The suggested action to be taken where a person is found dead is as follows:
- The searcher locating the missing person immediately informs the Team Leader who will make an assessment.
 - In the event that the person is believed to be dead, the Team Leader will ensure minimal disturbance of the immediate scene by instructing all members of the team to remain clear of that person, to a distance of approximately 30 metres. If possible the area should be marked off with tape or rope.
 - Only the Team Leader and a First Aid Qualified person will approach the body to check for pulse and breathing. It is essential that two people check the body to prevent mistakes.
 - In the event the person is alive all medical assistance possible will be given.
 - If the person is deceased, the finder and Team Leader will retrace their steps and maintain the cordon. All deceased persons and their locations are to be treated as Crime Scenes until advised otherwise by an investigating police officer.
 - As soon as practicable, the SMC and/or Field Headquarters should be informed using the assigned code word and arrangements made for the Police to attend that location.
 - The team will maintain the security of the scene until relieved.
- 4.17.50 It must be remembered that information transmitted through the radio network may be heard by many people including the media, relatives and friends of the missing person. Some of these people may already be in a distressed state and will be sensitive to any thoughtless comments on the condition of the missing person. Therefore, it is important that all searchers use the designated code word and think before passing their assessment on any person's condition through the radio network.

Mattson Consensus

- 4.17.51 Mattson Consensus: Determining which segments to search when there are not enough resources to cover the entire search can be daunting for any SMC, especially when there is pressure to get the job done. One aid that can spread the burden of this is the Mattson Consensus, although the ultimate responsibility will always rest with the SMC. The search area is divided into smaller search segments with each being given a letter or number. This letter or number is entered into the 'Search area' column of the table. The SMC then chooses a number of trustworthy persons, such as the SES Controller, a knowledgeable local, Park ranger etc., who then look at the various search segments. Each person independently determines the probability of the target being in each of the segments. There is always one extra segment, called 'The Rest of the World' or ROW which covers everywhere outside the search area.
- 4.17.52 Each of the people assign a number value to each segment with the highest value going the segment they believe the target has the greatest chance of being located in. There is no total value for this exercise. Adding across the table you arrive at the total for each of the search segments. Working out the percentage you can see that area C has the highest with a consensus of a 0.23 chance that the target will be in that area, with area B coming in second at 0.19. Area F and ROW are the least likely areas according to the consensus.

4.17.53 A Mattson Consensus Worksheet and full explanation can be found in Appendix E-9.

4.17.54 The SMC can now allocate resources according to the priorities as in the consensus, or can ignore it and go their own way.

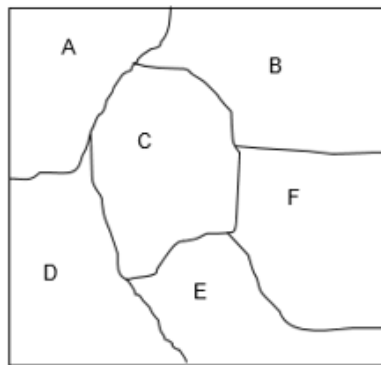

Figure 4-37 Search areas given letter for Consensus

	A	B	C	D	E	F	ROW	Total points
SMC	10	20	20	10	20	10	5	95
A/SMC	15	20	30	10	15	10	5	105
Local Cont	20	20	25	15	20	10	5	115
Total per area	45	60	75	35	55	30	15	315
Divided by total points	45/315	60/315	75/315	35/315	55/315	30/315	15/315	315/315
Percentage	14%	19%	23%	11%	17%	9%	4%	100%

Figure 4-38 Consensus Worksheet

Chapter 5 Rescue Planning Operations

5.1 Rescue General

- 5.1.1 The primary purpose of any SAR action is the speedy return to a place of safety of the survivors of a distress situation.
- 5.1.2 When planning and conducting SAR operations the safety of the search party members is also paramount. Safety is an essential aspect of every search operation, and as such, all participants have responsibility. It includes such factors as adequate and appropriate equipment and clothing, proper preparation of team members and skilled leadership.
- 5.1.3 It is essential that from the start of any SAR action, the coordinating SAR Authority plans for the rescue of survivors and ensures that the appropriate resources are alerted, briefed and positioned so that the rescue may take place with the minimum of delay after the location of the survivors. For every search plan there has to be a partner rescue plan.
- 5.1.4 Without jeopardising the ultimate safety of survivors, foremost consideration shall be given to the potential impact on any medical condition of survivors by the method of recovery or the actions of unqualified persons.
- 5.1.5 The method of rescue to be used shall be decided after consideration of all relevant factors including:
- a) Location of the survivors;
 - b) Action taken by sighting asset and the action that can be taken by other asset at the distress scene;
 - c) Condition of survivors and medical considerations;
 - d) Number of persons reported to be on board the target and number who have been located;
 - e) Environmental considerations;
 - f) Available SAR facilities and their state of readiness;
 - g) Effect of weather;
 - h) Time of day; and
 - i) Any risks involved to SAR personnel at a crash site e.g. dangerous goods.
- 5.1.6 To reduce delay, the SAR facilities that are likely to be used should be alerted and deployed to a suitable location while the search is still in progress. Pre-deployment should be considered taking into account the location and/or trackline of the incident.
- 5.1.7 It is the responsibility of the SMC to ensure that appropriate rescue resources are brought to a state of readiness and, as necessary, strategically positioned to be moved quickly into action immediately survivors are located.
- 5.1.8 The SMC shall ensure that proper attention is given to the preparation and execution of the rescue effort. Rescue assets should be included in the initial briefing even if they are not going to be immediately deployed.

5.2 Medical Assistance

- 5.2.1 It must be assumed that the survivors of an emergency will be in need of medical attention, and arrangements should be made to include medically qualified persons in the rescue team. Medical Factors are contained within Volume 2, Chapter 7 of this manual.
- 5.2.2 First Aid: Although many crashed aircraft or vehicles are located by helicopter it is not always possible to lower a paramedic or doctor to the scene. In other instances it will be a land search team who locates and arrives on scene first. In either instance it is vital that all land search teams contain one or more persons with a good knowledge for first aid and have a well-stocked first aid bag. First aid will most often be limited to immobilising broken bones, stemming blood loss and making the patient comfortable. CPR will not be required if it has been some time since the incident, unless the MP or victims suffer a problem in the presence of the search team. Although the actual first aid provided may be limited, the psychological value cannot be underestimated.

5.3 Aircraft Accidents

- 5.3.1 When it is known that an aircraft will crash or has crashed and the crash position is incidentally reported or known with reasonable certainty, the RCC shall confirm the crash site and ensure the provision of medical assistance to the occupants and rescue of survivors.
- 5.3.2 Police and the ATSB should be given early notification of a crash for a decision for their attendance at the crash site. Next of kin should be kept fully informed through the appropriate liaison channel; normally the police.
- 5.3.3 Pending assumption of the responsibility by ATSB or relevant military authority, the RCC shall endeavour to arrange security at the crash site to prevent interference with the wreckage or with marks made by the aircraft in landing. State police are responsible for securing the accident scene. Instructions for police officers and emergency services personnel can be found in the ATSB and Department of Defence handbook: Civil and Military Aircraft Accident Procedures for Police Officers and Emergency Personnel. (This publication is available on the National Search and Rescue Council website).

Health Hazards

- 5.3.4 Where practicable always approach an air crash incident from up wind. Movement in the vicinity of crash sites can be extremely hazardous for ground parties on account of toxic fumes, dangerous substances and explosives. Deaths have resulted from ground personnel breathing noxious air and contacting extremely poisonous substances in the proximity of wrecked aircraft.
- 5.3.5 Some points made in the ATSB/Department of Defence handbook are in Appendix D-8. Personnel should refer to the ATSB/Department of Defence handbook for more detailed procedures and precautions to be taken (see Section 5.3).
- 5.3.6 To the extent that it can be governed, the RCC shall advise that permission should be secured from the appropriate ADF authority before members of the public or other agencies approach a crash site of a service aircraft.
- 5.3.7 Modern aircraft use composite materials for some of their structure, skin, and access panels. Significant health hazards exist at crash sites from the effects of crash damage and fire on composite materials. When burnt, released fibres and resins may be toxic through inhalation and/or skin and eye contact. Damaged composites may also produce needle-like edges that render handling hazardous. Carbon fibres are electrically conductive and may short-circuit nearby electrical equipment.
- 5.3.8 Certain exotic metals (radioactive substances) can also be found in ADF aircraft types, which are also poisonous in their own right. The inhalation, ingestion or absorption of radioactive substances is hazardous, as low-level radiation will continue to be emitted inside the body, possibly resulting in damage to surrounding tissues and organs.

-
- 5.3.9 ATSB and CASA officers and police shall be given reasonable access to SAR facilities and staff during salvage operations.

5.4 Land Rescue

- 5.4.1 Although the location of the distress scene may be known, it may be extremely difficult for a land party to reach it. Therefore the operation should be undertaken only after proper and complete planning.
- 5.4.2 The rescue team should be taken to a locality as near as possible to the distress scene by some means of rapid transport. If access to the site is possible, an aerial survey of the site may be made to determine the best route. The equipment carried should be carefully selected and arrangements made for supplies to be dropped should re-equipment be necessary.
- 5.4.3 The SMC will determine equipment necessary for land rescue parties. A portable radio capable of communicating with other SAR Assets should always be included in a rescue party's equipment. JRCC Australia can authorise the issue of radios and other supplies from SAR stores for this purpose upon request.
- 5.4.4 In cases where all occupants of a crashed aircraft or vehicle are not immediately accounted for, the search for missing persons must be continued. In the meantime, activities for the rescue of the others should be started.
- 5.4.5 Advice to police officers, other emergency services personnel and the public of the necessary actions to be taken in the event of a civilian aircraft crash in their area is obtained from the ATSB publication, Civil and Military Aircraft Accident Procedures for Police Officers and Emergency Personnel.
- 5.4.6 The rescue team should make a report to the SMC as soon as possible.
- 5.4.7 The SMC will relay advice of the condition of persons on board and disposition of wreckage to other authorities as appropriate.
- 5.4.8 The aircraft wreckage should not be disturbed except to assist in the recovery of survivors. Not only may the wreckage pose dangers by way of toxic materials and fumes, but also the position of flight controls, the location of debris and other factors are important to the accident investigation.
- 5.4.9 Survivors should be removed from the distress scene and transported to receiving medical facilities by the most expeditious means. When selecting the method of transport, the SMC should consider:
- a) The condition of survivors;
 - b) The capability of the rescue asset(s) to reach the survivors in the shortest possible time;
 - c) The medical training, qualifications and operational abilities of the rescue personnel;
 - d) The rescue assets' capability to transport survivors without aggravating injuries or producing new complications;
 - e) The difficulties that may be encountered by land parties, e.g. provision of shelter;
 - f) The need for food and water (medical advice should be sought before giving anything to survivors);
 - g) The weather conditions; and
 - h) Methods of maintaining communication with the rescue party, either directly or through their organisation's operational office.
- 5.4.10 Evacuation of survivors will be relatively simple if they are located in an area where medical and rescue facilities are available locally and from where aerial, road or water transport is possible. However, if the distress site is in a difficult or inaccessible area, the evacuation will have to be made on foot to a place from where transport can be provided. This may require sufficient foliage to be cleared by the land party to allow helicopter operation into the site.

-
- 5.4.11 The overland route to be followed should be made known to the RCC. This will simplify the provision of aerial coverage, if this is considered necessary.
 - 5.4.12 If it is decided to evacuate the survivors by air, the rescue team may provide advice of a suitable landing area for fixed wing aircraft or a landing or hovering site for a helicopter. If verbal communication is not possible, the land party should prepare the appropriate ground/air visual signals.
 - 5.4.13 ATSB should be given early notification of a crash for a decision for their attendance at the crash site.
 - 5.4.14 Next of kin should be kept fully informed through the appropriate liaison channel; normally the police.

Avoidance of Danger

- 5.4.15 All members have a responsibility for safety. In the event of a dangerous situation developing, all activity must cease until the problem is resolved.
- 5.4.16 **Accidents and injuries to rescue personnel:** In the event of an accident or injury to rescue personnel (either on roads or in the field), it is the team leader's responsibility to report the incident to the SMC, and to decide on the appropriate course of action.
- 5.4.17 Personal injury from unsafe practices is a threat to searchers and may jeopardise the operation. Where possible any hazardous or dangers condition should be included in the briefing and actions taken to mitigate where possible (Specialist personnel, PPE, waiting until daylight etc.). Training programs must include lectures and information on safety, hazardous situations and hazardous materials.
- 5.4.18 Night search training should be carried out in safe areas, with checks made beforehand as to the extent of hazards in the training area.
- 5.4.19 Operational Safety: The team leader must keep a firm control of the team, ensuring:
 - a) A written list of team members is carried and frequent checks are made to confirm all personnel are accounted for.
 - b) Members are aware of the search orders.
 - c) All personnel are aware of field signals.
 - d) Members are observant and always maintain contact with their team.
 - e) The capabilities and pace of all members is considered; and
 - f) That appropriate care is taken, having regard to the prevailing conditions.

In the interests of safety, all team members must obey orders given to them by the team leader.

5.5 Maritime Rescue

- 5.5.1 The SMC is responsible for the coordination of surface vessels engaged in the rescue of survivors in or on the sea. Both the JRCC and Police are responsible for rescue at sea, with the first alerted assuming initial responsibility to coordinate a response prior to transfer to the best placed authority to take overall coordination if required, IAW IGA para 5.1 III (NATSARMAN Appendix A) and NATSARMAN Appendix B.
- 5.5.2 The RCC shall make flotation equipment available for use by survivors whilst awaiting transportation to the shore. Details of the availability and types of equipment held by SAR Resources and Training, AMSA may be obtained from JRCC Australia.
- 5.5.3 When an aircraft has ditched, or a vessel is in danger of sinking, or sunk, it is imperative that rescue action is taken immediately. The time that a marine craft will float may be very limited,

entry to life rafts is difficult, especially for children, aged or infirm personnel in rough seas, and the sea is a hostile survival environment.

- 5.5.4 When both maritime rescue assets and helicopters are dispatched to the same distress scene, it may be advisable to transfer survivors to the helicopters for a more rapid delivery to medical facilities.

Use of Rescue Boats and Vessels

- 5.5.5 Specialised rescue vessels are available only in scattered localities and their capacity is small. Each vessel dispatched to a distress scene should, if possible, carry additional life-saving devices to enable those survivors, who cannot be rescued immediately, to stay afloat while awaiting the arrival of another asset.
- 5.5.6 If specialised rescue assets or vessels are not available, merchant vessels may be the only means of implementing an early rescue. However, if possible, support or alternative rescue assets should be considered because merchant ships have significant limitations as a rescue platform, including:
- Generally not readily available;
 - Relatively slow speed;
 - Restricted manoeuvrability;
 - High freeboard, making retrieval of survivors difficult;
 - Small crew numbers; and
 - Language difficulties if foreign-crewed.
- 5.5.7 Ocean oil rigs and production platforms maintain fixed positions for periods of time. The JRCC Australia maintains data on their positions and means of contact for SAR purposes.
- 5.5.8 It is desirable that SAR vessels be equipped to lift survivors from the water without expecting any help from the survivors.

Marking Targets

- 5.5.9 Where rescue of maritime survivors is delayed it may be necessary to track their position by dropping visual or electronic aids, which have long and short term characteristics.
- 5.5.10 Long-term devices include:
- EPIRBS, which are packed in life rafts, transmit both a 406MHz digital identification code and a final stage homing signal on 121.5 MHz;
 - Self-Locating Datum Marker Buoys using the Iridium System;
- Note:** the buoys are colour coded for ease of identification. Details of each buoy deployed are recorded and passed to JRCC Australia.
- See-Blitz Strobe light. Provides a white strobe light for 4 – 5 hours.
- 5.5.11 Short term devices include:
- Marine Location Markers (Orange smoke markers); and
 - Sea Marker Dye.

5.6 Rescue Assets

Use of Aircraft for Rescue

- 5.6.1 When considering the use of aircraft to bring about the recovery of survivors, care must be taken to ensure that the rescue aircraft and crew are not exposed to inordinate danger.

-
- 5.6.2 Fixed wing aircraft should only be used to retrieve survivors when there is significant advantage over the use of surface transport and when there is a suitable aerodrome or landing area near the scene. Pilots shall be discouraged from attempting to land at other than prepared landing areas to pick up survivors. However, should this prove to be the best or only viable option, all available specialist advice concerning the operation shall be obtained. It may be possible to have a qualified person lowered or parachuted in to survey the area. Helicopters may be employed to shuttle survivors from a distress site to a suitable fixed-wing landing area.

Use of Helicopters for Rescue

- 5.6.3 When available, helicopters should be considered for rescue work. While eminently suited to the task in many respects, helicopters do have specific limitations that may be summarised as:
- a) The adverse effects of turbulence;
 - b) The need for a level, or near level, landing area;
 - c) A requirement for a cleared landing area of specific dimensions to avoid rotor blade damage;
 - d) A requirement for safe approach and take-off paths;
 - e) Potential for adverse effects on certain serious injuries;
 - f) Limited endurance;
 - g) Inability to hover with loads at high altitudes; and
 - h) Limited accommodation.
- 5.6.4 Helicopters can be used to rescue survivors by winching or by landing at a suitable location. Owing to their unique flying characteristics, helicopters should be considered for use as a rescue asset as a matter of course.
- 5.6.5 They are particularly suitable for rescues at locations where surface assets are unable to operate. At the same time, some helicopter evacuations may be hazardous, particularly in mountainous areas at high altitudes and over rough seas. Such evacuations should therefore only be carried out by specially qualified and experienced crews and then only in the event of serious injury or illness or when lack of other means of rescue might result in loss of life. It is important that any information on the condition of survivors is considered by specialists before committing to helicopter use.
- 5.6.6 Operations by rescue teams may be hampered by the noise and rotor wash produced by helicopters. To avoid damage to rotor blades, the landing site should be cleared to a diameter specified by the pilot-in-command for each proposed operation. To facilitate the coordination between helicopters and surface rescue teams and to minimise the hazard of collision associated with helicopters operating in a confined space during rescue operations, their operations should be carefully planned by the RCC and coordinated by the OSC in communication with them.
- 5.6.7 The helicopter's mass may be a factor limiting the number of survivors that may be taken aboard each trip. It may, therefore, be necessary to reduce weight by all possible means, e.g. removal of non-essential equipment, minimum fuel, use of advance bases with fuelling capabilities, etc.
- 5.6.8 It must be ensured that the route followed by the helicopter as well as the location where the survivors are to disembark are known to the SMC.
- 5.6.9 A medically qualified person, medical equipment and respiratory equipment, when available, should be carried on a helicopter recovery mission, at least on the first flight to the distress scene.
- 5.6.10 When being rescued by helicopter, survivors in a life raft may have to leave the raft to catch the sling since the rotor downwash below the helicopter will blow the raft away.

-
- 5.6.11 Survivors may not know how to operate a strop. A two-person winch is preferred to a single winch. A double strop allows one rescuer to supervise while being winched down and up again with each survivor.

Note: A helicopter should not be approached unless directed and/or escorted by a member of the helicopter's crew. Helicopters may require approach from different aspects dependent on type.

Use of Top Cover Aircraft with Rescue and MEDEVAC Helicopters

- 5.6.12 Refer to 'Top Cover Aircraft'

5.7 Supply Dropping and Delivery of Survival Equipment

- 5.7.1 Situations will arise where the immediate recovery of survivors is not possible and arrangements will have to be made to deliver sustenance, medical and survival equipment. Such situations shall be anticipated and planned for by the SMC during the conduct of a search.
- 5.7.2 Where possible delivery will be by way of-vehicle, vessel, helicopter or aircraft landing nearby. An example of this would be a situation with seriously injured survivors who may need stabilising prior to being moved or where specialised evacuation vehicles/vessels/aircraft needed are not immediately available.
- 5.7.3 Supply of survival equipment by air should be considered where there is an expected delay in the recovery of survivors from remote locations either at sea or on land.

Civil SAR Equipment

- 5.7.4 The inventory of Civil SAR Equipment provided by AMSA includes:
- a) Six person droppable Marine Life Rafts;
 - b) Droppable Stores Containers, Marine Supply Containers, Light Stores Canisters and the Small Payload Delivery System for the supply of communications, sustenance, medical and survival equipment;
 - c) De-watering Pumps;
 - d) Self-Locating Datum Marker Buoys;
 - e) Target marking devices including SAR Datum Buoys, See-Blitz Strobe, Lights, Smoke Markers and Sea Marker Dye; and
 - f) Search and Rescue Communicators (SARCOM) emergency AM transceiver operating on either the aviation band of 123.1 MHz or marine band Ch16 that are suitable for dropping in Droppable Stores Containers, Marine Supply Containers, Light Stores Canisters and the Small Payload Delivery System. Droppable Life Rafts are also equipped with these transceivers.
- 5.7.5 AMSA staff are familiar with the type and disposition of Civil and ADF SAR equipment and its usage and can be contacted for advice
- 5.7.6 Only suitably qualified, trained and equipped crews shall be tasked for supply dropping.
- 5.7.7 Aircraft tasked for supply dropping will be suitable for the purpose. It is the aircraft operator's responsibility to ensure the appropriate flight manual supplements / flight manual limitations and dispensations are held. Routinely such dispensations will be against:
- a) Civil Aviation Act Section 23 (Carriage of Dangerous Goods);
 - b) Civil Aviation Regulations 175(3) (IFR Flight); and
 - c) Civil Aviation Orders 29.5 (Dropping of articles from aircraft).

Supply Drop from Aircraft over Sea

- 5.7.8 The following can be delivered from suitable fixed wing aircraft, including ADF aircraft:
- a) Light Stores Canisters or Marine Supply Containers containing communications, sustenance, medical and survival equipment etc.;
 - b) One or more single Life Rafts;
 - c) One or more multi-asset drops consisting of two Life Rafts or a combination of Life Raft and Marine Supply Container linked by 400 metres of buoyant rope; and/or
 - d) De-watering Pumps.

Supply Drop from Helicopter over Sea

- 5.7.9 If recovery by helicopter is not feasible, or if recovery can be assisted by the supply of equipment such as rafts, a helicopter may be able to deliver a Life Raft using the Helicopter Delivery Line System or lower a Life Raft, Stores Container or De-watering Pump to survivors with great accuracy. Due to the limited capacity of some helicopters, not all survivors may be rescued at one time in which case the provision of additional floatation equipment (Life Rafts, Life Jackets) may be necessary to support the remaining survivors.

Supply Drop from Aircraft over Land

- 5.7.10 Where it may take too long to get to survivors by land, stores and equipment can be dropped from civil or ADF aircraft. The main method of delivering supplies to survivors on land from fixed wing aircraft is by Droppable Stores Containers, Light Stores Canisters or the Small Payload Delivery System. All these methods can contain a combination of food, water, blankets, transceivers and medical equipment. In situations where it is important to provide survivors with shelter, it may be appropriate to drop one or more life rafts using a Bag – Storage or Deployment MkII and Parachute. Where there is no suitable landing place close to the survivors, vital survival equipment, food and stores could also be winched or dropped from a helicopter with great accuracy.

Chapter 6 Conclusion of SAR Operations

6.1 Conclusion General

- 6.1.1 SAR operations enter the conclusion stage when:
- a) The target is located and the survivors are rescued;
 - b) The emergency beacon has been located and the survivors rescued, or if there was no distress, the beacon has been turned off;
 - c) Information is received that the target is no longer in distress;
 - d) All known persons on board are accounted for, or it has been determined that there is no longer a chance of survival (time frame for survival has been exceeded based on medical opinion); or
 - e) The SAR Authority determines that further searching has no significant chance of succeeding and either suspend or terminate the search.
- 6.1.2 The authority to end a search rests with different levels within the SAR organisation, depending on the circumstances. In particular, the SAR Authority is responsible for deciding when to suspend or terminate an unsuccessful search where lives were known to be at risk.
- 6.1.3 The SAR Authority may delegate to the SMC the authority to conclude the operation in all other circumstances (i.e. when the SMC determines that the target is no longer in distress and in situations where an identified beacon has ceased transmitting).

6.2 Conclusion of a successful SAR operation

- 6.2.1 When the target of a search operation has been located and the survivors removed to a place of safety, the SMC shall ensure:
- a) All people and organisations involved in the SAR operation are stood down;
 - b) All appropriate agencies are notified;
 - c) Next of kin are fully informed;
 - d) Shipping is advised of any hazard caused by abandoned vessels etc.;
 - e) Arrangements are made for the recovery of dropped survival equipment e.g. rafts;
 - f) The collection of all maps, charts, overlays, worksheets, logs, notes, messages in chronological order and filed on a SAR incident file; and
 - g) That administrative and financial procedures are completed.

6.3 Suspension/termination of a search when the target is not found

- 6.3.1 When it is determined that further search would be of no avail, the SMC shall consider recommending the suspension or termination of the SAR operation. However, a search operation shall not be suspended or terminated, nor the distress phase cancelled without the specific concurrence of the SAR Authority.
- 6.3.2 The decision to suspend a search shall not be made until a thorough review of the search is conducted. The review will focus on the probability of there being survivors from the initial incident, the probability of survival after the incident, the probability that the survivors were in the search area, and the effectiveness of the search.
- 6.3.3 The review should:
- a) Examine search decisions to ensure that proper assumptions were made and that planning scenarios were reasonable;

-
- b) Reconfirm the certainty of initial position and any drift/ lost person behaviour factors used in determining the search area;
 - c) Re-evaluate any significant clues and leads;
 - d) Examine datum computations and data calculations;
 - e) Confirm that all reasonable means of obtaining information about the target have been exhausted;
 - f) Review all intelligence material to ensure no information was overlooked;
 - g) Examine the search plan to ensure that:
 - i) Assigned areas were searched;
 - ii) The probability of detection was as high as desired; and
 - iii) Compensation was made for search degradation caused by weather, navigational, mechanical or other difficulties;
 - h) Consider the survivability of the survivor/s, taking into account:
 - i) Time elapsed since the incident;
 - ii) Environmental conditions;
 - iii) Age, experience and physical condition of (potential) survivors;
 - iv) Survival equipment available; and
 - v) Studies or information relating to survival in similar circumstances;
 - i) Consider the rescue plan to ensure that:
 - i) Best use was made of available resources;
 - ii) Contingency plans were sufficient to cater for unexpected developments; and
 - iii) Coordination with other agencies was effective in ensuring best treatment of survivors.
- 6.3.4 Before an unsuccessful search is suspended or terminated, the SAR Authority shall make arrangements to ensure that the next of kin are fully briefed on the complete search effort, including conditions in the search area, other salient operational factors and the reasons for proposing the suspension or termination of the search.
- 6.3.5 Consideration may be given to notifying the next of kin of the decision to suspend or terminate search effort at least one day prior to suspension of operations. This provides the next of kin at least one more day of hope while giving them time to accept that the search cannot continue indefinitely. Accordingly, the SMC should maintain regular contact with the relatives during the conduct of the search, providing access to the RCC if practical and appropriate.
- 6.3.6 In a case where foreign nationals are involved, liaison shall occur with the Department of Foreign Affairs and Trade.
- 6.3.7 The reasons for suspending a search shall be clearly recorded.
- 6.3.8 When a SAR operation is discontinued or a search is suspended, the SMC shall inform all authorities, assets and facilities that have been activated and/or alerted.
- 6.3.9 On occasions, after the suspension/termination of a search for a live target, it may be necessary for the Police or Defence to continue to search for bodies and/or aircraft/vessel wreckage. In such cases the SAR Authority that had responsibility for the coordination of the search and rescue operation may, where possible:
- a) Provide briefings on the path of the person/aircraft/vessel prior to disappearance, last known position, area searched and related intelligence;

-
- b) Review intelligence to assist search;
 - c) Source aircraft for transport or search purposes; and/or
 - d) Provide drift information.
- 6.3.10 Should any other organisation, such as the operating company, wish to continue with or initiate an independent search, the SAR Authority that had responsibility for the coordination of the search and rescue operation should ascertain whether there is any new intelligence that provides grounds to resume or continue the search. Under the circumstances where there is new intelligence, it should be evaluated and if considered valid the search should be continued or resumed. Where there is no new intelligence, then the SAR Authority may assist the requesting organisation by:
- a) Briefing the person/aircraft/vessel's path prior to disappearance, LKP/splash/crash point, area searched and related intelligence;
 - b) Advising the possible location of suitable search aircraft; and/or
 - c) Providing drift information.
- 6.3.11 There are instances where family members are not satisfied with the search efforts prior to suspension/Termination and wish to continue the search using their own funds and/or assets. In these instances, the SAR authority that had responsibility for the coordination of the initial operation should provide assistance with:
- a) Providing details of what searching had been undertaken;
 - b) Advising of possible suitable search assets; and/or
 - c) Providing drift information.

6.4 Reopening a Suspended Search

- 6.4.1 If significant new information is received, reopening of a suspended case should be considered. An evaluation and assessment of the new intelligence is necessary, as is assessing the value of any further searching. Reopening without good reason may lead to unwarranted use of resources, risk of injury to searchers, possible inability to respond to other emergencies, and false hopes among relatives.

6.5 Records and Reports

- 6.5.1 Records relating to search and rescue operations, including air searches on behalf of other organisations, shall be retained for periods as required under the relevant legislation and regulation.
- 6.5.2 When a search has been terminated or-suspended without locating the target or its occupants, all records, charts etc. shall be retained and be accessible to SAR staff to allow easy resumption of search activity should further intelligence be received.
- 6.5.3 Reports on SAR operations shall be generated as required for Coroners Inquiries, Management purposes and for training requirements.

6.6 Incident Debriefs

- 6.6.1 Following any SAR incident the conduct of a debrief of agencies and groups involved should be considered. The purpose of incident debriefs are to establish opportunities for improvement in the operation of the national SAR system.

-
- 6.6.2 Incidents worthy of debrief may include those where:
- a) Lives have been lost;
 - b) Large and complex searches have been conducted;
 - c) Multi agency involvement occurred; or
 - d) Where coordination, communication or response challenges were experienced during the incident.
- 6.6.3 This list is not exhaustive and the conduct of a post incident, multi-agency debrief is at the discretion of the SAR Authority in overall coordination of the incident with mutual agreement of other SAR Authorities and agencies involved.
- 6.6.4 Post incident debriefs should be used to:
- a) Establish opportunities for improvement in the operation of the National SAR System; and
 - b) Ensure current policies and procedures are appropriate.
- 6.6.5 The SAR Authority with overall coordination is to:
- a) Decide the need for a debrief in consultation with other SAR participants;
 - b) Organise and host the debrief unless otherwise agreed by the participants;
 - c) Establish a venue that maximises opportunity for participation in, and learning from, the debrief;
 - d) Capture and share the opportunities for improvement arising;
 - e) Initiate changes to the National SAR Manual as appropriate arising from the debrief; and
 - f) Include lessons learned from debriefs in their jurisdiction reports to the annual National SAR Council meeting.
- 6.6.6 No matter how simple or complex the operation may be, it cannot be concluded until a debrief has been conducted.
- 6.6.7 This is the primary method employed to assess the effectiveness of the plan, and for Team Leaders to assess their own conduct.
- 6.6.8 Depending on the size of the activity and/or the number of participants, there may be different types of debriefings:
- a) At the end of each phase of the operation. This is to update information and revise plans for subsequent phases.
 - b) By the leaders of individual teams to determine the effectiveness of their training and/or operating procedure and the conduct of their allotted tasks.
 - c) A debrief by the SMC of everyone involved in the conduct of the operation prior to the conclusion.
 - d) After the initial information has been analysed and the control element has had time to study all the records and data relevant to the activity.
- 6.6.9 Provided the debrief is conducted correctly, many valuable lessons may be learnt which may be applied to the conduct of the immediate operation and may be incorporated into future plans and procedures. A poorly conducted debrief may not only fail to achieve its aim, but also have negative effect on those participating.

Conducting the Debrief

- 6.6.10 The points discussed in briefing are just as relevant in debriefing. However, the debriefing officer needs to do the following:
- a) Control the debrief and not allow it to degenerate into a witch hunt.
 - b) Stress that the aim of the debrief is to examine the operation to determine what went right, what went wrong, and why?
 - c) Address specific questions, such as:
 - i) Accuracy of maps and charts (paper and electronic)
 - ii) Terrain, sea conditions and state, weather
 - iii) Suitability of search method,
 - iv) Effectiveness of communication system,
 - v) Resupply, and
 - vi) Any other related subjects.
 - d) Identify good points and make special mention of them. People prefer to be praised rather than criticised. No matter how often it is stressed that the debrief is not a witch hunt, somebody will believe that they are being criticised, either personally or on behalf of the organisation they represent. Be aware that this will occur.
 - e) Seek comments from those being debriefed. Once the major points have been identified, ask for any comments. Maintain control by employing the same system as that used during the briefing. Stress that the information being sought is constructive criticism that will be employed to improve the conduct of operation in the future.
 - f) Take written notes. Not only does this ensure that all points are recorded for future use, it will also allow those being debriefed to observe that a genuine effort has been made. Further comments may not be forthcoming unless it is noted that relevant points are recorded.
 - g) Read out a summary of the points discussed to confirm that they have all been addressed.
 - h) Issue confirmatory notes to all organisations detailing all points discussed and what actions need to be taken.
- 6.6.11 Participation at debriefs may be restricted to particular SAR Authorities and agencies depending on the issues that are likely to arise and would be a decision for the SAR Authority with overall coordination for the incident.
- 6.6.12 SAR Authorities that participate in the debrief will meet their own attendance costs, unless otherwise agreed by the participants.
- 6.6.13 The debrief should include the opportunity for all significant parties involved in the incident to contribute and learn from it.

Lesson for improvement

- 6.6.14 Constant improvement in the performance of the SAR system should be a clearly stated goal of SAR managers. One method to encourage performance improvement is to set up goals whose degree of attainment can be measured by key performance data. This data should be collected, analysed, and published on a routine basis so that individuals can see how the system as a whole is doing, and how their performance is contributing to the achievement of the established goals. Routine reports from the SMCs to the SAR managers can be used for monitoring system performance and highlighting areas where improvement is possible through changes in policies, procedures, or resource allocation

6.7 Case Studies

- 6.7.1 Case studies may be conducted at the direction of the SAR Authority. IAMSAR provides guidance on case studies as follows.
- 6.7.2 Sometimes a SAR case has a surprise ending, as when the survivors are found by someone not involved in the search effort in a location outside the search area, or they are found, alive and well, in the search area after the search effort has been suspended. There are also occasions when there seems to have been an unusual number of problems in spite of the best efforts of the SAR personnel. Finally, there may be important and valuable lessons to learn from a SAR incident and the subsequent response of the SAR system that would be revealed only by a careful after-the-fact review.
- 6.7.3 A SAR case study is an appropriate method for addressing those aspects of an incident that are of particular interest. Individual aspects of interest could include problems with communications, assumptions made, scenario development, search planning, or international co-ordination. SAR case studies or incident reviews also provide opportunities to analyse survivor experiences and lifesaving equipment performance. Survival in hostile environments is affected by many variables, including the physical condition of the survivors, survivor actions, reinforcement given by rescue crews prior to rescue, and the effectiveness of safety or survival equipment. Knowing more about these factors can help the SAR system become more effective.
- 6.7.4 When used to review and evaluate all aspects of a response to an incident, SAR case studies are one of the most valuable and effective tools for improving SAR system performance. Therefore, SAR case studies or reviews should be performed periodically even when no problems are apparent. There is almost always room for improvement, especially in large, complex cases. The most important outcome, however, is that early detection and correction of apparently small problems or potential problems will prevent them from growing into serious deficiencies later.
- 6.7.5 To get a balanced view, more than one person should conduct SAR case studies.
- 6.7.6 The case study team should include recognised experts in those aspects of the case being reviewed. To achieve maximum effectiveness, case studies should not assign blame, but rather, should make constructive suggestions for change where analysis shows that such change will improve future performance.

6.8 Peer Reviews

- 6.8.1 A Peer Review is a formal structured review of a SAR incident prior to it going forward to the Coroner or an inquest.
- 6.8.2 The review is designed to provide a comprehensive overview of the SAR incident in-line with the requirements identified earlier in this chapter. A review will focus on the following:
 - a) The incident situation
 - b) The National SAR Arrangements
 - c) Assessment of the survivability of the incident
 - d) Assessment of the Last Known Position (LKP) or Splash Point (SP)
 - e) Assessment of the Search Plan
 - f) Assessment of the Time Frame for Survival (TFFS) and Probability of Detection (POD)
 - g) Assessment of the Rescue Plan
 - h) Assessment of intelligence, information, clues and leads
 - i) Conclusion
 - j) Recommendations

-
- 6.8.3 A Peer Review may be initiated by the SMC, in-line manager, SAR Authority or Coroner. A Peer Review should be undertaken by a Senior SARO or other suitably qualified SAR person that had no involvement in the original incident. This may include seeking assistance from another SAR authority.
 - 6.8.4 A suggested Peer Review format is contained in Appendix E-16 of this manual. This form should be used as a guide to ensure coverage of all aspects of the SAR incident.
 - 6.8.5 Any recommendations made as a result of the review should be considered by the relevant SMC and SAR Managers. This may involve further searching to increase the POD, following up of clues and leads or seeking assistance from external agencies for inquiries.
 - 6.8.6 A Peer review is a means of identifying shortfalls in the SAR incident, training, policy or procedures that can be addressed through amendments to the manual and procedures or improved training. It is also a means of identifying the strengths within the SAR system or directions in which further work can be undertaken.
 - 6.8.7 Issues relating to this manual or SAR training should be directed through the relevant SAR Authority for discussion by the National SAR Council.

Chapter 7 Medical Factors

7.1 General

- 7.1.1 The SMC must be aware of the potential medical factors that may have an impact on the survivability or otherwise of the target persons.

7.2 Time Frame for Survival (TFFS)

- 7.2.1 The time-frame for survival is an assessment of the minimum and maximum period a missing person is likely to live. This assessment is subjective and contains numerous variables including the physical condition of the person, their age, general health, clothing, weather conditions, the ability to remain dry, and their consumption of food, water and alcohol. There are a number of medical conditions that go hand in hand with search and rescue missions. These can be loosely divided into cold weather problems and hot weather problems. We will touch briefly on both of these topics to give you, as a co-ordinator, a basic understanding and awareness.

7.3 Survivor Stress Factors

- 7.3.1 Two basic assumptions are to be made concerning survivors of a distress incident:
- a) There are always survivors who require emergency medical care; and
 - b) They are under a condition of great stress and experiencing shock.
- 7.3.2 It may also be assumed that not even able-bodied, logical-thinking survivors will be able to help themselves.
- 7.3.3 Records include numerous accounts where supposedly able-bodied, logical-thinking survivors failed to accomplish extremely simple tasks in a logical order, and thus hindered, delayed or even prevented their own rescue.
- 7.3.4 This is due to shock that, following an accident, is often so great that even those of strong mind think and act illogically. All survivors will be in some degree of shock. Some may be calm and somewhat rational, some may be hysterical and in panic, while the remainder will be temporarily stunned and bewildered.
- 7.3.5 This last group will generally have passive attitude and can be easily led during the first 24 hours after the incident. As the shock wears off, most of them will develop active attitudes. Those that do not develop active attitudes will die unless rescued quickly.
- 7.3.6 Individuals who observe an emergency situation and who are reporting it to the SAR system should also be considered as being under stress. It will be necessary for SAR personnel to specifically request essential information from an individual reporting an emergency, as it may not be forthcoming. This situation should be expected, and SAR personnel should be prepared to cope with it.
- 7.3.7 Persons assessing a time frame for survival must recognise the limitations of such an assessment and not regard it as an arbitrary period for survival. The following subsections may assist in providing a guide to assist in search planning.

7.4 Survival Environment Factors

- 7.4.1 The environment in which the survivor is exposed is another factor that limits the time available to complete their rescue. In some cases, environment will be the most time critical of all. Climatic atlases are useful to evaluate probable climatic conditions in regions where few or no weather reporting facilities are available.
- 7.4.2 The relation of survival time to water temperature, air temperature, humidity and wind velocity is not a simple one. These and other factors often exist in combination to complicate the problem of estimating life expectancy of survivors. Individuals will vary in their reaction to cold and heat stresses.
- 7.4.3 Additional factors which will vary a survivor's life expectancy include the type of clothing worn, the clothing's wetness, the survivor's activity during their exposure, initial body temperature, physical conditions, thirst, exhaustion, hunger, and various psychological stresses such as isolation, loneliness and remoteness, and the all-important individual will to live.
- 7.4.4 The graphs contained in this chapter are provided to assist the SMC in determining the urgency required to remove survivors from the environment, and to assist in evaluating the practicality of terminating a search. These graphs are based upon case histories, field tests, laboratory experiments and analysis of all known data. However, the SMC must understand that some individuals will exceed the life expectancy or tolerance times indicated in these figures, and therefore should consider these figures as helpful guidelines rather than absolute controlling factors.

7.5 Hypothermia

- 7.5.1 Hypothermia is the abnormal lowering of internal body temperature (heat loss) and results from exposure to the chilling effects of cold air, wind or water. Death from hypothermia may occur in both land survival and water survival situations. Hypothermia is the leading cause of death for dementia suffers located deceased after being reported missing.
- 7.5.2 Internal body temperature is the critical factor in hypothermia. If the body temperature is depressed to only 35°C, most persons will survive. If the body temperature is depressed to approximately 33°C, most persons will return to useful activity. At about 32°C, the level of consciousness becomes clouded and unconsciousness occurs at 30°C. Only 30 percent would be expected to survive these temperatures. At body temperature depressions of 26°C and below, the average individual will die, and ventricular fibrillation (heart attack) will usually occur as the final event. However in some cases individuals have survived with body temperatures as low as 17°C.
- 7.5.3 Hypothermia in a field environment can result from cold water immersion, exposure to cold wet conditions, or from a variety of medical conditions. As this is a life-threatening condition, the possibility of hypothermia will influence the time-frame for survival. As environmental conditions of rain, wind and snow worsen, the opportunity for body heat loss increases. This loss can be countered by insulation with clothing and/or insulation, both windproof and/or rainproof. As a rough guide, a person suffering from hypothermia when the temperature is 0°C may be expected to survive from as little as four hours up to ten or more days if they have the ability to find shelter and retain their body warmth.

7.6 Water Hypothermia

- 7.6.1 The body will cool when immersed in water having a temperature of less than 33°C. The warmest temperature that ocean water can be at any time of year is 29°C. Approximately one-third of the earth's oceans have water temperatures of 19°C or above. Most dams and inland waterways have water at temperatures far less than that of the ocean. Figure 7.1 illustrates the relationship between water temperature and immersion time.

- 7.6.2 The rate of body heat loss increases as the temperature of air and water decreases. If a survivor is immersed in water, hypothermia will occur very rapidly due to the decreased insulating quality of wet clothing and the fact that water will displace the layer of still air that normally surrounds the body. Water allows a rate of heat exchange approximately twenty five times greater than that of air at the same temperature.
- 7.6.3 In water temperatures above 21°C survival time depends solely upon the fatigue factor of the individual, with some individuals having survived in excess of 80 hours at these temperatures.
- 7.6.4 Between 15°C and 21°C an individual can survive up to 12 hours. At 15°C skin temperatures will decrease to near water temperature within 10 minutes of entry and shivering and discomfort is experienced immediately upon immersion. Dunking and submersion difficulties become increasingly distressful to the survivor.
- 7.6.5 From 10°C to 15°C the survivor has a reasonably good chance if rescue is completed within 6 hours. Faintness and disorientation occur at water temperatures of 10°C and below. Violent shivering and muscle cramps will be present almost from the time of entering the water and intense pain will be experienced in the hands and feet. This very painful experience will continue until numbness sets in.

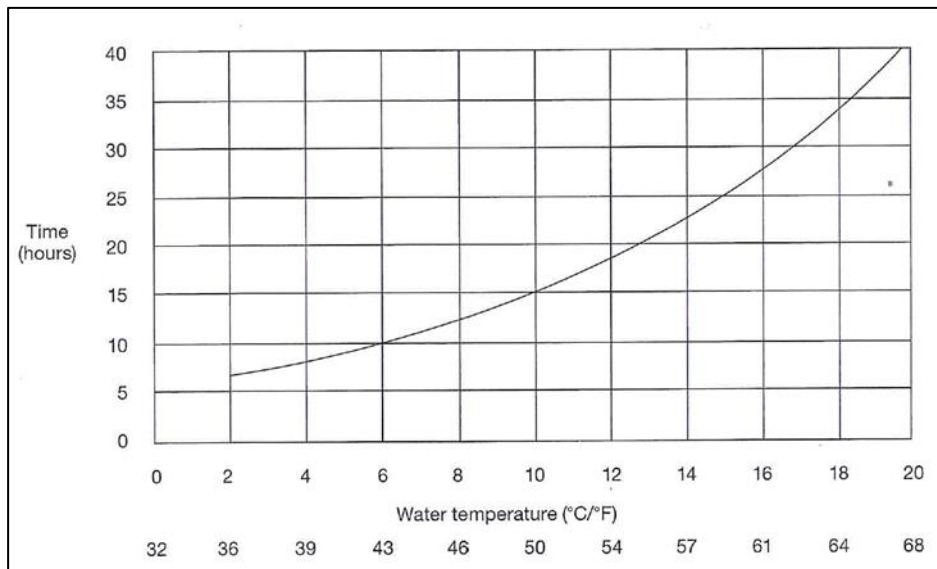

Figure 7-1 Realistic upper limit of survival time for people wearing normal clothing in water at various temperatures.

- 7.6.6 All skin temperatures decrease to that of the surrounding water temperature in about 10 minutes. In the temperature range from 4°C to 10°C, only about 50 per cent of a group can be expected to survive longer than 1 hour. In water temperatures of 2°C and below the survivor suffers a severe shock and intense pain on entering the water. This shock in some instances may be fatal owing to loss of consciousness and subsequent drowning.
- 7.6.7 Water survivors who die within 10 to 15 minutes after entry into frigid water apparently do not succumb because of reduced body temperature, but rather from the shock of rapid entry into cold water. Fifteen minutes is too short a time for the internal body temperature to fall to a fatal level, even though the outer skin temperatures are at the same temperature as the water. In addition, the temperatures of the hands and feet fall so rapidly that such immersions are frequently less painful than those in 4°C to 10°C water.

-
- 7.6.8 Factors that slow the loss of body heat are:
- a) High body weight;
 - b) Heavy clothing;
 - c) Survival clothing; or
 - d) The use of a huddling or other protective behaviour.
- 7.6.9 Factors that make a person lose body heat faster are:
- a) Age, (Young and elderly are more prone to hypothermia);
 - b) Low body weight;
 - c) Light clothing;
 - d) Exercising (such as the situation where a survivor without a lifejacket must swim to stay afloat); or
 - e) Seasickness.
- 7.6.10 Specialised insulated protective clothing, such as immersion suits or wet suits, is capable of increasing survival time from 2 to 10 times the basic duration shown on Figure 7.1.
- 7.6.11 Thus, in water at 5°C, the 50% survival time for a normally-clothed individual is estimated to be about one hour, with a recommended search time of six hours. The corresponding times for 10°C are two hours and 12 hours. While in water at 15°C the 50% survival time is about six hours, with the recommended search time of 18 hours. Between 20°C and 30°C search times exceeding 24 hours should be considered and searching for several days should be considered for water temperatures at the upper end of this temperature scale.
- 7.6.12 As there are many factors to consider, this model cannot be used for all situations. SOLAS survival suits are meant to keep a person alive for 24 hours in extremely cold water and a person may be able to keep himself out of the water by climbing onto wreckage, for example. It should be kept in mind that factors working positively on survival times are often unknown to the SMC. Some of these factors include, but are not limited to, the following:
- 7.6.13 Near-naked swimmers would be at the lower ranges of these times. In calm water there may be an exceptional individual (someone who is very fat and fit, for example) who will exceed expectations. If it is known that the victim is such an individual, consideration should, exceptionally, be given to extending the search times from 3-6 to 10 times the predicted 50% survival time.
- 7.6.14 For inshore incidents, survival times may be less because of breaking water and adverse currents. However, consideration must be given to the possibility that the inshore survivor managed to get ashore. Consequently, the limiting effects of cold water cooling will no longer be the only consideration and the search must be continued until the shore has been thoroughly searched.
- 7.6.15 For offshore incidents, it is reasonable to expect that individuals may be better equipped to survive and have access to appropriate protective clothing, such as lifejackets and possible life rafts. Consequently, search times for them should be at the upper limits of those expected (10 times predicted 50% survival time), unless obviously adverse conditions prevail, and should exceed them if it is possible that survivors may have been able to get out of the water.
- 7.6.16 Survival time is shortened by physical activity (such as swimming) and increased by wearing heavy clothing and, if wearing a lifejacket, adopting protective behaviours (such as huddling with other survivors or adopting a foetal position in the water). Specialised insulated protective clothing (such as immersion suits or wet suits) is capable of increasing survival time from two to 10 times. The SMC should bear in mind that ingress of as little as half a litre of water into an immersion/survival suit can reduce its insulation value by 30% and that wave height of one metre can reduce it by an additional 15%.
- 7.6.17 Predicting survival times for immersion victims is not a precise science; there is no formula to determine exactly how long someone will survive or how long a search should continue. The SMC must make some difficult decisions based on the best information available and a number

of assumptions and should extend the search time beyond that which they can reasonably expect anyone to survive.

Estimated wind speed (knots)	Actual air temperature (°C/F)					
	10/50	0/32	-12/10	-23/0.9	-35/-31	-45/-49
0	Little danger for properly dressed persons			Increased danger of freezing of exposed flesh		Great danger of freezing of exposed flesh
10						
20	Little danger for properly dressed persons			Increased danger of freezing of exposed flesh		Great danger of freezing of exposed flesh
30						
40 or more	Little danger for properly dressed persons			Increased danger of freezing of exposed flesh		Great danger of freezing of exposed flesh

Figure 7-2 Wind Chill and Hypothermia

7.7 Wind Hypothermia

- 7.7.1 Although the body will lose heat approximately twenty-five times slower in calm air than when immersed in water, the body heat loss will be accelerated with increasing wind velocities. This is an additional factor to consider for exposed survivors.
- 7.7.2 Hypothermia can occur on land as well as at sea. A human has a much greater chance of suffering hypothermia if immersed in the sea or other waterway. The warmest sea water will generally get is about 29°C, with a worldwide average of 19°C. Temperature loss in water is about 25 times greater than in air of the same temperature. Therefore, immersion in the sea can drop body core temperatures very quickly.
- 7.7.3 Hypothermia can happen during cold nights in desert country or anytime in the colder areas of Australia. It occurs when the body's core temperature falls below 35°C. It is characterised by intense shivering, followed by loss of co-ordination, confusion and irrationality. If it is not halted unconsciousness will follow and then ultimately death. This can happen in a period as short as one hour. Once the body's core temperature falls to 28°C the heart will stop. If a person is wet, ill or dehydrated it will lessen their chances of fighting off hypothermia. Symptoms are shivering, poor co-ordination, and decreasing levels of consciousness, slow and irregular pulse and numbness. This is a medical emergency. To treat, remove from the cold, remove any wet clothing, move to a warm area if possible. Cover the victim with blankets and apply hot water bottles or pads. Remember that the victim has lost body heat and will not be able to warm themselves so just covering them with a blanket will not do, you have to provide a source of warmth. Warm slowly. Seek urgent medical attention. Do not allow the victim to relax as the sudden rush of cold blood from the extremities can cause the heart to stop. This has happened during previous SAR missions when the victim has been located, relaxed and has gone into cardiac arrest.

7.8 Wind Chill

- 7.8.1 This is the sensation of cold felt by humans as a result of wind movement. This causes people to feel colder than the actual temperature, even in low wind conditions. The wind-chill diagram below is an adaptation of the work of Steadman and Dixon where the wind speed has been converted from metres per second to kilometres per hour, rounded up or down to the nearest 5 km.

Wind Chill Chart											
Air Temp C°	5	0	-5	-10	-15	-20	-25	-30	-35	-40	-45
Wind Speed kph											
5	4	-2	-7	-13	-19	-24	-30	-36	-41	-47	-53
10	3	-3	-9	-15	-21	-27	-33	-39	-45	-51	-57
15	2	-4	-11	-17	-23	-29	-35	-41	-48	-54	-60
20	1	-5	-12	-18	-24	-30	-37	-43	-49	-56	-62
25	1	-6	-12	-19	-25	-32	-38	-44	-51	-57	-64
30	0	-6	-13	-20	-26	-33	-39	-46	-52	-59	-65
35	0	-7	-14	-20	-27	-33	-40	-47	-53	-60	-66
40	-1	-7	-14	-21	-27	-34	-41	-48	-54	-61	-68
45	-1	-8	-15	-21	-28	-35	-42	-48	-55	-62	-69
50	-1	-8	-15	-22	-29	-35	-42	-49	-56	-63	-69
55	-2	-8	-15	-22	-29	-36	-43	-50	-57	-63	-70
60	-2	-9	-16	-23	-30	-36	-43	-50	-57	-64	-71
65	-2	-9	-16	-23	-30	-37	-44	-51	-58	-65	-72
70	-2	-9	-16	-23	-30	-37	-44	-51	-58	-65	-72
75	-3	-10	-17	-24	-31	-38	-45	-52	-59	-66	-73
80	-3	-10	-17	-24	-31	-38	-45	-52	-60	-67	-74

Figure 7-3 Wind Chill Table

- 7.8.2 The above graph, figure 7-3, replaces the older axionomic diagram and makes determining wind chill easier. An air temperature is -20°C and a wind speed of approximately 30 km/h produces an equivalent wind chill temperature of approximately -33°C on exposed flesh. The green areas will not pose much threat to exposed flesh for short periods and can be tolerated by most healthy people. Yellow areas are temperatures that pose an increase in frostbite risk for exposures over 10 to 30 minutes. The orange areas will pose a frostbite threat in 5 to 10 minutes. Pink is a high risk of frostbite between 2 to 5 minutes and red is a very high risk for exposures of more than 2 minutes.

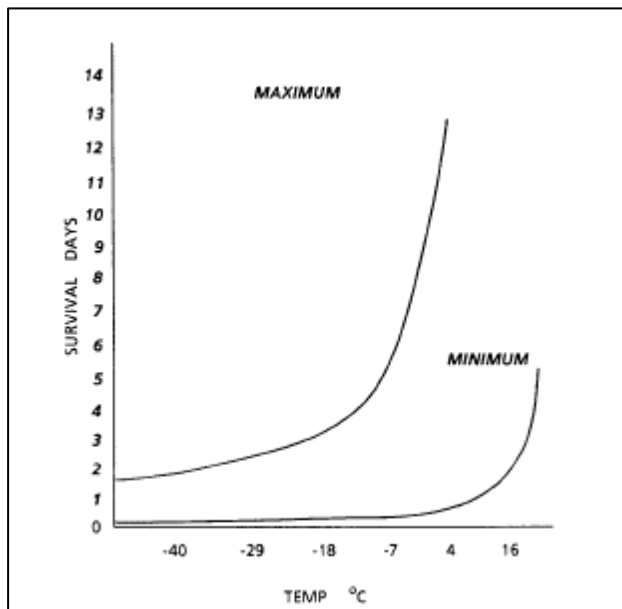

Figure 7-4 Hypothermia Survivability Graph

7.9 Hypothermia Survivability

- 7.9.1 The above graph which describes the range of days for fatal exposure or hypothermia survivability, for a given temperature. The information calculated is a guide only and is based upon a healthy 25 year old male wearing the equivalent of normal clothing, including a jacket, and is also based on a survivor not undertaking any strenuous activities.
- 7.9.2 The temperature on the bottom line is the ambient air temperature corrected for wind chill using Table 7-2 to make the conversion. The scale on the left represents survival time in days.
- 7.9.3 This graph is relatively old and does not take into account any environmental or survivability factors. Any activities that increase the rate of perspiration or body fluid loss may initially warm that person up but will contribute to wet chill and will ultimately shorten the time frames provided by this graph.

7.10 Wet-Chill Survivability

- 7.10.1 The below graph, Figure 7-5, describes wet-chill survivability. Accidental hypothermia resulting from wet-chill is the most dangerous and commonly-fatal weather hazard. Essentially, wet-chill is the wetting of the missing person in cold and windy weather and the subsequent increased cooling down resulting from the evaporation of the moisture.

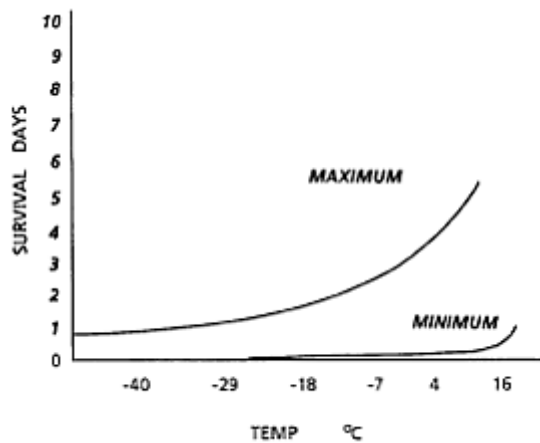

Figure 7-5 Wet Chill Survivability Graph

- 7.10.2 The result is a significant decrease in that person's ability to survive unless they can find or made heat and/or shelter.
- 7.10.3 The temperature on the bottom line is the ambient air temperature corrected for wind chill. The scale on the left represents survival time in days.
- 7.10.4 This graph is relatively old and does not take into account any environmental or survivability factors of the missing person.

7.11 Water Immersion

- 7.11.1 Hypothermia induced by immersion in cold water has a more rapid onset. There is no ready answer to how long a person will survive as there are many factors involved including:
- Water temperature;
 - Duration of immersion;
 - Insulation (body fat and clothing worn);
 - Level of activity; and
 - Weather conditions (especially wind and wave action).
- 7.11.2 The following chart is a guide to the survival time of a lean person in rough water and should not be regarded as arbitrary. For this reason, searchers must treat cold water areas such as streams, lakes and dams as significant danger to the missing person(s).

Clothing Type	Time to Incapacity (Body Core Temp 34°C)	Time to Unconsciousness (Body Core Temp 30°C)	Time to Cardiac Arrest (Body Core Temp 25°C)
Light Clothing	0.4 Hrs	0.8 Hrs	1.3 Hrs
4.8 mm Wet Suit	1.6 Hrs	3.2 Hrs	4.9 Hrs
Insulated Dry Clothing	3.0 Hrs	5.7 Hrs	9.1 Hrs

Table 7-1 Water Immersion Table Based on Steinman and Kublis (1986)

Note: The above times are not cumulative and are a guide only. An example of the variation in survival time between two persons in light clothing immersed in water at 6°C is that one could remain capacitated for 1.3 hours whilst the second could go into cardiac arrest in the same time.

7.12 Effects of Alcohol

- 7.12.1 The consumption of alcohol can impact upon the time-frame for survival, both in hot and cold environments. Alcohol is likely to accelerate dehydration in hot climate and may lessen the ability to retain heat in cold areas.
- 7.12.2 In cold weather alcohol has the tendency to vaso-dilate the smaller blood vessels, allowing warm core blood to flow to the extremities, providing a feeling of warmth. In reality it has the effect of allowing warm blood to come into contact with cold air, cooling it down and resulting in lowering the core body temperature, increasing the effects of hypothermia.
- 7.12.3 In warmer climates the physiological process is the same, this time allowing cooler core blood to heat up in the extremities, resulting in an increase in core body temperature, hastening the effects of hyperthermia.

7.13 Hyperthermia, Heat Stress and Dehydration

- 7.13.1 Hyperthermia, heat stress and dehydration are dangers in hot climates, particularly in desert areas. The most severe form of heat stress is heatstroke, during which the body temperature rises due to the collapse of the temperature control mechanism of the body. If the body temperature rises above 42°C, the average person will die. Milder forms of heat stress are heat cramps and heat exhaustion. Another limiting factor both in hot climates and in survival situations at sea is dehydration. A person totally without water can die within a few hours (Western Qld 1999 4 hrs from leaving vehicle to death), although some have survived for a week or more in environments where moisture loss was at a minimum.

-
- 7.13.2 Dehydration is the excessive loss of water from the body, this leads to an imbalance in the electrolytes. As the body is composed mostly of water there needs to be equilibrium between water lost, as in sweat and urine, and water gained as in drinking and food. If more water is lost than ingested then dehydration is the result. Severe dehydration can end in death. Small amounts of water or clear fluids can assist a person suffering dehydration but ultimately medical attention needs to be sought as fluids can be replaced more efficiently intravenously. The body can only take in approximately 1.1 litres of liquid per hour via the stomach whereas intravenous fluids can be introduced at a much greater rate if necessary.
- 7.13.3 The human body functions best at $38^{\circ}\text{C} \pm 2^{\circ}\text{C}$, although it will tolerate the core temperature dropping to 33°C or rising to 42°C with a good chance of full recovery. Between 32°C and 26°C body functions begin to shut down and unconsciousness usually follows. Below 26°C the average individual will perish, although there have been many cases of persons surviving. Temperatures above 43°C will prove fatal in most circumstances unless urgent medical assistance is sought. Death can occur in as short a period as four hours.
- 7.13.4 The least serious, but still potentially dangerous, of the heat related problems are muscular cramps. The exact cause is unknown but the onset of cramps can be rapid. They mostly affect the larger muscles of the body, but can occur in any of the body's muscles. Cramping is brought on by strenuous activity in warm or moderate temperature conditions and can be described as a bunching or shortening of the muscles causing what feels like a knot. To alleviate cramps place the victim in a cool, comfortable place, provide cool water but do not give salt or salt tablets as a normal diet contains adequate salt for recovery. The cramped muscles may be lightly stretched and massaged to hasten recovery. Recovery is normally swift.

7.14 Heat Exhaustion

- 7.14.1 This is the next most serious of the heat related illnesses. It is brought on by long periods of activity in a hot environment. This not only occurs with persons in arid areas but also to fire-fighter and factory workers working in confined spaces with high temperatures.
- 7.14.2 To maintain a constant body temperature in hot weather the body sweats, using the evaporation of body fluids from the skin to produce a cooling effect. A side effect of this is the loss of vital body fluids which in turn decreases blood volume. Blood temperature then rises resulting in an increased blood flow to the limbs to assist in cooling, reducing blood flow to the internal organs. This lack of blood can cause shock and heat exhaustion. If recognised early heat exhaustion can often be controlled and reversed. If left undetected the body's temperature will continue to rise and will result in changes in levels of consciousness. Symptoms include dizziness and weakness, exhaustion, rapid and weak pulse, nausea, headache, skin that may feel cool and moist and look pale but progressing to hot and red.
- 7.14.3 First aid treatment of heat exhaustion is vital. If conscious lay the victim down in a cool and shaded area with legs slightly elevated, remove or loosen tight clothing, give water in small quantities. If vomiting or unable to drink seek urgent medical attention. If the victim is unconscious place them in the recovery position in a cool and shaded area. Check breathing, airway and circulation. Keep them cool and seek urgent medical attention. Lowering core body temperature via a wet sheet fanned to produce a cooling effect through evaporation is very effective.
- 7.14.4 Danger considerations when conducting search operations in hot and humid conditions. The areas identified in RED and BLACK are considered extremely dangerous for searchers (refer to figure below).

Wet Bulb Globe Temperature (WBGT) from Temperature and Relative Humidity																	
Temperature in Degrees Celsius																	
		20	22	24	26	28	30	32	34	36	38	40	42	44	46	48	50
Relative Humidity (%)	0	14.8	16.1	18	18.6	19.8	21.2	22.3	23.5	24.7	25.8	27	28.1	29.3	30	31.4	32.5
	5	15.3	16.7	18.7	19.4	20.7	22	23.3	24.6	25.9	27.2	28.4	29.6	30.9	32.3	33.4	34.6
	10	16	17.4	19.4	20.2	21.6	23	24.3	25.7	27.1	28.4	29.7	31.1	32.4	33.8	35.1	36.4
	15	16.5	18	20.1	20.9	22.4	23.8	25.2	26.7	28.1	29.6	31	32.4	33.8	35.2	36.7	38.1
	20	17.1	18.7	20.8	21.6	23.1	24.6	26.2	27.7	29.2	30.6	32.1	33.6	35.1	36.6	38.2	39.7
	25	17.6	19.3	21.4	22.3	24	25.5	27	28.6	30.1	31.7	33.2	34.8	36.3	37.9	39.5	
	30	18.2	19.8	22	23	24.6	26.2	27.8	29.4	31	32.7	34.2	35.9	37.4	39.1		
	35	18.7	20.3	22.6	23.6	25.3	26.9	28.6	30.2	31.9	33.5	35.2	36.8	38.5			
	40	19.3	20.9	23.2	24.3	26	27.6	29.4	31	32.7	34.4	36.1	37.8	39.5			
	45	19.7	21.5	23.8	24.9	26.6	28.3	30.1	31.8	33.5	35.2	37	38.7				
	50	20.2	22	24.3	25.5	27.3	29	30.8	32.5	34.3	36.1	37.9	39.6				
	55	20.7	22.4	24.8	26	27.8	29.6	31.4	33.3	35	36.8	38.6					
	60	21.1	22.9	25.4	26.6	28.4	30.2	32.1	34	35.7	37.5	39.4					
	65	21.6	23.2	25.9	27.1	29	30.9	32.5	34.4	36.3	38.2						
	70	22.1	23.9	26.4	27.6	29.4	31.4	33.3	35.1	37	38.9						
	75	22.5	24.4	26.9	28.2	30.1	32	33.8	35.8	37.7	39.5						
	80	22.9	24.8	27.4	28.7	30.6	32.5	34.4	36.3	38.2							
85	23.3	25.2	27.8	29.2	31.1	33	35	36.9	38.9								
90	23.7	25.7	28.3	29.6	31.6	33.5	35.5	37.5	39.5								
95	24.2	26.1	28.7	30.1	32	34	36	38	40								
100	24.5	26.5	29.1	30.5	32.5	34.5	36.5	38.5									

Note: This chart is calculated using temperature and humidity, assuming a very clear sky (Maximum solar load), and atmospheric pressure of 1 ATA (760 mmHg) This chart was developed by Professor Yoram Epstein. It was to be used with Areil's Checklist for hikers in Israel but has relevance to Australian Arid environments.

CAUTION	EXTREME CAUTION	DANGER	EXTREME DANGER
Fatigue possible	Muscle cramps, Heat exhaustion, Heat stroke possible	Heat exhaustion, Heat stroke likely	Heat stroke, collapse, death possible

Figure 6: Wet Bulb Globe Temperature (WBGT) from Temperature and Relative Humidity Temperature in Degrees Celsius

7.15 Heat Stroke

7.15.1 This is the most serious of the heat related illnesses. As the body's fluid levels become low sweating stops. As a result of this the body's core temperature continues to rise. The lack of blood to the vital organs necessitates that blood be brought from the limbs back to the core, thereby contributing to a further increase in body temperature. At this stage the body is unable to cool itself and the temperature rises rapidly. Vital organs then begin to fail; convulsions, unconsciousness and death soon result. Symptoms of heat stroke include rapid, shallow breathing, a pulse that may be strong and rapid at first but deteriorating to weak and irregular, falling in and out of consciousness, hot, dry and red skin and a high body temperature. Immediately seek urgent medical assistance. Treatment is similar to heat exhaustion. Stop the victim from doing anything; at this stage they will have lost the ability to make rational decisions.

Place them in a cool area, lying down with the legs elevated. Cool the body and given small quantities of cool water. Seek urgent medical assistance. To cool the body remove any tight or restrictive clothing and any clothing soaked with perspiration. Cover the skin with cool and wet items such as towels. Fan the body to aid in evaporation and cooling. Continue to do so until the body's temperature falls to 38°C.

- 7.15.2 In all cases rapid assessment of the situation and prompt first aid can mean the difference between life and death. If you have any doubt about which stage a victim may be in then assume the worst and treat accordingly.

7.16 Hyperthermia Survivability

- 7.16.1 The below graphs, Figures 7-4 and 7-5, provide a guide to expected desert survivability but should not be regarded as arbitrary. The old survival adage of three (3) minutes without air, 3 days without water and 3 weeks without food should be remembered when referring to these graphs.

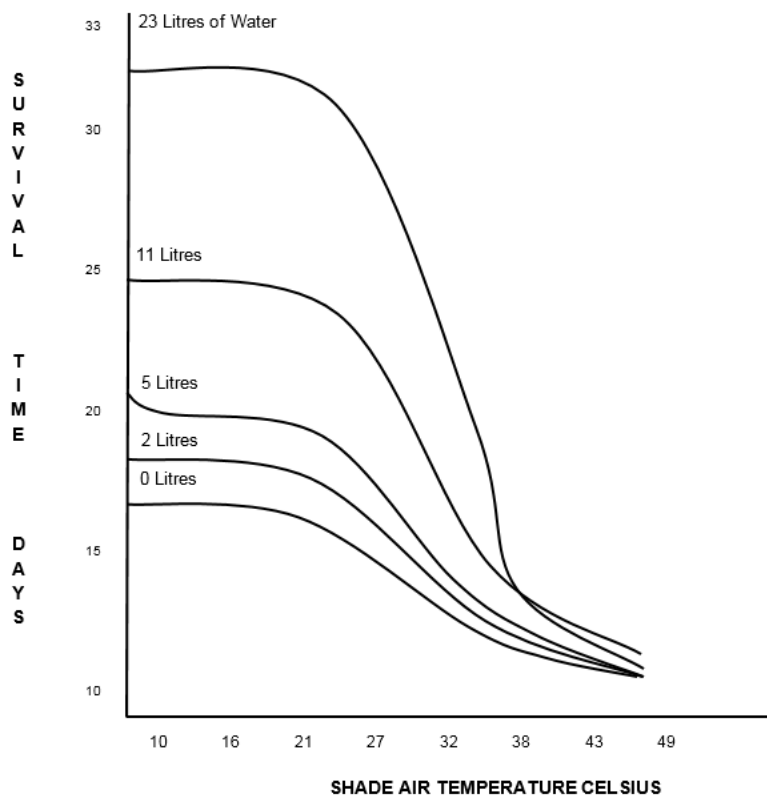

Figure 7-8 Approximate Desert Survival (Survivor Stationary)

- 7.16.2 The shade air temperature on the bottom line of both graphs represents the temperature as measured by a thermometer out of direct sunlight, such as you would find in a Stevenson Screen.
- 7.16.3 The survival time on the left side is measured in days, while the curved lines represent the amount of water, in litres, available.
- 7.16.4 Figure 7-4 provides the time frames for a missing person whom is stationary, either in a vehicle, shelter or other location not directly exposed to the sun.
- 7.16.5 Figure 7-5 provides a similar time frame for a person attempting self-help, walking at night time.
- 7.16.6 Any activity undertaken that would cause loss of body fluids through excessive sweating or urination will significantly reduce the potential time frame for survival. Survival manuals often suggest constructing solar stills or other means of water production in these situations. Doing so

will often expend far more fluids than can be collected, particularly within the Australian outback where most plants have adapted strategies to reduce moisture loss.

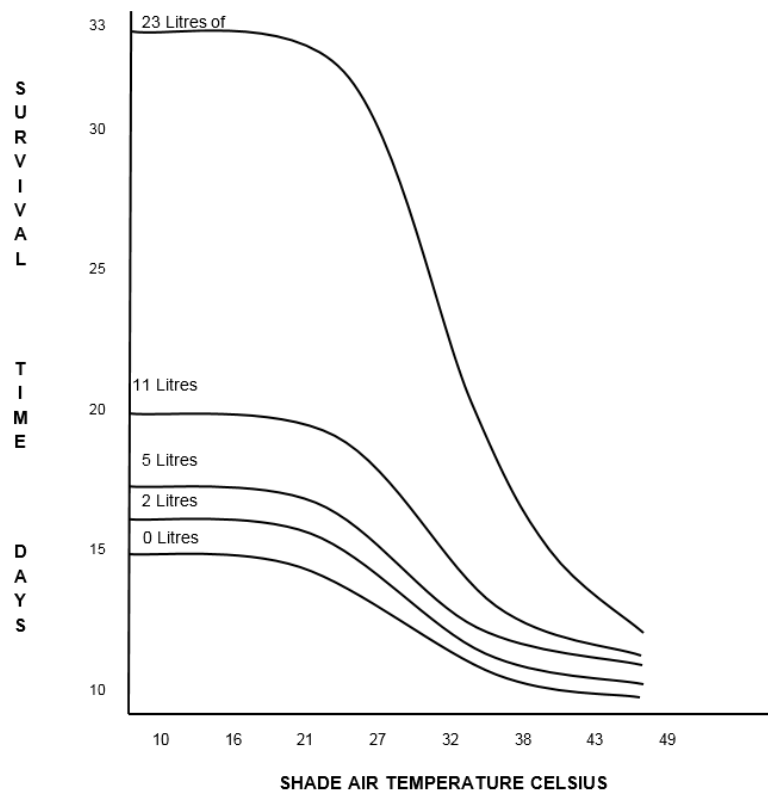
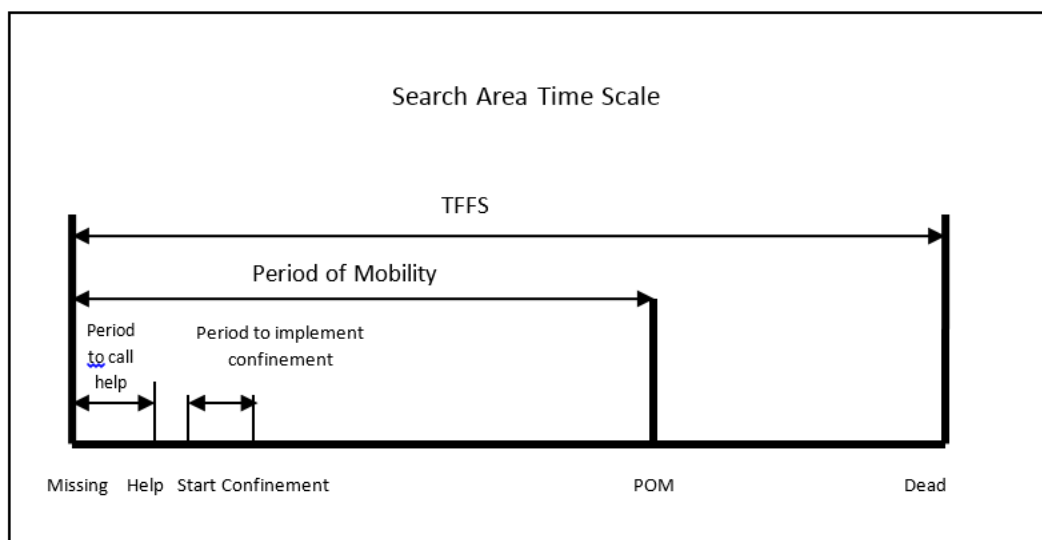

Figure 7-9 Desert Survival (Survivor night walking)

- 7.16.7 Dehydration: The rate of dehydration will vary with the temperature, movement of the missing person, their medical condition and other factors. As a guide, a person missing and who has access to only 2 litres of water may be expected to survive from as little as a few hours in extremely hot climates, to as much as 20 or more days in temperate climate. It should be remembered that alcohol is not a substitute for water and may accelerate dehydration.
- 7.16.8 Period of Mobility (POM): The period of mobility or time to confinement since missing are used to assess the maximum distance a missing person could travel which will, in turn, dictate the size of the overall search area. An assessment of the period of mobility can be made by assuming a mobility period of 2/3 or 67% the missing person's time frame for survival.
- 7.16.9 Search Area Time Scale: The total search area time-scale may be plotted to give a clear picture of the situation and the time by which the missing person should be found, to ensure the greatest chance of survival.



7.16.10

Figure 7-10 Search Area Time Scale

- 7.16.11 Example: A person is missing in the alpine area of NSW. The wind is 40kph from the south. Air temperature is 0°C degrees and they are wearing nothing but underclothes. Using the wind chill table (Table 7-3) we can ascertain that the equivalent air temperature is going to be very cold, about -7°C. Consultation with the hypothermia graph (Figure 7-2) will give an approximate period of survival of between ¼ day (6hrs) and 4 ½ days. If our missing person can find shelter and warmth they may survive to the 4 ½ day period. If they remain out in the open with limited clothing they will possibly perish within the 6 hours. It now starts to rain, soaking our MP. Consulting the Wet Chill Survival graph (Figure 7-3) we can see that there will be a distinct shortening of the TFFS. It is now between about 4 hours and 2 days, depending on what the MP is able to find by way of shelter and warmth. The POM can be as short as 2 ½ hours to just over a day. There is a definite amount of urgency required now. The desert survival charts can be read in a similar way, but be aware these were developed for the northern hemisphere. There are a number of recorded instances where persons have perished in the deserts of Australia in as little as four hours without water.
- 7.16.12 Starvation: If a person is recovered alive and they have been without food and water for a significant period of time be aware that there are pitfalls to offering them food and/or water even though they may request it. Advice is to initially provide them with UHT (Long Life) milk and dried meat similar to biltong or jerky. Both of these are easily digested and do not generally cause problems if given in small doses. If in doubt always seek medical advice.

7.17 Terrain Factors

- 7.17.1 Terrain may be a major factor in evaluating an incident. Terrain may dictate the type of search pattern required, and may limit the selection of search aircraft that can be used. Aircraft that are highly manoeuvrable and will be effective at moderately high altitudes may be required in rugged mountain areas. High performance or large transport aircraft may be unusable in confined areas and helicopters may not be able to operate in the thin air and turbulence associated with mountains and contour searches.
- 7.17.2 Terrain may also limit the time available for search. For example low-level searches in mountain areas are normally limited to daylight only. The type of survival kit carried by the distressed target and the equipment, such as the type of hoist device used by available helicopters will also be influencing factors. Dense foliage may hamper both visual and electronic searches and require increased numbers of aircraft and closer search track spacing.
- 7.17.3 Man-made additions to the terrain such as power-lines, towers and bridges must also be considered when planning search areas and the altitudes of search aircraft.

- 7.17.4 The type of rescue team used after the distress site has been located is also dependent upon terrain. When there is doubt about survivors or the area is inaccessible, time is a factor. Should other help not be readily available, airdrops or parachutists may be required. Before deploying parachutists, the ability for them to land, to be resupplied and recovered must be considered.

7.18 Seeking Medical Advice

- 7.18.1 The following mnemonic (INSPECTOR) has been developed to assist SMC's in ensuring that they have sufficient information for a considered medical opinion to be given:

I	Incident details as they pertain to the medical factors
N	Name of the missing person/s
S	Scenario, back ground information to assist in determining the TFFS. (Why or how is the person/s lost, overdue, accidents, falls, situational awareness)
P	Physical/Medical/Behavioural characteristics of the missing person/s (Including physical impairments or abilities, medical issues, disease, health conditions, medication taken and do they have it, despondency, paranoia, mental issues)
E	Experience/ability in the situation they are currently in, past incidents they have survived, traumatic events, work history that may be relevant
C	Clothing/equipment worn or carried
T	Terrain/sea conditions; vegetation, topography, wave heights, swell, distance from assistance
O	Oral; Water and food carried, availability, ability to find food and water
R	Rain/weather; before the incident, at the time of the incident and predicted weather for following days

Appendices

NATIONAL SEARCH AND RESCUE MANUAL

2023 EDITION Version 1 – February 2023

Appendix A – Intergovernmental Agreement

This appendix contains a copy of the 2017 IGA applicable to the Australian National SAR Plan.



Australian Government
Australian Maritime Safety Authority

INTER-GOVERNMENTAL AGREEMENT ON NATIONAL SEARCH AND RESCUE RESPONSE ARRANGEMENTS

INTER-GOVERNMENTAL AGREEMENT ON NATIONAL SEARCH AND RESCUE RESPONSE ARRANGEMENTS

This AGREEMENT is made in November 2017.

BETWEEN

THE COMMONWEALTH OF AUSTRALIA

THE STATE OF NEW SOUTH WALES

THE STATE OF VICTORIA

THE STATE OF QUEENSLAND

THE STATE OF WESTERN AUSTRALIA

THE STATE OF SOUTH AUSTRALIA

THE STATE OF TASMANIA

THE NORTHERN TERRITORY OF AUSTRALIA

THE AUSTRALIAN CAPITAL TERRITORY

(‘The Parties’)

1. DEFINITIONS

- 1.1 **‘Alerting Post’** means any facility serving as an intermediary receiving distress alerts and then responsible for onward distribution to the responsible SAR Authority.
- 1.2 **‘AMSA’** means the Australian Maritime Safety Authority.
- 1.3 **‘Australian SAR Authority’** means the authority with international responsibility for compliance with Australia’s search and rescue obligations, being AMSA.
- 1.4 **‘International distress alert’** means an internationally recognised distress alert or signal with location data, if available.
- 1.5 **‘National Search and Rescue Response Arrangements’** means this agreement.
- 1.6 **‘National SAR Council’** means the National Search and Rescue Council as constituted in accordance with paragraph 3.1 of this agreement.
- 1.7 **‘National SAR Manual’** means the National Search and Rescue Manual endorsed by the National SAR Council as the standard reference to be used by all search and rescue authorities in Australia for search and rescue operations.
- 1.8 **‘SAR’** means search and rescue.

2

- 1.9 **'SAR Facility'** means any mobile resource, including designated search and rescue units, used to conduct search and rescue operations.
- 1.10 **'State and Territory SAR Authorities'** means the following agencies nominated by each Party to this agreement:
- The New South Wales Police for the State of New South Wales;
 - The Victoria Police for the State of Victoria;
 - The Queensland Police for the State of Queensland;
 - The Western Australia Police for the State of Western Australia;
 - The South Australia Police for the State of South Australia;
 - The Tasmania Police for the State of Tasmania;
 - The Northern Territory Police for the Northern Territory;
 - The Australian Federal Police for the Australian Capital Territory including Jervis Bay; and
 - The Australian Federal Police for the territories of Christmas Island, Cocos (Keeling) Islands, and Norfolk Island.
- 1.11 **'State/Territory Emergency Service Agencies'** means the agencies that have responsibility for providing State/Territory emergency services as legislated within each State/Territory, which provide support to the national SAR arrangements.
- 1.12 **'Vessels'** and **'craft'** do not include vessels and craft of the Australian Defence Force or those of the defence force of any other country.

2. PURPOSE OF THE AGREEMENT

- 2.1 This agreement is intended to provide guidance to the SAR Authorities of all Parties, recognising that:
- 2.1.1 This Agreement updates and replaces the Agreement signed 29 June 2012;
- 2.1.2 AMSA, established under the Australian Maritime Safety Authority Act 1990 as a Commonwealth statutory authority, has as a legislative function the provision of a national search and rescue service in a manner consistent with Australia's obligations under the:
- *Convention on International Civil Aviation, 1944* ('Chicago' Convention);
 - *International Convention for the Safety of Life at Sea, 1974* (SOLAS) (the Safety Convention); and
 - *International Convention on Maritime Search and Rescue, 1979* (the SAR Convention);
- 2.1.3 The promotion of continued cooperation in the provision of search and rescue between the Australian SAR Authority and each of the State and Territory SAR Authorities is essential; and

- C. The Parties accept the administrative and funding arrangements underpinning the operation of the National Search and Rescue Response Arrangement as outlined in this agreement.
- D. The Parties agree to support the National Search and Rescue Arrangement to ensure that:
- (i) Australia's obligations under international conventions and agreements relating to search and rescue are fulfilled;
 - (ii) The national approach to search and rescue coordination is continued and strengthened;
 - (iii) The National SAR Manual is formally recognised as the standard reference for use by the Australian and the State and Territory SAR Authorities;
 - (iv) Parties are clear about their responsibility for planning for and resourcing search and rescue operations involving persons, vehicles, vessels and aircraft on land and at sea, in accordance with the National SAR Manual;
 - (v) Mechanisms are in place to facilitate cooperative decision making; and
 - (vi) The obligations of Parties under this arrangement are met.
- E. The Parties agree that this agreement updates and replaces the Agreement signed 30 June 2004.
- F. The Parties note that AMSA, established under the *Australian Maritime Safety Authority Act 1990* as a Commonwealth statutory authority, has as a legislative function the provision of a national search and rescue service in a manner consistent with Australia's obligations under the:
- *Convention on International Civil Aviation, 1944* (Chicago Convention);
 - *International Convention for the Safety of Life at Sea, 1974* (SOLAS); and
 - *International Convention on Maritime Search and Rescue, 1979* (the SAR Convention).

Accordingly, AMSA will act as Secretariat for the National SAR Council and will facilitate the implementation of this agreement.

- 2.1.4 The National Search and Rescue Response Arrangements for coordination of resources to be used in search and rescue operations are fundamental to the success of a national search and rescue service.

3 TERMS OF THE AGREEMENT

- 3.1 The Parties agree that the National SAR Council will be the national coordinating body for search and rescue response arrangements in Australia, with the following functions:
- I. oversee the implementation of search and rescue arrangements within Australia's search and rescue region for consistency with the National Search and Rescue Response Arrangements;
 - II. sponsor and promote the development and use of the National SAR Manual, which details agreed search and rescue response and coordination arrangements in Australia; and
 - III. promote the ongoing effectiveness of the cooperative arrangements between the SAR Authorities.
- 3.2 The Parties will take such action as is provided for by this agreement and as is otherwise required to achieve the objectives of the National Search and Rescue Response Arrangements in accordance with the roles and responsibilities set out below.
- 3.3 The Parties accept the administrative and funding arrangements underpinning the operation of the National Search and Rescue Response Arrangement as outlined in this agreement.
- 3.4 The Parties will plan and resource for search and rescue responsibilities as set out in the National SAR Manual, recognising and accepting that the first SAR Authority to become aware of a search and rescue incident is obliged to respond until overall coordination can be transferred to the SAR Authority best placed to coordinate the response, in accordance with the principles set out in the National SAR Manual.
- 3.5 The Parties agree to support the National Search and Rescue Arrangement to ensure that:
- I. Australia's obligations under international conventions and agreements relating to search and rescue are fulfilled;
 - II. The national approach to search and rescue coordination is continued and strengthened;
 - III. Mechanisms are in place to facilitate cooperative decision making; and
 - IV. The obligations of Parties under this arrangement are met.

4 RESPONSIBILITIES FOR SEARCH AND RESCUE

- 4.1 The Parties agree to continue to recognise and maintain the long standing and well understood division of responsibility between the Commonwealth and the States and Territories for search and rescue in relation to persons, vessels, vehicles and aircraft.

4.2 The Australian SAR Authority

- 4.2.1 The Australian SAR Authority will have primary responsibility for coordinating search and rescue operations for:
- I. International civil aircraft, manned space vehicles and aircraft on the Civil Aviation Safety Authority (CASA) and Recreational Aviation Australia (RA-Aus) registers; and
 - II. Persons on or from a vessel at sea.
- 4.2.2 The Australian SAR Authority has a function as an Alerting Post responsible for receiving international distress alerts for onward distribution to the responsible SAR Authority as per appendix B of the NATSAR Manual.
- 4.2.3 The Australian SAR Authority will be responsible for any liaison with international search and rescue authorities that may be required in response to any search and rescue operation.
- 4.2.4 The Australian SAR Authority will be responsible for the overall coordination of any national emergency plan or arrangement involving search and rescue within the Australian search and rescue region.

4.3 State and Territory SAR Authorities

- 4.3.1 The State and Territory SAR Authorities will have responsibility for coordinating search and rescue operations for:
- I. Persons and vehicles on land;
 - II. Persons and vessels on inland waterways and in waters within the limits of the ports of the relevant State or Territory;
 - III. Persons on or from a vessel at sea;
 - IV. Aircraft not included in the CASA and RA-Aus registers including ultralights, paragliders, hang-gliders, and gyrocopters; and
 - V. Land searches for missing registered civil aircraft in support of the Australian SAR Authority.
- 4.3.2 The State and Territory SAR Authorities will coordinate volunteer rescue organisations within their respective jurisdictions.

5 COOPERATIVE ARRANGEMENTS

- 5.1 The Parties agree to the following cooperative arrangements to underpin Australia's search and rescue system:
- I. The National SAR Manual is formally recognised as the standard reference for operational use by the Australian and the State and Territory SAR Authorities.
 - II. The Australian and State and Territory SAR Authorities are to follow the cooperative arrangements described in the National SAR Manual.

- III. The SAR Authority first becoming aware of a search and rescue incident will take all necessary action until responsibility can be handed over to the search and rescue authority better placed to take overall coordination.
- IV. When a number of SAR Authorities contribute to a search and rescue operation, one SAR Authority will have overall coordination responsibility and the others will act in support in accordance with the procedures established by the National SAR Manual.
- V. If an aviation or maritime search and rescue operation for which a State or Territory SAR Authority has overall coordination over-reaches that Authority's capabilities overall coordination may, by mutual consent, be transferred to the Australian SAR Authority in accordance with the procedures established by the National SAR Manual. Similarly, if the Australian SAR Authority is over committed with other search and rescue operations it may, by mutual consent, transfer overall coordination to a State or Territory SAR Authority. No SAR Authority will unreasonably refuse the transfer of overall coordination.
- VI. The Parties agree to ensure that any emergency management plan or arrangement that impacts on search and rescue preparedness and/or response, is considered by the National SAR Council to ensure that the appropriate coordination and harmonisation is in place.
- VII. The Parties will facilitate the involvement of State/Territory Emergency Service Agencies and other organisations within their respective areas of responsibility, to provide support to the national SAR arrangements.

6 SAR RESOURCING AND OPERATIONAL EXPENSES

- 6.1 Each Party shall provide resources to its SAR Authority based on planning for search and rescue responses as outlined above.
- 6.2 The Australian and the State and Territory SAR Authorities shall each provide, without charge unless otherwise agreed, such assistance or facilities as may reasonably be requested by the SAR Authority with overall coordination of a search and rescue operation.
- 6.3 The Australian and the State and Territory SAR Authorities will each coordinate the provision of assistance or facilities by the State/Territory Emergency Service Agencies and other organisations that support the national SAR arrangements within their respective jurisdictions, without charge unless otherwise agreed, as may reasonably be requested by the SAR Authority with overall coordination of a search and rescue operation.
- 6.4 A SAR Authority that hires or requisitions privately owned facilities for a search and rescue operation will, unless otherwise agreed between the SAR Authorities, bear any costs of hiring or payment of compensation for such requisitioning.
- 6.5 Where the resources required to respond to a search and rescue exceed those available to any Party, or where the circumstances require significant coordination across Party

agencies, a search and rescue may develop into an emergency management response. Where a search and rescue results in State, Territory or national emergency plans or arrangements being activated, they are to be activated in support of national search and rescue response arrangements established through this agreement.

7 OPERATION OF THE NATIONAL SAR COUNCIL

7.1 Management

7.1.1 The National SAR Council is to be chaired by AMSA and the secretariat for the National SAR Council is also provided by AMSA to facilitate the implementation of this agreement.

7.1.2 Each Party will encourage the representatives from its SAR Authority to consider a whole-of-government perspective, and not just the views of its own agency.

7.2 Membership

7.2.1 Membership of the National SAR Council comprises one representative from each of:

- I. the Australian SAR Authority,
- II. each of the State and Territories SAR Authorities, and
- III. the Australian Defence Force.

7.3 Meetings

7.3.1 The Council should meet at least annually and may conduct its business out of session, providing a record is agreed between members affirming the decisions made out of session. Meetings may be held face to face or by teleconference or videoconference. Notice of meetings and agendas will be given at least one week in advance, unless otherwise agreed by the members. Meetings will not proceed unless a majority of members are able to attend.

7.4 Costs

7.4.1 Each member of the National SAR Council bears its own costs and expenses incurred in the course of Council business.

8 AMENDMENTS

8.1 The Parties may at any time review this agreement and, if they unanimously decide to modify this agreement will take all practical steps to give effect to their decision by executing a replacement agreement.

9 COMMENCEMENT AND DURATION

9.1 This agreement will commence on the date it is signed by all Parties.

9.2 The Parties may unanimously decide to terminate this agreement, and having done so each Party will do all that is practicable to terminate it.

10 COUNTERPARTS

10.1 This agreement may be executed in any number of counterparts and by the parties on separate counterparts and all counterparts taken together constitute one document.

**ENDORSED in November 2017:
By the following representatives.**

For the COMMONWEALTH:



.....
The Hon Darren Chester MP
Minister for Infrastructure and Transport



.....
Hon Michael Keenan MP
Minister for Justice

For the AUSTRALIAN CAPITAL TERRITORY



.....
The Hon Mick Gentleman MLA 30/11/17
Minister for Police and Emergency Services

Inter-governmental Agreement on National Search and Rescue Response Arrangements

For the State of NEW SOUTH WALES



.....
The Hon Troy Grant MP
Minister for Police and Emergency Services

For the NORTHERN TERRITORY



.....
The Hon Michael Gunner MLA
Minister for Police, Fire and Emergency Services

For the State of SOUTH AUSTRALIA



.....
The Hon Chris Picton MP
Minister for Police, Correctional Services, Emergency Services and Road Safety

For the State of VICTORIA



.....
The Hon Lisa Neville MP
Minister for Police

Inter-governmental Agreement on National Search and Rescue Response Arrangements

For the State of TASMANIA



.....
The Hon Rene Hidding MP
Minister for Police and Emergency Management

For the State of QUEENSLAND



.....
The Hon Mark Ryan MP
Minister for Police, Fire and Emergency Services

For the State of WESTERN AUSTRALIA



.....
The Hon Michelle Hopkins Roberts MLA
Minister for Police and Road Safety

2 JAN 2018

Appendix B – National SAR Responsibilities

DIVISION OF RESPONSIBILITY		FUNCTION TO BE PERFORMED BY, OR ON BEHALF OF, THE OVERALL COORDINATING AUTHORITY					
For land, sea and air SAR, in respect of:	Responsible Authority ¹	Provision and coordination of air SAR Assets.	Provision and coordination of land SAR Assets.	Provision and coordination of maritime SAR Assets.	Communication (other than air/surface)	Air/ground communication for land search and rescue.	Aircraft/ship communication where direct communications not available.
International civil aircraft, manned space vehicles and aircraft on the Civil Aviation Safety Authority (CASA) and Recreational Aviation Australia (RA-Aus) Registers	JRCC Australia	JRCC Australia	Police	JRCC Australia Police	JRCC Australia Police	Airservices Australia Police	Airservices Australia
Persons on or from a Vessel at Sea ²	JRCC Australia Police ³	JRCC Australia Police	Police	JRCC Australia Police	JRCC Australia Police	Airservices Australia Police	Airservices Australia Police

¹ The first SAR Authority to become aware of a SAR incident is obliged to respond until overall coordination can be transferred to the 'Best Placed' SAR Authority in accordance with the provisions of the Inter-Governmental Agreement on National Search and Rescue Arrangements 2017 and the principles set out in the National SAR Manual

² Other than those for which the ADF is responsible

³ JRCC Australia involvement when requested to arrange for the provision of aircraft or accept coordination of air search in accordance with the principles set out in the National SAR Manual

Appendices

DIVISION OF RESPONSIBILITY		FUNCTION TO BE PERFORMED BY, OR ON BEHALF OF, THE OVERALL COORDINATING AUTHORITY					
For land, sea and air SAR, in respect of:	Responsible Authority ¹	Provision and coordination of air SAR Assets.	Provision and coordination of land SAR Assets.	Provision and coordination of maritime SAR Assets.	Communication (other than air/surface)	Air/ground communication for land search and rescue.	Aircraft/ship communication where direct communications not available.
Persons and vehicles on land ⁴ ; and Persons and vessels on inland waterways and in waters within the limits of the ports of the relevant State or Territory	Police	Police JRCC Australia	Police	Police	Police	Police Airservices Australia	Police Airservices Australia
Aircraft not included in the CASA and RA-Aus registers including ultralights, para-gliders, hang-gliders, and gyrocopters (unregistered aircraft).	Police	Police JRCC Australia	Police	Police JRCC Australia	Police Airservices Australia	Police Airservices Australia	Police Airservices Australia
Australian Defence Force (ADF) and Foreign Military Personnel, Aircraft, Ships and Submarines	ADF ⁵	ADF	ADF	ADF	ADF	ADF	ADF

⁴ JRCC Australia involvement when requested to arrange for the provision of aircraft or accept coordination of air search in accordance with the principles set out in the National SAR Manual

⁵ ADF involvement in search and rescue is arranged through HQJOC (Headquarters Joint Operations Command) in accordance with the principles set out in the National SAR Manual

DIVISION OF RESPONSIBILITY		FUNCTION TO BE PERFORMED BY, OR ON BEHALF OF, THE OVERALL COORDINATING AUTHORITY					
For land, sea and air SAR, in respect of:	Responsible Authority ¹	Provision and coordination of air SAR Assets.	Provision and coordination of land SAR Assets.	Provision and coordination of maritime SAR Assets.	Communication (other than air/surface)	Air/ground communication for land search and rescue.	Aircraft/ship communication where direct communications not available.
Unidentified Distress Beacon Alerts	JRCC Australia	JRCC Australia	Police	JRCC Australia Police	JRCC Australia	JRCC Australia Airservices Australia	JRCC Australia Airservices Australia

Appendices

DIVISION OF RESPONSIBILITY		FUNCTION TO BE PERFORMED BY, OR ON BEHALF OF, THE OVERALL COORDINATING AUTHORITY					
For land, sea and air SAR, in respect of:	Responsible Authority ⁶	Provision and coordination of air SAR Assets.	Provision and coordination of land SAR Assets.	Provision and coordination of maritime SAR Assets.	Communication (other than air/surface)	Air/ground communication for land search and rescue.	Aircraft/ship communication where direct communications not available.
In respect to persons on oil and gas facilities at sea associated with the exploration, production, storage and offloading of product.	JRCC Australia Police* ⁶	JRCC Australia Police	Police	JRCC Australia Police	JRCC Australia Police	Airservices Australia Police	Airservices Australia Police

NB: This responsibility matrix relates only to search and rescue responsibilities and does not replace the responsibilities of other organisations as they relate to safety, security and environmental issues on Oil and Gas facilities.

*Responsibility for the rescue of persons from oil and gas facilities at sea will be determined in accordance with the 'Best Placed' provisions.

Will require that NOPSEMA is informed of this change.

⁶ The first SAR Authority to become aware of a SAR incident is obliged to respond until overall coordination can be transferred to the 'Best Placed' SAR Authority in accordance with the provisions of the Inter-Governmental Agreement on National Search and Rescue Arrangements 2017 and the principles set out in the National SAR Manual

Appendix C – National Operational Procedure for Transfer of Coordination

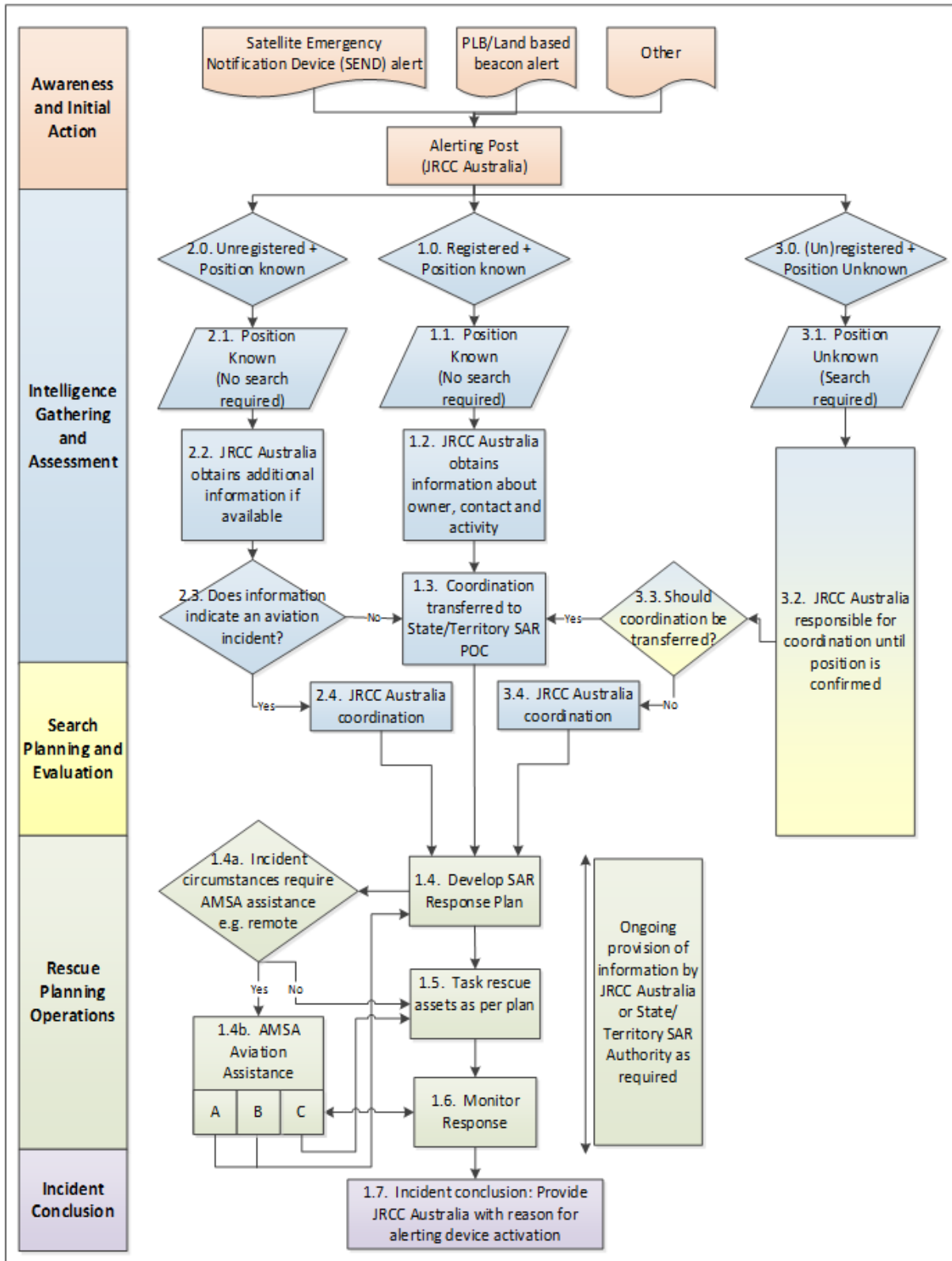

Appendices

Guidelines for Procedure to transfer coordination

1.0	The term 'position known' means that the position accuracy is nominally within 5 kilometers, and for GPS encoded positions are normally within 150 meters. An appropriately trained response team should be able to localise the final beacon position on scene in line with respective procedures.
1.3	<p>Transfer of coordination and information between JRCC Australia and State/Territory will occur with the agreed SAR point of contact in each jurisdiction, which already exists (attachment 1).</p> <p>Provision of transfer of coordination and incident information will occur both in writing and verbally:</p> <p>Written exchange – Written information will include, position information, beacon registration information if known, and any other relevant intelligence obtained.</p> <p>Verbal exchange – The recognised time of transfer of coordination will be when verbal agreement occurs.</p> <p>Example of this information is provided in Appendix D of the NATSAR Manual. The information exchange will occur almost simultaneously, normally with the written information provided first, followed by a telephone call. Other means of transferring information to the coordinating authority will be considered upon request.</p>
1.4	A response will be planned by the respective jurisdiction in line with their procedures.
1.4a	When developing the SAR Response Plan, the coordinating SAR authority may determine that aviation assistance is required from JRCC Australia due to circumstances specific to that incident e.g. the location is in a particularly remote area.
1.4b	<p>JRCC Australia can provide three types of aviation assistance:</p> <p>Identification of suitable aviation SAR assets</p> <p>Identification and briefing provided for suitable aviation SAR assets</p> <p>Identification, briefing and tasking of suitable aviation SAR assets.</p> <p>If assistance a) or b) is requested, then JRCC Australia will provide the relevant information to the coordinating authority to assist in further developing the SAR Response Plan.</p> <p>If assistance c) is requested, then JRCC Australia will task the asset but will still remain in a supporting role to the coordinating SAR Authority. The intention is for the coordination SAR Authority to have direct communications with the aircraft responding to the incident where possible. This is the best practice to ensure the SMC and the ground parties responding have real time and accurate information without delay. It is understood that there may be some communications limitations especially outside of state contracted assets but the intention is to transition to this operational practice. If this capability does not exist, JRCC Australia will provide a relay of relevant information as required.</p>
1.6	The SMC of the coordinating SAR authority has responsibility to monitor the progress of the SAR Response Plan and will be provided with updates of ongoing information if obtained by JRCC Australia.
1.7	As international SPOC, JRCC Australia is required to provide incident reports to COSPAS-SARSAT as per our international agreement, including reason for activation and number of lives saved etc. Upon incident conclusion, the coordinating SAR authority will forward this information to JRCC Australia.
2.2	If registration details are not available JRCC Australia will continue with inquiries to obtain additional information. Unless it is determined that it is an aviation incident, coordination will be transferred to the appropriate State/Territory SAR Authority.
3.2	When the position is unknown, JRCC Australia will retain coordination and take appropriate action to confirm the position. In accordance with the NATSAR Manual Volume 1, Chapter 1.2.10, JRCC Australia and the respective State/Territory SAR authority will have a discussion regarding the best placed SAR authority to take coordination, based on the incident circumstances.

State / Territory SAR Authority Points of Contact

State	Contact
NSW	Sydney Police COM Centre Rescue Coordinator (RCO)
QLD	Police SARMC for the district, backup Brisbane Police COM Centre Duty Sergeant
NT	Police COM Centre Darwin
WA	Police COM Centre Perth Duty Inspector, then as agreed for local Police contacts
SA	Police STAR Group Shift Manager, if no contact Police COM Centre
VIC	Police RCC
TAS	Police Radio Dispatch Services (RDS) Centre, Tasmania Police COM Centre Hobart
ACT	ACT Police Operations Centre
Australian External Territories	Australian Federal Police Operation Coordination Centre

Transfer of Coordination Information Exchange Requirements

Overview

In accordance with Section 1.2.30 and 1.2.35 of the manual, transfer of coordination is deemed to have taken place at the time verbal agreement is reached. The transfer of coordination is to be recorded appropriately within each Authority's incident management system.

The transfer of coordination can involve overall coordination or specific sub components of the search activity e.g. Land\Air\Sea search coordination. Transfer discussions will only be undertaken between appropriately authorised person(s) of respective SAR Authority's.

Noting that each SAR Authority has fit for purpose record keeping systems the following is to be used as a guide for information that shall be transferred electronically to another SAR agency as part of the transfer of coordination process.

Item	Comment
Timestamp	System generated Date\Time stamp
Reference telephone call for time of verbal transfer	Reference telephone call between SAR Authorities in which verbal transfer of coordination was agreed
Incident Identifier and short description	Authority Incident\CAD reference number, short title of incident and plain language description
Coordination Transfer	Details of coordination element to be transferred, possibilities include ⁷ : <ul style="list-style-type: none"> - Overall Coordination - Land Search - Sea Search - Air Search
Current Situation	Assessment of the current situation by the coordinating SAR authority
Intelligence and Actions undertaken	A summary of known information and actions completed
Incident location	Incident location details, at a minimum Latitude and Longitude (decimal degrees) are to be provided Additional positional formats can be provided, e.g. Grid Reference, embedded GPS position
Additional incident support requirements	Additional incident support requirements as agreed between SAR authorities, examples could include forward command post support, next of kin liaison, radio broadcasts etc.
Supplementary Information	Information pertaining to the target e.g. beacon registration details, target operator details and contacts, trip details

⁷ Delete those that are not applicable

Example: Transfer of Coordination information

192359 UTC Jun 2015

FM JRCC AUSTRALIA

TO [State\Territory SPOC]

INFO [As required]

INCIDENT 2015/1234 - TRANSFER OF SEARCH AND RESCUE [OVERALL COORDINATION\AIR SEARCH\LAND SEARCH\SEA SEARCH] – PLB\SEND DEVICE LOCATED XXX

Ref A. Telecon JRCC Australia \ [State\Territory SPOC] 192350 UTC JUN 2015

Ref B. NATSARMAN xx.x

1. COORDINATION TRANSFER

IN ACCORDANCE WITH REF A, JRCC AUSTRALIA HEREBY FORMALLY REQUEST THE TRANSFER OF [OVERALL\AIR SEARCH\LAND SEARCH\SEA SEARCH, IN ACCORDANCE WITH PARAGRAPH 1.2.31 OF THE NATIONAL SEARCH AND RESCUE MANUAL, FOR THE SEARCH AND RESCUE ACTION FOR RESPONSE TO THE ACTIVATION OF A [DEVICE] ACTIVATED AT [DDHHMM UTC MMM YYYY].

2. CURRENT SITUATION:

JRCC AUSTRALIA RECEIVED PLB DETECTION AT 19 2230UTC. THE JRCC HAS CONFIRMED THERE IS A PARTY OF FOUR PERSONS CANYOING IN X AREA AND THAT THEY REPORTED THEY WOULD ONLY ACTIVATE THE BEACON IN CASE OF A SERIOUS INJURY OR ACCIDENT. THE PARTY DEPARTED THIS MORNING, NO OTHER INFORMATION REGARDS SAFETY EQUIPMENT IS KNOWN. AIRCRAFT TRANSITING THE AREA HAVE BEEN REQUESTED TO REPORT ANY HEARING REPORTS IN THE AREA.

3. INTELLIGENCE AND ACTIONS UNDERTAKEN:

JRCC AUSTRALIA HAS CONTACTED THE REGISTERED BEACON OWNER EMERGENCY CONTACTS. THEY ADVISE THAT THE BEACON HAS BEEN LOANED TO X AND Y, THEY ARE CURRENTLY CANYONING IN THE X AREA WITH FOUR OTHER PERSONS. THE FOLLOWING CONTACT\COMMUNICATION DEVICES ARE IN POSSESSION OF THE REGISTERED OWNERS.

4. INCIDENT LOCATION:

A. LATITUDE\LONGITUDE: 39-14.5S 142-54.76E

B. *GRID REFERENCE: 54H 665062 5654661 UTM

C. *EMBEDDED GPS POSITION: 39-14.5S 142-54.7E

* AS APPLICABLE

5. ADDITIONAL INCIDENT SUPPORT REQUIREMENTS

IN ACCORDANCE WITH REQUEST OF [STATE\TERRITORY SPOC] JRCC AUSTRALIA HAS TASKED [RESCUE 431CHALLENGER 604 TIER 1 AIRCRAFT] ETA ON SCENE IS ADVISED AS 200112 UTCJUN 2015.

6. SUPPLEMENTARY INFORMATION, BEACON REGISTRATION INFORMATION

Appendices

Registered Beacon Details

Status

Operational

Organisation

ATTN: MANAGER OPERATIONS

Owner (Last Updated: 12/08/2015)

AMSA ER
GPO Box 2181
CANBERRA, ACT 2601

Phone: (W) 02 6230 6811

Fax: 02 6230 6868

Email: rccaus@amsa.gov.au

Remarks:

Internal Comments:

Emergency Contacts

Contact Name	Home Phone	Work Phone	Mobile Phone
SSARO on duty		1800 641 792	

Beacon Details (Last Updated: 12/08/2015)

Hex: 3EF699F53F81FE0

Manufacturer: GME - Standard Communications Pty Ltd

Manufacturer Serial #
912175012

Model: MT410G PLB

Comments: * 1AUG15 - 4WD trip with family to Mount Kosciuszko. 2 x Adults and 2 x Children. Returning sunday night 2AUG15.

Internal Comments

Primary Use: Vehicle Details (Last Updated: 12/08/2015)

Make/Model: Toyota Rav4

Year: 2008

Rego: JU45KL

Colour: Black

Call Sign

UHF: No

HF: No

Satellite Phones

REGARDS,

JRCC AUSTRALIA

Appendix D

Overview

- Appendix D-1 Distress Emergency Signals
- Appendix D-2 Maritime SAR Recognition Codes
- Appendix D-3 Plotting Symbols
- Appendix D-4 Sighting and Hearing Techniques
- Appendix D-5 Tables and Graphs
- Appendix D-6 Probable Positions of Error
- Appendix D-7 Worksheets
- Appendix D-8 Aircraft Accident Site Precautions
- Appendix D-9 Civil Aircraft Search and Rescue Assets (SRAs)
- Appendix D-10 Coastal Datum Search and Rescue Planning

Appendix D-1 Distress Emergency Signals

Overview

Many signals have been devised over the years to signal a condition of distress or other emergency status. Those listed in this Appendix are those which are most common, have been accepted by international agreement or national custom, or which may be significant for occasional use by SAR assets.

Because of the large number of possible signals of various types that may be used to indicate an emergency condition or may be used for emergency communication, this list is not all-inclusive.

International Distress Signals

- a) A gun or other explosive signal fired at intervals of about one minute;
- b) A continuous sounding of any fog-signalling apparatus;
- c) Rockets or shells, throwing red stars fired one at a time at short intervals.
- d) A signal made by any signalling method consisting of the group ...---... (SOS) in the Morse Code;
- e) A signal sent by radiotelephony consisting of the spoken word 'Mayday'
- f) The International Code Signal of distress indicated by the code group NC; (See the International Code of Signals for other code groups with emergency significance.)
- g) A signal consisting of a square flag having above or below it a ball or anything resembling a ball;
- h) Flames on a vessel (as from a burning tar barrel, etc.);
- i) A rocket parachute flare or a hand flare showing a red light;
- j) A smoke signal giving off a volume of orange-coloured smoke;
- k) An orange coloured sheet with a black square and circle or a black "V" or other appropriate symbol;
- l) Slowly and repeatedly raising and lowering arms outstretched to each side;
- m) The radiotelephone alarm signal consisting of two tones transmitted alternatively over periods of from 30 seconds to 1 minute;
- n) Signals transmitted by Emergency Position Indicating Radio Beacons, EPIRB's or Personal Locator Beacons (PLB's), Emergency Locator Transmitters (ELT's);
- o) Approved signals transmitted by radio communication systems;
- p) A dye marker; and
- q) Transponder Squawk Codes 7700 Emergency, 7600 Communications failure, 7500 Unlawful interference.

Search and Rescue Signals – Australian Area

Signals with Surface Craft

When it is necessary for an aircraft to direct a surface craft to the place where an aircraft or surface craft is in distress, the aircraft shall do so by transmitting precise instructions by any means at its disposal. If such precise instructions cannot be transmitted or when necessary for any other reason, the instructions shall be given by using the procedure prescribed herein.

The following procedures performed in sequence by an aircraft shall mean that the aircraft is directing a surface craft towards an aircraft or a surface craft in distress:

- a) Circling the surface craft at least once;
- b) Crossing the projected course of the surface craft, close ahead at a low altitude, opening and closing the throttle or changing the propeller pitch; and
- c) Heading in the direction in which the surface craft is to be directed.

The following procedure performed by an aircraft shall mean that the assistance of the surface craft to which the signal is directed is no longer required:

- a) Crossing the wake of the surface craft close astern at a low altitude, opening and closing the throttle or changing the propeller pitch.
- b) Repetition of such procedures shall have the same meaning. Current maritime signalling procedures include:
 - i) For acknowledging receipt of signals:
 - ii) The hoisting of the Code Pennant (vertical red and white stripes) close up (meaning understood);
 - iii) The flashing of a succession of T's by signal lamp in Morse code; and
 - iv) The changing of heading.
 - c) For indicating inability to comply:
 - i) The hoisting of the international flag N (a blue and white checked square); and
 - ii) The flashing of a succession of Ns in Morse code.

Civil Air-Ground Code

Australian Civil Authorities use the following air-ground codes:

Signal	Meaning
Aircraft orbits ground party at low level changing engine noise	I require your attention
Aircraft flies overhead ground party at low level and sets off in a particular direction.	Follow aircraft in same direction
Aircraft rocks wings and orbits.	Investigate object/position underneath aircraft orbit
Aircraft drops smoke on a particular location	Investigate object/position adjacent to smoke
Aircraft drops message canister.	Retrieve and read instructions contained in the canister

Table D-1:1 Ground Air Visual Signal Code

International SAR Signals

The following visual signals are internationally recognised. They are authorised for use in the Australian SRR.

Number	Message	Code Symbol
1	Require Assistance	V
2	Require Medical Assistance	X
3	Proceeding in this Direction	
4	Yes or Affirmative	Y
5	No or Negative	N

Table D-1:2 Ground-Air Visual Signal Code for Use by Survivors

3.6.1 **Note:** If in doubt use International Signal – SOS

Number	Message	Code Symbol
1	Require Fodder	FF
2	Require Evacuation	III
3	Power Failure	VI

Table D-1:3 Ground-Air Visual Signal Code for Use in Civil Emergencies

Notes:

1. Aldis Lamp Signals
 - a) Red flashes indicate not understood
 - b) Green flashes indicate message understood
2. Air-Ground Signals

The following signals by aircraft mean that the signals have been understood:

 - a) During hours of daylight – rocking the aircraft’s wings
 - b) During hours of darkness – by flashing the aircraft’s landing or navigation lights ON and OFF twice. Lack of the above signals indicates that the message has not been understood.
3. Tables D-1:1, D-1:2 and D-1:3 conform to ICAO and NATO standards

Appendix D-2 Maritime SAR Recognition Code (MAREC)

Overview

The purpose of this Code is to facilitate the communication of essential descriptive information regarding merchant ships and small craft within and between SAR maritime organisations.

The MAREC Code is in two parts:

- Part 1 – Merchant Vessels; and
- Part 2 – Small Craft.

All messages should be preceded with the prefix MAREC followed by a local serial number, assigned by the RCC.

The message should contain all the lettered identification groups as separate paragraphs. If the information is not known, the symbol UNK should be inserted or alternatively the symbol NA, where the lettered group is not applicable.

Fishing vessels have not been included due to the multiplicity of types and configurations. Use should be made of the Merchant Vessels description code to report the description of fishing vessels.

Part 1 – Merchant Vessels

Merchant Vessels MAREC Messages

The Message is composed of the following identification groups and will be transmitted in the following sequence:

A	Type of vessel - name - call sign
B	Superstructure - location - colour
C	Hull profile - colour
D	Sequence of uprights
E	Length
F	Condition of loading
G	Other characteristics.

Table D-2:2MAREC – Local Serial Number

A. Type of Vessel – Name – Callsign

Merchant ships are classified as follows:

VOICE	TLX/RTG
Passenger ships	PAX
Ferry	FERRY
Tankers	TANK
Bulk carriers	BULK
General cargo ships	GEN
Coaster	COAST
Fishing vessels	FISH
Container ships	CONT
Specialised ships	SPEC

Table D-2:3Mership Classifications

The name and callsign is added to the above classification.

For specialised vessels, the specific type of vessel should be given, as appropriate, e.g. gas carrier, tug, icebreaker, etc.

Example:

Voice: ALFA, SPECIALISED SHIP GAS CARRIER, FLYING DRAGON, CHARLIE GOLF HOTEL INDIA.

TLX/RTG: A/SPEC/GAS CARRIER/FLYING DRAGON/CGHI

B. Superstructure – Location and Colour

Superstructures are referred to as being located forward, midship or aft or a combination of these positions, and may be described as long or short. Colour is given in plain language.

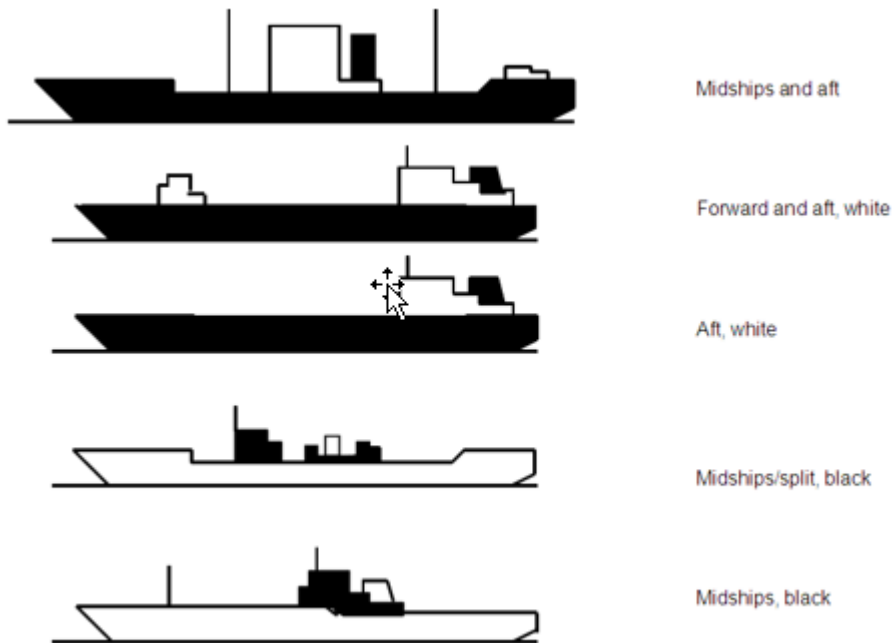

Figure D-2: 7 Superstructure Locations/Colour

Note: A superstructure that has a very distinct gap, as in the fourth illustration above should be reported as “location” split.

Example (as in the first illustration above)

Voice: BRAVO, SUPERSTRUCTURE MIDSHIP AND AFT, WHITE

TLX/RTG: B/MIDSHIPS AND AFT/WHITE

C. Hull – Profile and Colour

The hull profile is divided into three sections numbered 1, 2 and 3 from stem to stern as follows:

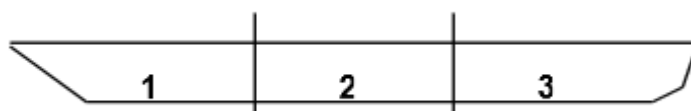

Figure D-2:8 Hull Division

If any section of the main weather deck of a vessel (except for superstructure) is raised, this is reported by its respective number as shown below. Should there be a break between deck raises, an oblique line (voice - 'SLANT') will be inserted in between the relevant section numbers. Should there be no break as referred to above, the numbers will be written consecutively.

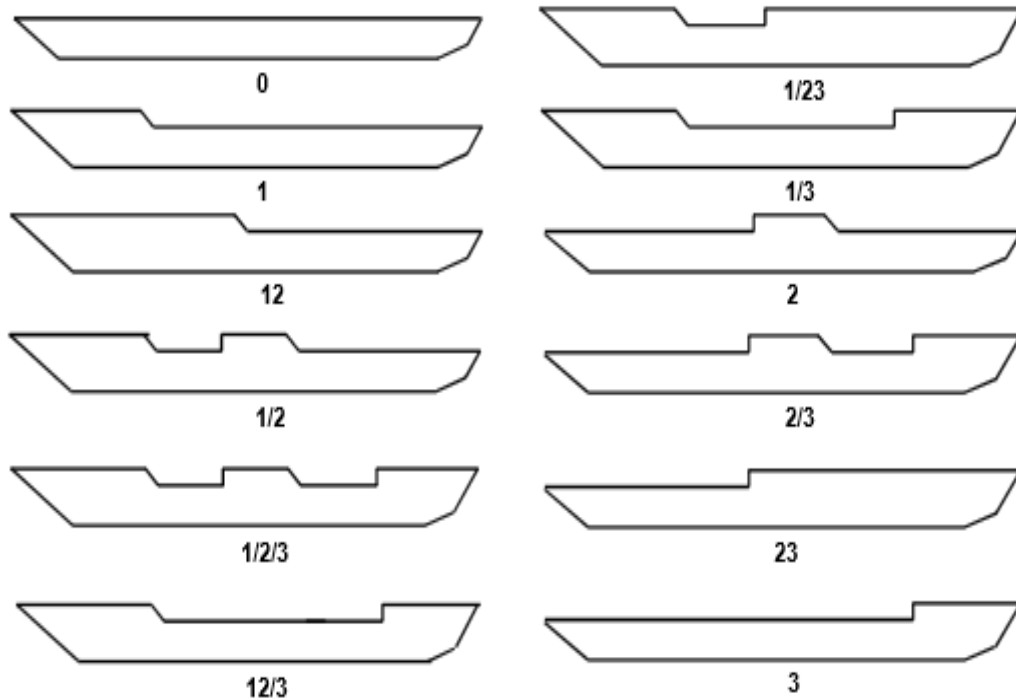

Figure D-2:9 Full Profiles

Note of Caution:

Do not confuse raises in the decline with bulwarks which extend the height of the hull profile about 1 m and are used to protect deck cargo and personnel from washing over the side. They look like fences around exposed weather decks and can be usually recognised by the presence of small holes for deck drainage (scuppers) and the lack of handrails (see Figure D-2:12 below).



Figure D-2:10 Bulwark

The colour of the hull is given in plain language.

Example:

Voice: CHARLIE, PROFILE ONE TWO SLANT THREE, BLACK

TLX/RTG: C/12/3/BLACK.

D. Uprights

Uprights include everything, other than the profile and the superstructures that are prominent and can clearly be seen at a distance. The uprights are reported from stem to stern according to the list below:



Voice	TLX/ RTG	Description	Illustration
Mast	M	Slender posts consisting of a lower section with a thinner upper section. Used to support signals, flags, navigation lights, radar antennae etc. Generally the highest of the uprights.	
Kingpost	K	Slender uprights resembling the thickness or heaviness of the lower section of masts. They are used to support cargo booms. If there is a pair of king posts athwartships (perpendicular to the vessel's centreline), the pair is reported as one kingpost. A kingpost with mast extensions is reported as a mast.	
Funnel	F	Used to exhaust the vessel's main propulsion systems. Most vessels have one although some of the older ships have more.	
Crane	C	Self-contained mechanisms with a boom extending from them.	
Gantry	G	Mobile structure limited to fore-aft movement supporting a central crane.	

Figure D-2:11 Uprights

Uprights located close to a superstructure such that they cannot be clearly seen from a distance should not be included.

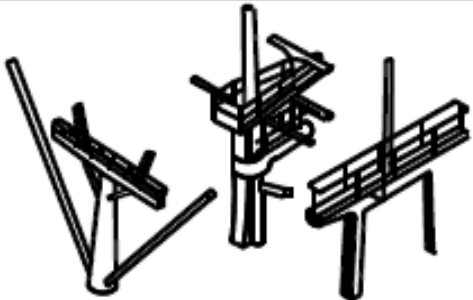
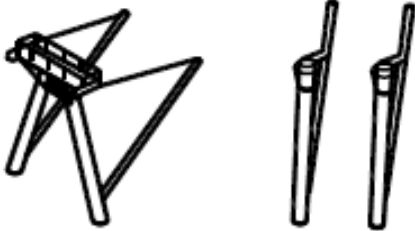

Figure D-2:12 Example of Uprights

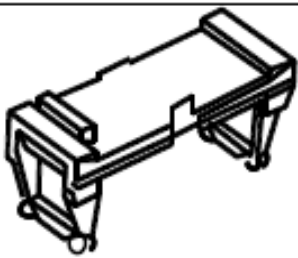
Example:

Voice: DELTA, MAST, KINGPOST, MAST, KINGPOST, FUNNEL

TLX/RTG: D/M K M F

E. Length

Length is the length overall (LOA) given in metres.

Note: Length can be estimated by observing the vessel's lifeboats, normally 10 metres long, in proportion to the ship's length.

Example:

Voice: ECHO, TWO ZERO METRES

TLX/RTG: E/LOA 20

F. Conditions of Loading

The condition of loading is indicated as follows:

Voice	TLX/RTG	Description	Illustration
Light	Light	Carrying only fuel and stores. Sitting high in water. Propeller and rudder partly exposed. Difficult to manoeuvre.	
In ballast	Ball	Carrying ballast. Sitting high in water. Propeller and rudder normally submerged. Large amount of lower hull paint showing.	
Partially loaded	Part	Sitting well in water. Fair amount of lower hull paint showing.	
Fully loaded	Load	Sitting deep in the water. Little, if any, lower hull paint showing.	

Figure D-2:13 Conditions of Loading

Example

Voice: FOXTROT, PARTIALLY LOADED

TLX/RTG: F/PART

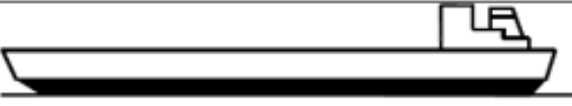
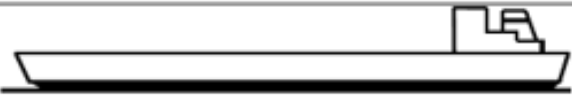
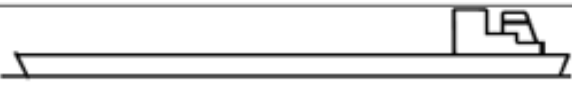
G. Other characteristics

Other prominent characteristics should be given, e.g. stack insignia, conspicuous deck cargo, or other distinguishing marks or colour variations, e.g. name in big letters on ship’s side or company insignia painted on side of hull. In the message, such specific characteristics should be given in full.

Example:

Voice: GOLF, RAILROAD CARS ON DECK

TLX/RTG: G/RAILROAD CARS ON DECK

Complete example Merchant Ship

The following illustrates a typical merchant vessel and how it would be described in a message according to this system.

Voice:	TLX/RTG:
MAREC 5/03 RCC AUSTRALIA ALFA, GENERAL CARGO SHIP, ARAFURA, VICTOR ROMEO ROMEO YANKEE BRAVO, SUPERSTRUCTURE AFT, WHITE CHARLIE, PROFILE ONE, SLANT THREE, BLACK DELTA, MAST, MAST, MAST, FUNNEL, KINGPOST ECHO, TWO FOUR ZERO METRES FOXTROT, PART GOLF, NOT APPLICABLE	MAREC 5/76 RCC AUSTRALIA A/GEN/ARAFURA/VRRY B/AFT/WHITE C/1/3/BLACK D/M M M F K E/LOA 240 F/PART G/NA.



Figure D-2:14 Typical Merchant Ship

Appendices

Part 2 – Small Craft

Small Craft MAREC Message

The message is composed of the following identification groups and will be transmitted in the following sequence:

A	Type of craft/ number of hulls – name – callsign or ship station identity – use
B	Make - distinctive markings
C	Motor installation or rigging
D	Construction - material – colour
E	Stern – stern
F	Type of bottom
G	Length.
H	Other characteristics
I	Number of persons on board.

Table D-2:4 MAREC - Local Serial Number

A. Type, configuration and superstructure of craft/number of hulls, name, callsign and use

Type is based on primary means of propulsion.

Propulsion	Type	Voice	TLX/RTG
Motor	Motor Boat	Motor	MOT
Sail	Sailing Boat	Sailing	SAIL
Oars	Rowing Boat	Rowing	ROW
Paddles	Canoe	Canoe	CAN
Motor and sail (in equal proportion)	Motor/Sailer	Motorsail	MOTSAIL
Various	Inflatable	Inflatable	INFLAT

Table D-2:5 Type of Small Craft

Configuration is based on decked-in watertight areas.

Voice	TLX/RTG	Description
Open	O	Free of decks that enclose a watertight area
Part Open	PO	Partly decked to create watertight areas
Closed	CL	Fully decked so that, with all hatches closed and bungs in, the entire hull volume is watertight
Superstructure		
Full Cabin	FC	Cabin superstructure from bow to stern
Part Cabin	PC	Any cabin superstructure not from bow to stern
Full Raised Deck	RD	Entire deck level is raised to provide accommodation in the hull. Identified by the presence of windows in the hull without any superstructure
Part Raised Deck	PD	Where only part deck level is raised as above

Table D-2:6 Configuration of Small Craft

When reporting the above both voice and TLX/RTG items should be incorporated in one group as below:

An open, part cabin motor boat should be reported as:

- Voice: MOTOR OPEN PART CABIN
- TLX/RTG: MOTOPC

A closed, part cabin sailing boat should be reported as:

- Voice: SAIL CLOSED PART CABIN
- TLX/RTG: SAILCLPC

Where the number of hulls is more than one, adding the words or group as follows should indicate this:

- 2 hulls - Catamaran – CAT
- 3 hulls -Trimaran - TRI

The craft's name, call sign and use should be added to words or groups above. Under use, indicate the purpose for which the craft is being used, e.g. fishing, pilot boat, off-shore racer, etc.

Example:

Voice: ALFA, MOTOR PART OPEN PART CABIN CATAMARAN, LUCKY LADY, NAVIS ONE THREE, PLEASURE

TLX/RTG: A/MOTPOPC/CAT/LUCKY LADY/NAVIS 13/PLEASURE

B. Make and Distinctive Markings

The make and distinctive markings should be given in plain language.

Example:

Voice: BRAVO, MAKE STORTRISS, SAIL MARKINGS TWO OVERLAPPING TRIANGLES WITH POINTS UP AND NUMBER SIERRA ONE THREE EIGHT

TLX/RTG: B/STORTRISS/SAILMARKINGS TWO OVERLAPPING TRIANGLES POINTS UP/ S138

C. Motor Installation or Sail Rigging

The motor installation is given according to the figures shown below:

Illustration	Voice	TLX/RTG
	Outboard motor, if applicable with the addition Double or Triple.	OUTB OUTB2 OUTB3
	Inboard motor	INB
	Jet	JET
	Aquamatic if applicable with the addition Double or Inboard/Outboard	AQUA AQUA2 INBOARD/OUTBOARD



Figure D-2:15 Motor Installation



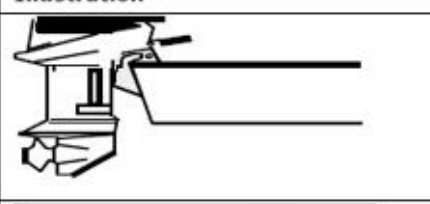
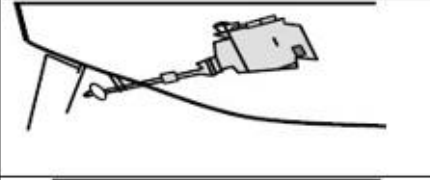
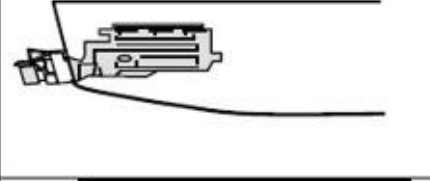
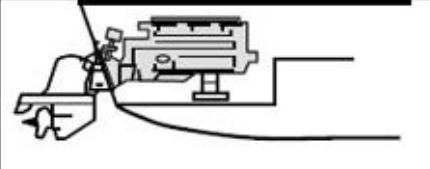

Example

Voice: CHARLIE, OUTBOARD MOTOR, DOUBLE

TLX/RTG: C/OUTB 2

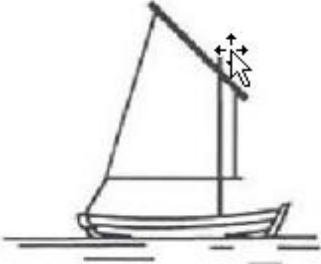
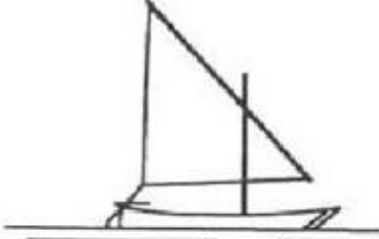
Rigging (sailing boats) - Type of rigging is described on sailing boats and motor sailers according to the figures below. (The number of masts is denoted by the appropriate number):

Illustration	Voice	TLX/RTG
 <p>A line drawing of a sailboat with a single mast and a large, curved sail. The sail is attached to the mast at the top and to the deck at the bottom. The boat is shown on a simple horizon line representing the water.</p>	Jib Rig	JIB
 <p>A line drawing of a sailboat with a single mast and a rectangular sail. The sail is attached to the mast at the top and to the deck at the bottom. The boat is shown on a simple horizon line representing the water.</p>	Spirit Rig	SPRI

	<p>Gaff Rig</p>	<p>GAFF</p>
	<p>Lug Sail</p>	<p>LUG</p>
	<p>Lanteen Sail</p>	<p>LAT</p>
	<p>Sloop Rig</p>	<p>SLOOP</p>
	<p>Junk Rig</p>	<p>JUNK</p>
	<p>Yawl</p>	<p>YAWL</p>

	Ketch	KETCH
	Schooner	SCHON

Figure D-2:16 Sailing Rigging

These boats have the capability to carry a bowsprit, that is a spar extending from the bow to which headsails are attached. These are reported on:

Voice: Bowsprit or

TLX/RTG: BS.

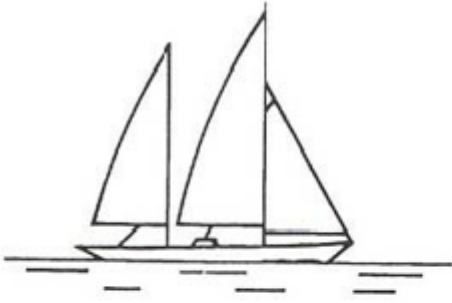
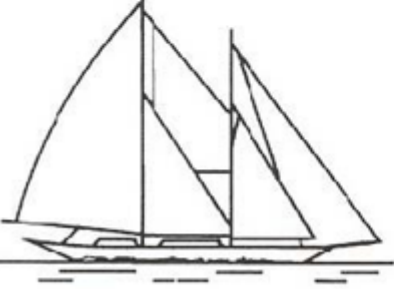
The difference between a ketch and a yawl is:

- a) The ketch's aft mast is stepped forward of the rudder post; and
- b) The yawl's mast is stepped behind the rudder post.

Most sailing boats carry sails known as "extras" to improve the boat's performance in specific conditions and include spinnakers, spinnaker staysails, jib staysails, main staysails and mizzen staysails. If these sails are in use, identification of the yacht's rig becomes more difficult. These should be reported in section H.

Name	Voice	TLX/RTG
Spinnaker	Spinnaker	SPIN
Spinnaker Staysail	Spinnaker Staysail	SPINSS
Jib Staysail	Jib Staysail	JIBSS
Main Staysail	Main Staysail	MAINSS
Mizzen Staysail	Mizzen Staysail	MIZZENS

Table D-2:7 Sail Types

D. Construction/Material/Colour

Construction

Two different types of construction exist, viz. clinker built and carvel built or smooth sided.



		Note: Some glass fibre boats are moulded to resemble clinker built and should be so described in this Code.
Clinker	Carvel	

Figure D-2:17 Construction

Material

The materials commonly used to construct small craft are wood, metal, glass reinforced plastic (fibreglass) (GRP), rubber (inflatables) or ferro- cement. Construction material and colour should be given in voice reports and given the abbreviations WOD, MTL, GRP, INFLAT or FERC in TLX/RTG reports.

Example:

Voice: DELTA, CLINKER, GLASS FIBRE, WHITE

TLX/RTG: D/CLINKER/GRP/WHITE.

E. Stem/Stern

Stem and stern designs are described according to the figures below:



STEM	VOICE	TLX/RTG
	Straight stem	STR
	Clipper stem	CLIP
	Falling stem	FALL

Figure D-2:18 Stem Designs

Example:

Voice: ECHO, FALLING STEM, CANOE STERN

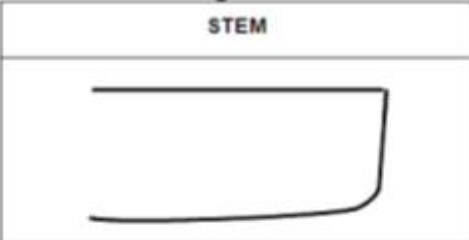
TLX/RTG: E/FALL/CAN

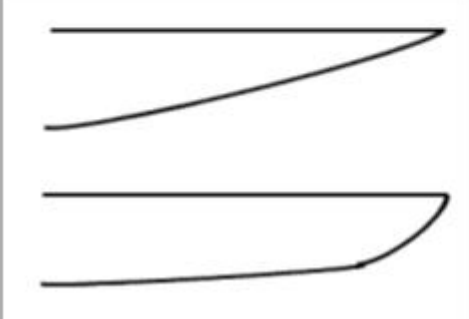
F. Type of Bottom

Bottom types are described according to the figures below:



Bottom	Voice	TLX/RTG
	V-bottom	VBOT
	Flat bottom	FLAT
	Round bottom	ROUND
	Ribbed bottom	RIB
	Keel	KEEL
	Fin-keel (where double fin-keel, add the word "double")	FIN
	Centre-board	CB

Figure D-2:19 Bottom Designs

Appendices

Example:

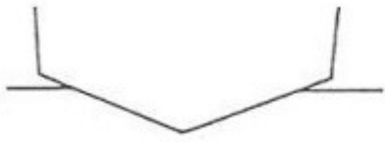
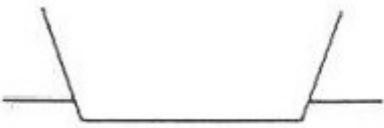
Voice: FOXTROT, RIBBED BOTTOM

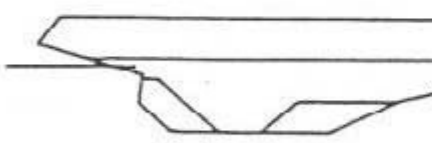
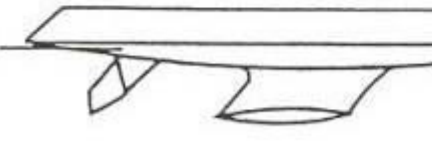
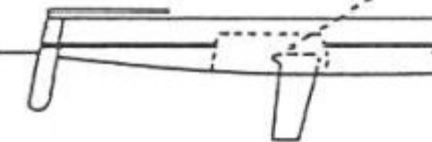
TLX/RTG: F/RIB

G. Length

Length is the length overall (LOA) given in metres.

Example:

Voice: GOLF, TWO ZERO METRES

TLX/RTG: G/LOA/20.

H. Other Characteristics

Other characteristics should be included to describe certain details that might facilitate identification, e.g. flying bridge, windscreens, dodger, spinnaker sail colouring, pulpit, pushpit, steering vane etc.

Example:

Voice: HOTEL, RED SPINNAKER

TLX/RTG: H/RED SPINNAKER.

I. Number of Persons on Board (POB)

Example:

Voice: INDIA, THREE

TLX/RTG: I/3.



Figure D-2:20 Complete Example: Motor Boat









Voice	TLX/RTG
MAREC 7/03, RCC AUSTRALIA ALFA, MOTORBOAT PART CABIN, GALANT, VICTOR KILO ONE EIGHT ZERO, PLEASURE BRAVO, MAKE SOLO TWO FIVE CHARLIE, INBOARD MOTOR DELTA, CLINKER, GLASS FIBRE, WHITE ECHO, FALLING STEM, SQUARE STERN FOXTROT, V- BOTTOM GOLF, SEVEN AND A HALF METRES HOTEL, PULPIT FORWARD, WINDSCREEN ONE AFT EDGE OF CABIN WITH A RED DODGER INDIA, TWO	MAREC 7/76 RCC AUSTRALIA A/MOTPC/GALANT/VK180/PLEASURE B/SOLO/25 C/INB D/CLINKER/GRP/WHITE E/FALL/SQUARE F/VBOT G/LOA 7.5 H/PULPIT FORWARD, WINDSCREEN ON AFT EDGE OF CABIN WITH RED DODGER I/2

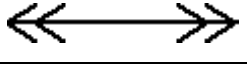

Figure D-2:21 Complete Example: Sailing Boat

Voice	TLX/RTG
MAREC 8/03, RCC AUSTRALIA ALFA, SAILING PART CABIN, FAMILY OF MAN, VICTOR KILO SEVEN FOUR EIGHT TWO, OFF SHORE RACING BRAVO, MAKE PETERSON FOUR ZERO, SAIL MARKINGS SIERRA ONE ONE CHARLIE, MASTHEAD SLOOP RIG DELTA, CARVEL, WOOD, BLACK WITH WHITE CABIN ECHO, FALLING STEM, NEGATIVE TRANSOM STERN FOXTROT, KEEL GOLF, EIGHT METRES HOTEL, PULPIT FORWARD INDIA, TWO	MAREC 8/03, RCC AUSTRALIA A/SAILPC/ FAMILY OF MAN/NAVIS 12/PLEASURE B/PETERSON 40/S 11 C/SLOOP D/CARVEL/WOOD/BLACK WITH WHITE CABIN E/FALL/NTRANS F/KEEL G/LOA 8 H/PULPIT FORWARD I/2

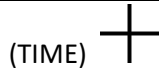
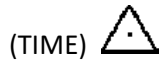
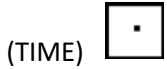
Appendix D-3 Plotting Symbols

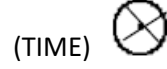
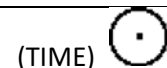
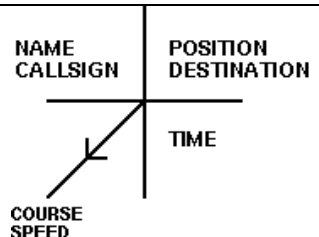
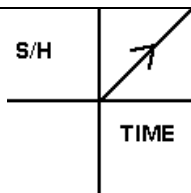
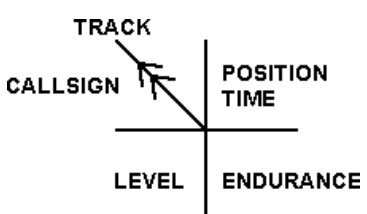
Symbol	Description
	Heading and TAS
	Track and ground speed
	Wind velocity
	Position line
	Transferred position line
	Average position line
	Air position
	Dead reckoning position
	Most probable position (MPP)
	Fix (position line)
	Fix (Other than position line – RADAR, GPS etc.)
	Visual fix (pin-point)
	Ship position
	Sighting and Hearing Reports red - probable black - all other sighting and hearing reports
	Aircraft position

Appendix D-4 Sighting and Hearing (SHR) Techniques

Listening Techniques

It is important when questioning an individual either in person or over the phone to actively listen to the information being provided. Practice the following listening techniques when questioning an individual during a SAR incident.

- a) Put the individual at ease;
- b) Remove distractions: don't doodle, tap or shuffle paper;
- c) Empathise with the individual: attempt to see the other person's point of view;
- d) Be patient: allow plenty of time and don't interrupt;
- e) Ask questions: this encourages the individual and shows that you're listening; and
- f) Stop talking: you can't listen if you're talking.

Open Questions

Open questions are a good way to question an individual. Open questions avoid influencing or guiding the individual in their answer. This ensures the integrity of the answers given.

For example: What was the colour of the aircraft you saw? Open questions usually begin with:

- a) How;
- b) Where;
- c) When;
- d) What;
- e) Who; or
- f) Why.

Closed Questions

Closed questions follow on from an open question, helping to refine the information already given. They usually require a yes or no answer and are good for gaining information quickly.

For example: Are you saying the colour of the aircraft was white?

The closed question usually begins with:

- a) Do;
- b) Is;
- c) Are;
- d) Can; or
- e) Have.

Leading Questions

The problem with leading questions is that they can elicit unreliable information. The individual being questioned may tell you what they think you want to hear.

For example, do not ask: 'You say you saw an aircraft. Was it white with a red tail?' Ask: 'You say you saw an aircraft. What colour was it?'

Instructions for Completing Sighting and Hearing Reports

The objective of the Sighting or Hearing Report is to obtain the maximum information available from an observer at the initial contact.

The following points assist persons untrained in SAR to correctly complete the Sighting and Hearing Report:

- a) When taking a call, introduce yourself with your organisation such as 'Australian Search and Rescue'.
- b) Establish follow-up by first obtaining a call back number and the person's availability.
- c) Print CLEARLY on the Sighting or Hearing Report.
- d) Number each report by referral to the Sighting and Hearing Log.
- e) If you find that a component of the report is important, put the caller on hold and obtain the attention of the Intelligence Officer. Use your initiative.
- f) Time. Be cautious: use local time only. This is very critical: try to narrow down an exact time. Record how the time was assessed. If the operation is in an area near a State or Territory border, be mindful of time changes. Also be aware of Daylight Saving Time.
- g) target location. Attempt to obtain as much detail as possible. If necessary, ask pointed questions. Height may be 'low', 'well above the hills', 'just above the trees'.
- h) Remarks. Be on the lookout for key words. Words like 'slow' can help to assess a report.
- i) Target description. For aircraft searches, the broadcast is normally a little vague and you must be likewise. For example, do not ask if the aircraft was a high-wing aircraft, as the caller may tend to agree with you.
- j) Weather. Obtain accurate reports of cloud, rain, and fog. Most people will report wind speed as 'light' or 'strong'. Direction may be only known as 'north'.
- k) Other witnesses. Obtain full details and interview these separately. This may help to verify parts of another report.
- l) Reliability. Annotate only if this is obvious, for example, whether the person reporting was a police officer or an intoxicated person.
- m) Final check. Check the entire form before hanging up. Ensure the form is SIGNED, DATED and your NAME IS PRINTED.

Sighting and/or Hearing Report for Missing Aircraft

SAR INCIDENT NUMBER	/
---------------------------	---------

OBSERVER AND LOCATION DETAILS

Sighting or Hearing	Reported by	Address	Phone
Time (6 figure) LOCAL UTC	How determined	Observer's location	
Location of Aircraft from Observer			
Aircraft Heading	Aircraft Height	Mode of operation (Level, Climbing etc.)	
REMARKS (Engine Noise, Erratic Behaviour, Smoke, Circling etc)			

DESCRIPTION OF AIRCRAFT AND WEATHER

AIRCRAFT

Aircraft Colours		Aircraft Markings	
Number of engines	Wing position	Tail	Undercarriage (Up or Down)

WEATHER

Wind	Visibility	Cloud	General conditions
------	------------	-------	--------------------

OTHER WITNESSES

Name	Address	Phone
Name	Address	Phone

RCC ASSESSMENT

Assessment and Comment (NOTE: Ask Reporter to phone again if additional detail is recalled)			
REPORT TAKEN BY		DTG of Report (6 figure) UTC	
Intelligence Officer	Plotted	Recorder	Other

Page ____ of ____

Sighting and Hearing Report – Generic

 Australian Government Australian Maritime Safety Authority				
Sighting/Hearing Report				
Observer/Asset Location (Complete all mandatory fields)				
Name/Callsign **			Phone **	
Location Name				
Location Coordinates	S	E	Uncertainty	(Kms)
Remarks				
Observed Object Position				
Position				
Location Coordinates **	S	E	Uncertainty	(Kms)
DTG **	<input type="checkbox"/> UTC / <input type="checkbox"/> Local		Uncertainty	(Mins)
Remarks				
Description (Select the relevant checkboxes)				
Report Type	<input type="checkbox"/> Sighted	Type	<input type="checkbox"/> Vessel	<input type="checkbox"/> Aircraft
	<input type="checkbox"/> Heard		<input type="checkbox"/> Person	<input type="checkbox"/> Signal
				<input type="checkbox"/> Vehicle
				<input type="checkbox"/> Other
				<input type="checkbox"/> Pollution
Remarks				
Weather (Complete the details using the laminated Pick List)				
Other Witnesses				
Name	Phone	S/H Report Completed?	Notes	
		<input type="checkbox"/> Yes / <input type="checkbox"/> No		
		<input type="checkbox"/> Yes / <input type="checkbox"/> No		
		<input type="checkbox"/> Yes / <input type="checkbox"/> No		
Assessment				
Incident Number **				
Priority	<input type="checkbox"/> Priority	Assessment	<input type="checkbox"/> Unassessed	<input type="checkbox"/> Possible
	<input type="checkbox"/> Routine		<input type="checkbox"/> Negative	<input type="checkbox"/> Definite
Annotation				
Note				
Admin				
Report Taken By			Hardcopy S/H No	
Report Taken @			Electronic ID No	

** Mandatory Fields

Appendix D-5 Tables and Graphs

Local Wind Current

Figure D-5:1 Local Wind Current Graph

Leeway Tables (kt)

Table D-5:1 Leeway Speed and Direction Values for Drift Objects

Table D-5:2 Sub-Table for Maritime Life Rafts with Deep Ballast Systems and Canopies

Sweep Width Tables For Visual Search Over Water

Table D-5:3 Uncorrected Visual Sweep Width for Vessels and Small Boats

Table D-5:4 Weather Correction Factors for All Types of Search Facilities

Table D-5:5 Uncorrected Visual Sweep Widths for Merchant Ships [km (NM)]

Table D-5:6 (1) Uncorrected Sweep Widths for Fixed-Wing Aircraft (NM) at 500 feet and 1000 feet.

Table D-5:6 (2) Uncorrected Sweep Widths for Fixed-Wing Aircraft (NM) 1500 feet and 2000 feet.

Table D-5:7 (1) Uncorrected Sweep Widths for Helicopters (NM) – Maritime 500 feet and 1000 feet

Table D-5:7 (2) Uncorrected Sweep Widths for Helicopters (NM) – Maritime 1500 feet and 2000 feet

Table D-5:8 Speed (velocity) Correction Factors for Helicopter and Fixed-Wing Aircraft Search Facilities

Sweep Width Tables For Visual Search Over Land:

Table D-5:9 Uncorrected Sweep Widths for Visual Land Search [km (NM)]

Table D-5:10 Correction Factors – Vegetation and High Terrain

Probability of Detection

Figure D-5:13 Probability of Detection Graph

Local Wind Current

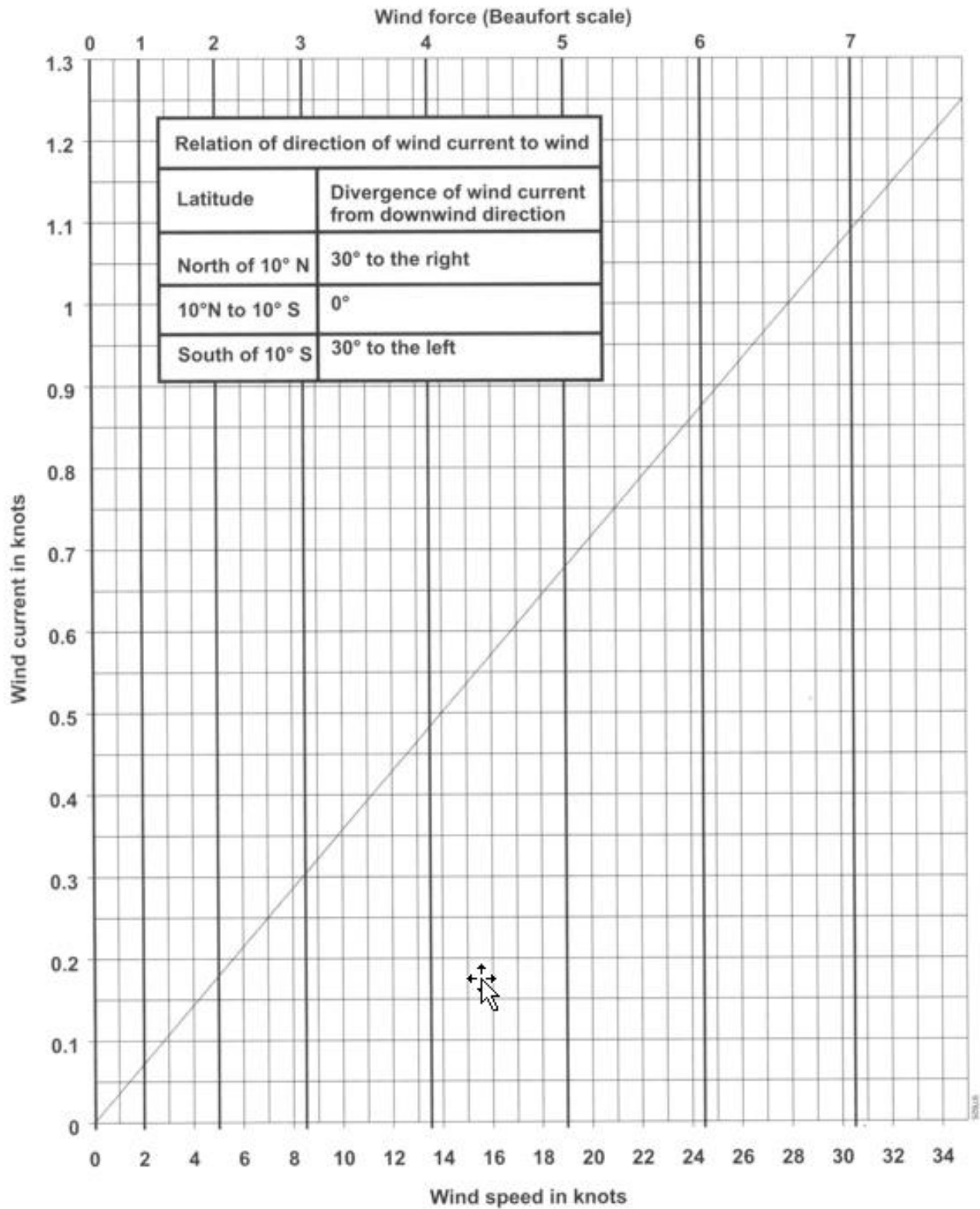

Figure D-5:1 Local Wind Current Graph

Appendices

Leeway Tables

Leeway Target Class				Leeway Speed		Divergence	
Category	Sub Categories	Primary Leeway Descriptors	Secondary Leeway Descriptors	Multiplier	Modifier (kt)	Angle (deg)	
PIW				0.011	0.07	30	
	Vertical			0.005	0.07	18	
	Sitting			0.012	0.00	18	
	Horizontal	Survival Suit		0.014	0.10	30	
		Scuba Suit		0.007	0.08	30	
		Deceased		0.015	0.08	30	
Survival Craft	Maritime Life Rafts	No Ballast Systems		0.042	0.03	28	
			no canopy, no drogue	0.057	0.21	24	
			no canopy, w/ drogue	0.044	-0.20	28	
			canopy, no drogue	0.037	0.11	24	
			canopy, w/ drogue	0.030	0.00	28	
	Shallow Ballast Systems and Canopy	no drogue	0.029	0.00	22		
		with drogue	0.032	-0.02	22		
		Capsized	0.025	0.01	22		
	Deep Ballast Systems & Canopies	(See Table I-2 for Levels 4-6)	0.017	-0.10	8		
	Other Maritime Survival Craft	life capsule			0.030	0.02	13
		USCG Sea Rescue Kit			0.038	-0.08	22
Aviation Life Rafts	no ballast, w/canopy Evac/ Slide	4-6 person, w/o drogue		0.025	-0.04	7	
		46-person		0.037	0.11	24	
Person-Powered Craft	Sea Kayak	W/ Person on aft deck		0.028	-0.01	15	
	Surf board	w/ person		0.011	0.24	15	
	Windsurfer	w/ person and mast & sail in water		0.020	0.00	15	
Sailing Vessels	Mono-hull	Full Keel	Deep Draft	0.023	0.10	12	
		Fin Keel	Shoal Draft	0.030	0.00	48	
Power Vessels	Skiffs	Flat Bottom	Boston whaler	0.034	0.04	22	
		V-hull	Std. Configuration.	0.030	0.08	15	
			Swamped	0.017	0.00	15	
	Sport Boats	Cuddy Cabin	Modified V-hull	0.069	-0.08	19	
Sport Fisher	Center Console	Open cockpit	0.060	-0.09	22		
Power Vessels	Commercial Fishing Vessels	Sampans		0.037	0.02	48	
			Side-stern Trawler		0.040	0.00	48
			Longliners		0.042	0.00	48
			Junk		0.037	0.00	48
		Gill-netter	w/rear reel	0.027	0.10	48	
	Coastal Freighter			0.040	0.01	33	
Boating Debris	F/V debris			0.028	0.00	48	
	Bait/wharf box holds a cubic meter of ice	lightly loaded		0.020	0.00	10	
		fully loaded		0.013	0.27	31	
				0.026	0.18	15	
			0.016	0.16	33		

Table D-5:1 Leeway Speed and Direction Values for Drift Objects (kt)

Leeway Target Class				Leeway Speed		Divergence	
Secondary Leeway Descriptors	Capacity Modifier	Drogue Modifier	Loading Modifier	Multiplier	Modifier (Kts)	Angle (Deg)	
Maritime Life Rafts with Deep Ballast Systems and Canopies	4-6 person capacity			0.029	0.04	15	
		without drogue		0.038	-0.04	15	
			light loading	0.038	-0.04	15	
			heavy loading	0.036	-0.03	15	
		with drogue		0.018	0.03	12	
			light loading	0.016	0.05	24	
	heavy loading		0.021	0.00	20		
	15-25 person capacity			0.036	-0.09	10	
		without drogue	light loading	0.039	-0.06	9	
		with drogue	heavy loading	0.031	-0.07	9	
	Capsized				0.009	0.00	12
	Swamped				0.010	-0.04	8

Table D-5:2 Sub-Table for Maritime Life Rafts with Deep Ballast Systems and Canopies (kt)

Notes:

1. These tables are adapted from Allen and Plourde 1999 Review of Leeway: Field Experiments and Implementation. USCG Research and Development Centre Report No CG-D-08-99.
2. Prior to the publication of the data the USCG Research and Development Centre made the decision that the only data published would be data that was based on actual results derived from documented research and observation during controlled field experiments. However it has been recognised that some anomalies exist in the data pertaining to maritime life rafts with no ballast systems. There had been significant time between the initial research done by Hufford and Broida in 1974 and later research by Nash and Willcox in 1991. Also it is probable that the make of life raft used for the experiments may no longer be in use.
3. SMCs should evaluate the calculated results obtained from using the tables with actual known conditions and adjust leeway values as appropriate.

Taxonomy Class Definitions/Descriptions

The following section provides information about each of the leeway drift objects in Table D-5:1. For each description, the target characteristics are summarised and pictures are provided where available. These target descriptions are in no way meant to be all-inclusive. They are intended to assist a search planner in target identification. Proper identification will make the application of more specific leeway values possible. Some categories in Table D-5:1 do not require further explanation and therefore descriptions/pictures are not included. The SAR planner should also be reminded that any classification system will have overlap between some categories. In these cases, a decision must be made about the most probable situation.

- a) Person-in-Water (PIW)
 - b) Persons in the water including persons without any floatation, and those with a throwable cushion, with a PFD, in an anti-exposure suit and in survival/immersion suits
- i) Vertical
- Generally requires a conscious and active PIW to maintain this position. PIWs wearing a sport/work vest, anti-exposure suit, or float coat or having no floatation must actively maintain a vertical position in the water or become victims in the horizontal position.
- ii) Sitting

Appendices

The classic foetal position with legs drawn up and arms huddled across the PFD. This is the preferred position a conscious or unconscious person assumes, especially in cold water, when wearing offshore lifejackets, horse-collar lifejackets, or inflatable vests. A conscious PIW hanging onto a throwable device will also assume the sitting position until he become unconscious at which time he become a victim.

iii) Horizontal

Three separate configurations place the PIW in a horizontal position. A conscious or unconscious PIW wearing a survival suit will float flat on his back. A PIW in scuba gear, with an inflated buoyancy vest, will float in a semi-reclined position. The classic floating position of a victim is floating face down in the water.

c) Maritime Survival Craft

This section includes life rafts, lifeboats, and life capsules as illustrated at Figure D-5:2. It does not include dinghies or inflatable boats that may be carried for the same purpose.

i) Maritime Life Rafts

If there is any question about what type of life raft a vessel may carry, a phone call to life raft repair and repackaging facilities close to the homeport of the distressed vessel may provide ballast, canopy, size, and drogue information.

ii) Shallow Ballast

Consists of a series of fabric pockets generally four (4) inches in diameter and less than six inches in depth.

iii) Deep Ballast

Consist of large fabric bags, from three (3)–seven (7) on the raft, that are at least 1'x 2' x 2'.

d) Other Maritime Survival Craft

i) Life Capsule

Fully enclosed crafts commonly used on large merchant and military vessels.

e) Aviation Life Rafts

Fall basically into two groups, life rafts and slide rafts. Aviation life rafts are similar to marine life rafts, but are usually made from lighter materials.

i) Evacuation/Slide

Slide rafts are specifically designed devices intended to ease evacuation from an aircraft. They mount to doorframes or near wing emergency exits and are cut loose from the airframe once fully loaded.

f) Person-Powered Craft

This description includes all forms of rowed or paddled boats including rowboats, inflatable boats without motors, canoes, kayaks, stand up paddle boards, surfboards and windsurfers.

For examples, see Figure D-5:3.

f) Mono-hull Sailing Vessel

It is assumed that all targets in this category are adrift; therefore sails are down or missing and the crew is unable to manoeuvre the vessel at all. A class of small to medium sized sailing vessels generally less than 20 ft and never more than 30 ft in length, they are typically designed for a single purpose such as racing or day sailing.

i) Full Keel

Small to medium sized sailboats whose keel runs the full length or nearly the full length of the hull. While the forward portion of the keel is modified or eliminated on some full keel sailboats, the keel on all full keel sailboats extends aft to the rudder. This is an old hull design and is not commonly used in new hull construction due to the relatively slow sailing speeds of this hull design.

ii) Fin Keel

Small to medium sized sailboats with permanent keel skegs that do not extend aft to the rudder.

g) Skiffs

Open boats less than 20 ft long that use an outboard motor as the primary source of propulsion. Some have characteristics identical to rowed boats with the exception that an outboard motor has been attached to the stern. This group includes, but is not limited to, tenders for larger vessels, bass boats, hunting boats, Jon boats, and a large category of utility boats. Skiffs are usually found on lakes and rivers, but are also common in the calm waters of many bays and rivers that provide access to the open ocean.

h) Personal Water Craft

Include a number of different designs for one or more persons. Generally there are stand up models and ride on models. Some craft marketed as PWC closely resemble small sport boats. Most PWC's have water jet propulsion. No leeway drift experiments have yet been performed on PWC's and they do not appear within Table D-5-1. Leeway category choice should be based on number of passengers/loading, size of PWC (draft, length, freeboard) of PWC. These factors may be comparable (not exactly) to several other leeway targets.

i) Sport Boats

Includes pleasure craft from 15 to 28 feet long with beamwidths from roughly 6 to 9 feet.

They include metal, fibreglass, and wood vessels with a V, modified-V, or deep-V hull form. Sport boats can be outfitted with inboard, outboard, or I/O propulsion. This category includes side console (closed bow and bow riders) and cuddy cabin boats. (Figure D-5:8)

j) Sport Fisher

Include pleasure and commercial craft from 17 to approximately 100 feet long with beam widths up to 24 ft. The majority are between 30 and 50 ft long, with beam widths between 10 and 15 ft. This class includes both semi-displacement and planning hull forms that can be outfitted with inboard, outboard, or I/O propulsion. This category includes boats with simple centre console or walk-round cabin. Convertibles are sport fishers with a walk around cabin and flying bridge. Convertibles designed for offshore fishing may also have a spotting tower. Many convertibles provide extended cruising capabilities similar to sport cruisers, but their after deck design provides a larger open area to work fishing gear. Some of these vessels can also be found in the cruiser or motor yacht categories. (Figure D-5:9)

k) Multi-hulled vessels

Multi-hulled vessels; these vessels differ from monohulls in that they have either two similar sized parallel hulls or a larger centre hull with two smaller ones on either beam. These vessels range in size from small hobby vessels of 4-5m in length to ferries and tourist vessels. All but the smallest have living quarters in the hulls and possible on the deck that joins them. They can be sail or motor driven, or a combination of both. There is no current separate category in the leeway tables for vessels of this style. (Figure D-5:10)

l) Commercial Fishing Vessels

Include vessels from 45 to 100 feet long designed for fishing or shell fishing in coastal and ocean waters. They include side and stern trawling rigs, long liners, bottom dragging rigs, and purse seiners.

Appendices

Pole fishers are simply modified use of a sport fisher or sport cruiser and should be treated as such. Commercial fishers can be working alone, as paired vessels, or can be the mother ship to a group of smaller fishing skiffs. These vessels have different design features based on their purpose, but all have some form of deckhouse and an open area from which nets can lines are worked. A deck winch and boom system is commonly used to handle nets or lines. (Figure D-5:11)

m) Coastal Freighter

Include a wide range of commercial shipping platforms up to 100 feet in length. These vessels transfer cargo from one port to another, and shipping agents can provide estimated voyage schedules. Coastal freighters include vessels with a deckhouse on the forecastle, a midships deckhouse (common to cargo vessels), and an aft deckhouse (common to tankers and container ships). Leeway of these vessels will of course not only vary with respect to deckhouse location; it will also be greatly affected by loading, amount, and type of cargo. (Figure D-5:12)

n) Boating Debris

Includes any debris that can be expected from a boat that is sinking and/or breaking up. It may include paper or plastic containers, bedding or clothing, and a variety of fragmented boat sections.

i) Fishing Debris

Debris typical to a fishing vessel such as lifejacket, life ring, fishing float balls, a fishing box lid, or wooden boards

ii) Bait/Wharf Box

Commercially available 1.1 X 1.5 metre plastic box used by commercial fisherman for holding ice and/or fish. Although not it's intended use, it could also serve as a floatation/life raft by persons in distress.

- Lightly loaded. Approximately 200 lbs. (simulation of one person)
- Fully loaded. Approximately 800 lbs. (simulation of four persons)

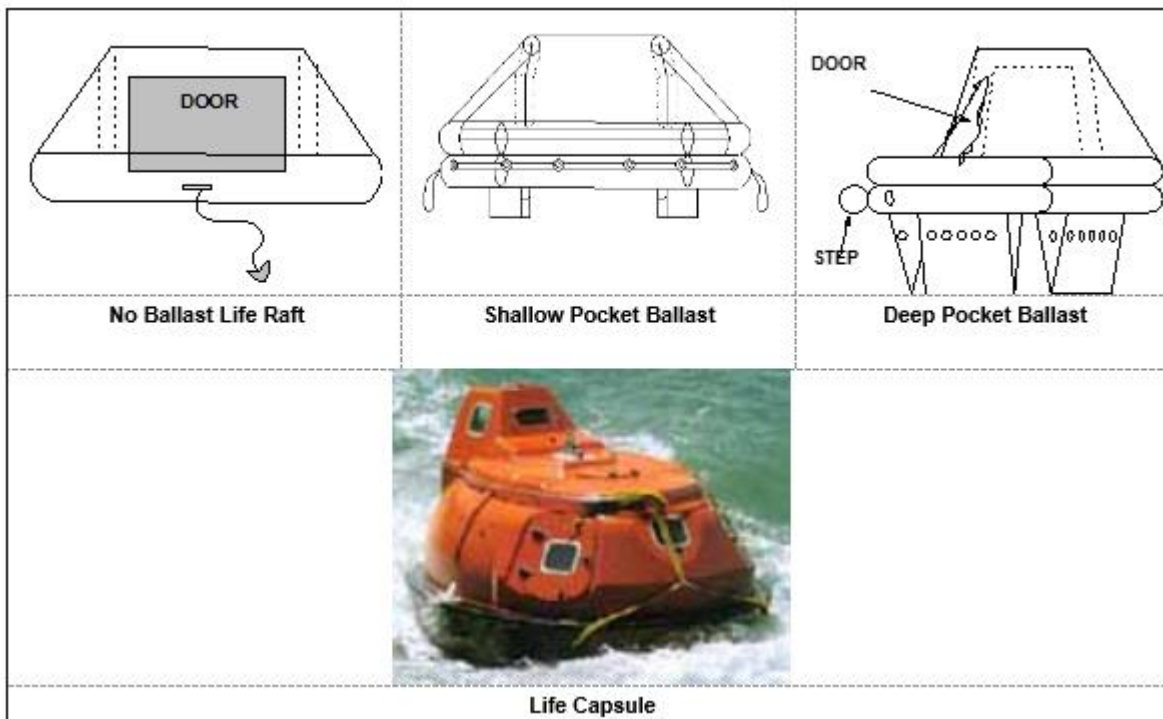

Figure D-5:2 Maritime Survival Craft



Figure D-5:3 Person-Powered Craft

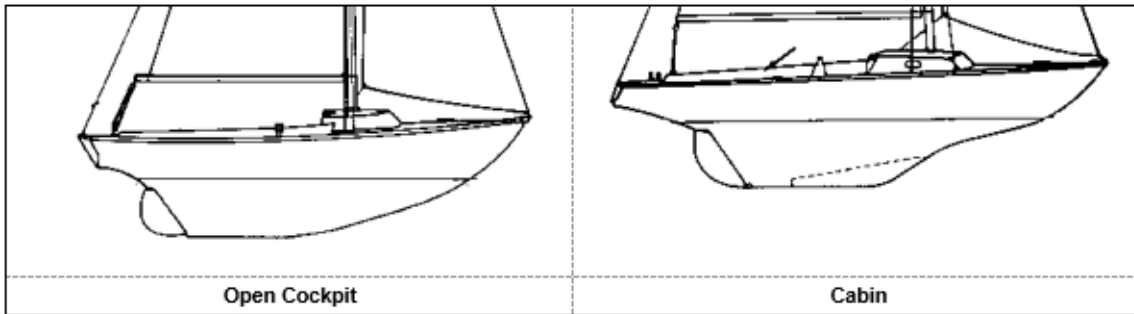

Figure D-5:4 Full Keel One Design Sailboat

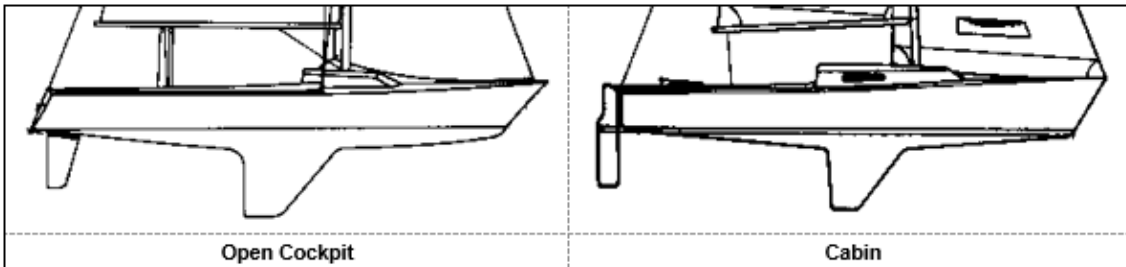

Figure D-5:5 22 Dagger Keel One-Design Sailboat



Figure D-5:6 Skiffs

Appendices



Figure D-5-7 Personal Water Craft

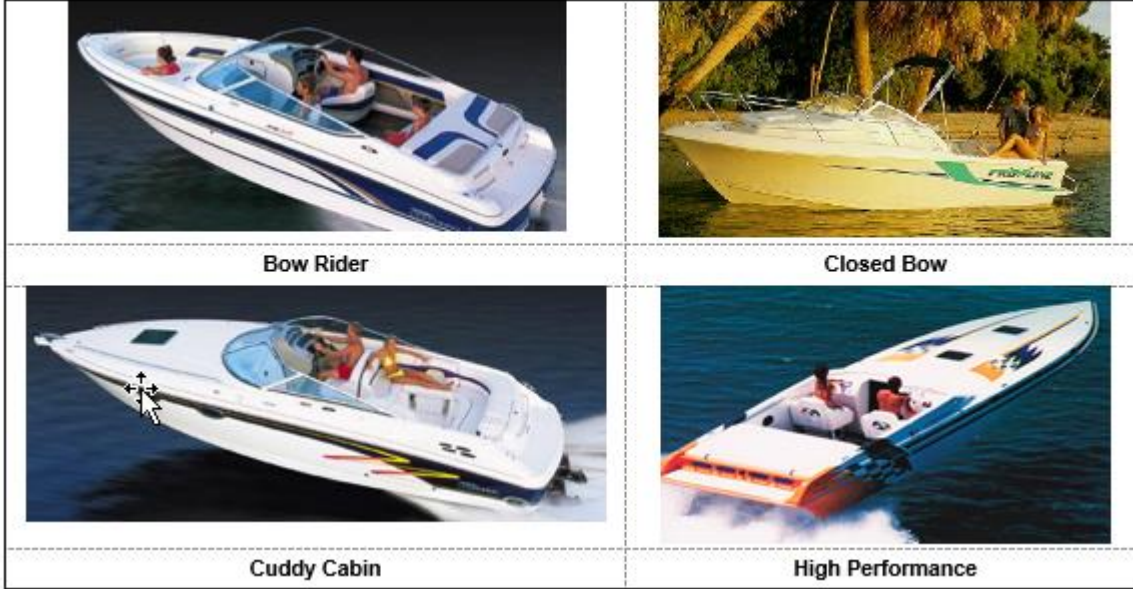

Figure D-5:8 Sports Boats



Figure D-5:9 Sport Fishers



Figure D-5:10 Multi-hulled vessels

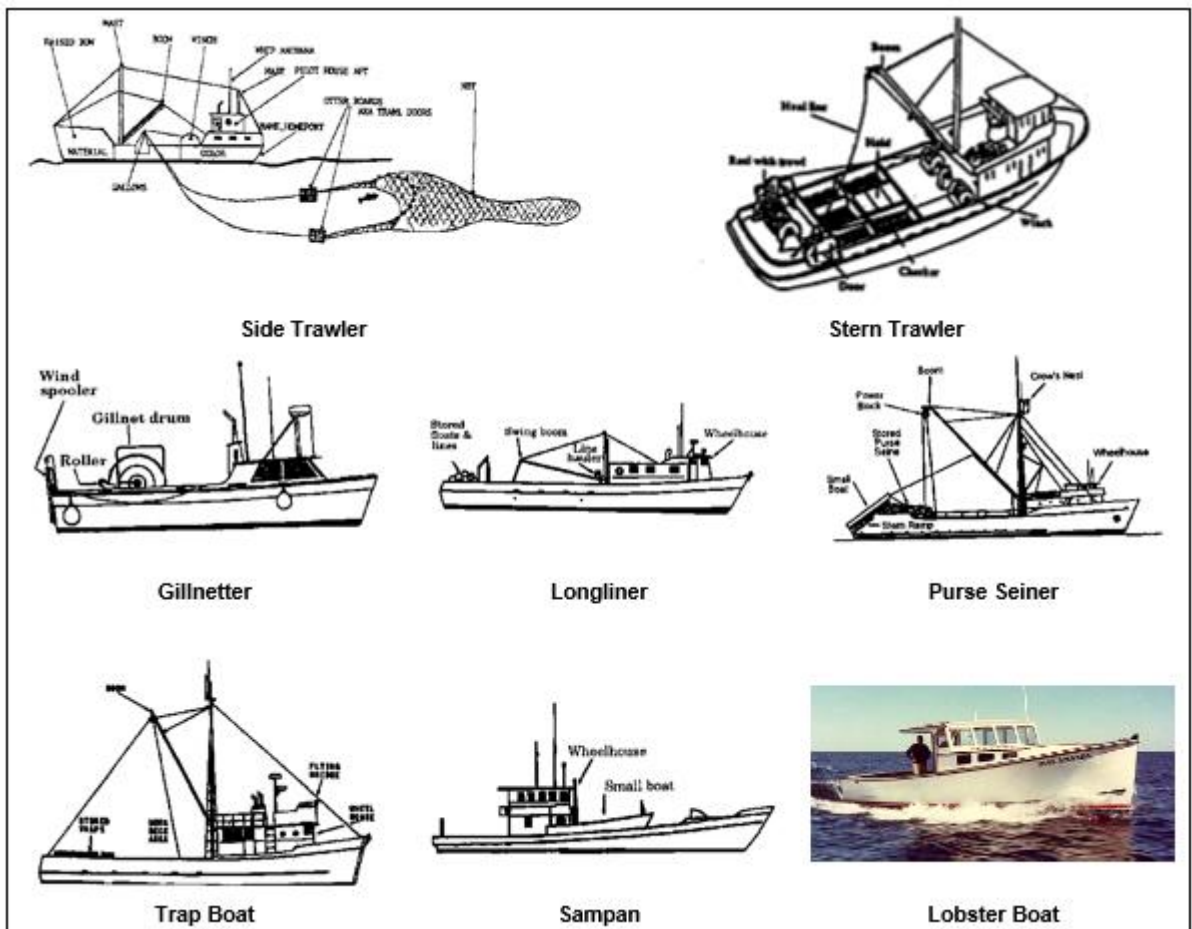
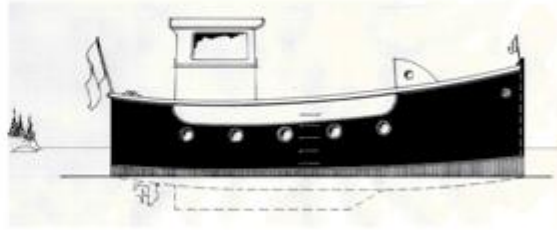

Figure D-5:11 Commercial Fishers

Appendices



Coastal Freighter with Mid Deckhouse



Coastal Freighter with Aft Deckhouse

Figure D-5:12 Coastal Freighters

Probability of Detection

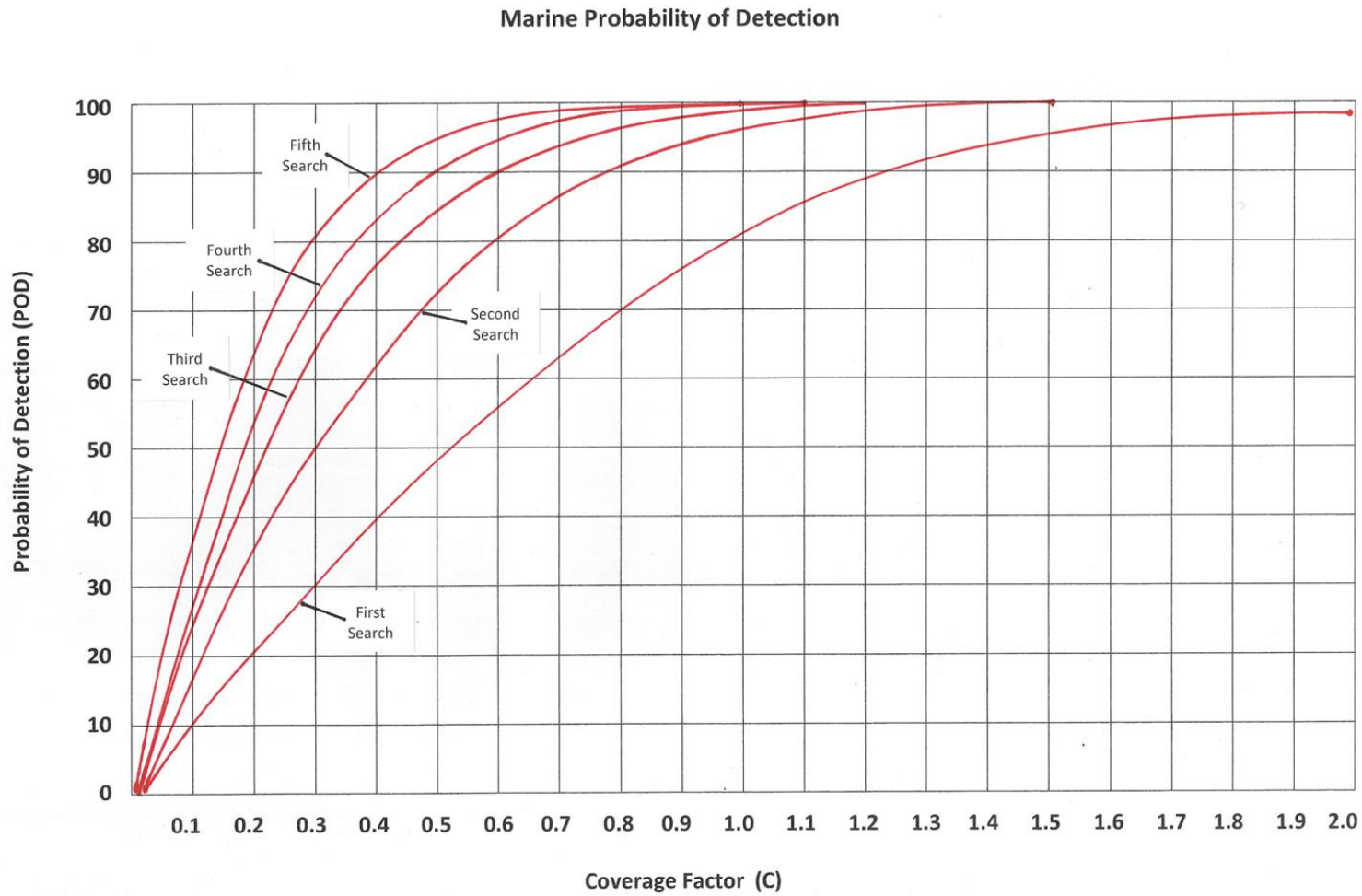

Figure D-5:13 Probability of Detection

Appendices

Sweep Width Tables for Visual Search over Water

SEARCH OBJECT	Height of eye 8'						Height of eye 14'					
	Visibility in kilometres/nm						Visibility in kilometres/nm					
	2/ 1.1	5/ 2.7	10/ 5.4	15/ 8.1	20/ 10.8	>25/ 13.5	2/ 1.1	5/ 2.7	10/ 5.4	15/ 8.1	20/ 10.8	>25/ 13.5
Person in water	0.2	0.2	0.3	0.3	0.3	0.3	0.3	0.4	0.5	0.6	0.6	0.6
Raft 1 Person	0.7	1.2	1.8	2.1	2.4	2.5	1.0	1.6	2.5	2.9	3.2	3.3
Raft 4 Person	0.8	1.5	2.3	2.9	3.2	3.4	1.1	2.0	3.1	3.8	4.2	4.4
Raft 6 Person	0.9	1.7	2.7	3.4	3.8	4.1	1.2	2.2	3.5	4.4	5.0	5.3
Raft 8 Person	0.9	1.7	2.8	3.5	4.0	4.2	1.2	2.3	3.6	4.5	5.1	5.4
Raft 10 person	0.9	1.8	2.9	3.7	4.2	4.6	1.2	2.3	3.7	4.7	5.4	5.8
Raft 15 Person	1.0	2.0	3.2	4.0	4.5	4.9	1.2	2.5	4.0	5.1	5.7	6.2
Raft 20 Person	1.0	2.1	3.5	4.4	5.1	5.6	1.3	2.6	4.3	5.7	6.4	6.9
Raft 25 Person	1.0	2.2	3.7	4.7	5.5	6.0	1.3	2.7	4.3	5.8	6.7	7.5
Power Boat <5m (15 ft)	0.5	0.7	1.0	1.2	1.3	1.4	0.5	1.0	1.5	1.8	1.9	2.0
Power Boat 5-8m (15-25 ft)	0.8	1.4	2.3	2.9	3.4	3.8	1.0	1.9	3.0	3.9	4.5	5.0
Power Boat 8-12m (25-40 ft)	0.8	1.8	3.1	4.1	4.9	5.6	1.2	2.3	4.0	5.3	6.4	7.3
Power Boat 12-20m (40-65 ft)	0.9	2.2	4.2	5.9	7.4	8.7	1.2	3.0	5.4	7.6	9.6	11.3
Power Boat 20-27m (65-90 ft)	0.9	2.3	4.6	6.8	8.8	10.6	1.2	3.0	6.0	8.7	11.3	13.6
Sail Boat 5m (15 ft)	0.8	1.4	2.2	2.7	3.1	3.4	1.0	1.8	2.8	3.5	4.1	4.5
Sail Boat 6m (20 ft)	0.8	1.6	2.6	3.3	3.9	4.4	1.1	2.0	3.3	4.3	5.0	5.6
Sail Boat 8m (25 ft)	0.9	1.8	2.9	3.9	4.6	5.1	1.1	2.2	3.8	5.0	5.9	6.7
Sail Boat 9m (30 ft)	0.9	2.0	3.4	4.6	5.5	6.3	1.2	2.5	4.4	5.9	7.1	8.1
Sail Boat 12m (40 ft)	0.9	2.2	4.1	5.7	7.0	8.1	1.3	2.8	5.2	7.2	9.0	10.5
Sail Boat 15m (50 ft)	0.9	2.2	4.3	6.1	7.7	9.1	1.2	2.9	5.2	7.9	9.9	11.7
Sail Boat 20-23m (65-75 ft)	0.9	2.3	4.5	6.5	8.3	9.9	1.2	3.0	5.8	8.4	10.8	12.9
Sail Boat 23-27m (75-90 ft)	0.9	2.4	4.7	6.8	8.9	10.7	1.2	3.1	6.1	8.9	11.5	13.8

Table D-5:3 Uncorrected Visual Sweep Width for Vessels and Small Boats (NM)

Note: A sailboat is only a sailboat if the sails are up. If the sails are down, the craft should be classed as a powerboat.

Weather Correction Factors for all Types of Search Facilities

Weather: Winds km/h (kt) or seas m (ft)	Search Object	
	Person in water, raft or boat <10m (33ft)	Other search objects
Winds <28km/h (<15kts) or seas 0-1m (0-3ft)	1.0	1.0
Winds 28-46km/h (15-25kts) or seas 1-1.5m (3-5ft)	0.5	0.8
Winds >46km/h (>25kts) or seas >1.5m (>5ft)	0.25	0.5

Table D-5:4 Weather Correction Factors for all Types of Search Facilities

Note: This table differs from IAMSAR for other search objects in winds greater than 15kts. This is based on previous values used and observations of the reported effects of high winds on sweep width values in actual SAR incidents.

Uncorrected Visual Sweep Widths for Merchant Ships (NM)

Height of eye correlates to bridge of a merchant ship	Meteorological visibility [km]				
	5 km	10 km	20 km	30 km	40 km
Search Object					
Person in water	0.4	0.5	0.6	0.7	0.7
4-person life raft	2.3	3.2	4.2	4.9	5.5
6-person life raft	2.5	3.6	5.0	6.2	6.9
15-person life raft	2.6	4.0	5.1	6.4	7.3
25-person life raft	2.7	4.2	5.2	6.5	7.5
Boat <5m (17ft)	1.1	1.4	1.9	2.1	2.3
Boat <7m (23ft)	2.0	2.9	4.3	5.2	5.8
Boat <12m (40ft)	2.8	4.5	7.6	9.4	11.6
Boat <24m (79ft)	3.2	5.6	10.7	14.7	18.1

Table D-5:5 Uncorrected Visual Sweep Widths for Merchant Ships (NM)

Uncorrected Sweep Widths for Fixed-Wing Aircraft (NM) at 500 ft and 1000 ft

Search Object	Altitude 500ft						Altitude 1000ft					
	Visibility km/NM						Visibility km/NM					
	2/ 1.1	5/ 2.7	10/ 5.4	20/ 10.8	30/ 16.2	>40/ 21.6	2/ 1.1	5/ 2.7	10/ 5.4	20/ 10.8	30/ 16.2	>40/ 21.6
Person in water	0.0	0.1	0.1	0.1	0.1	0.1	0.0	0.1	0.1	0.1	0.1	0.1
Raft 1 person	0.3	0.7	0.9	1.2	1.4	1.4	0.3	0.7	0.9	1.2	1.4	1.4
Raft 4 Person	0.4	1.0	1.3	1.8	2.0	2.2	0.3	1.0	1.3	1.8	2.1	2.3
Raft 6 Person	0.4	1.1	1.5	2.2	2.5	2.8	0.4	1.1	1.6	2.2	2.6	2.8
Raft 8 Person	0.4	1.2	1.6	2.3	2.7	2.9	0.4	1.2	1.7	2.4	2.8	3.0
Raft 10 Person	0.4	1.2	1.7	2.5	2.9	3.2	0.4	1.3	1.8	2.6	3.0	3.3
Raft 15 Person	0.5	1.3	1.9	2.7	3.3	3.6	0.4	1.4	2.0	2.8	3.4	3.7
Raft 20 Person	0.5	1.5	2.1	3.2	3.8	4.2	0.4	1.5	2.2	3.2	3.9	4.3
Raft 25 Person	0.5	1.6	2.3	3.4	4.1	4.6	0.4	1.6	2.3	3.5	4.2	4.7
Power Boat <5m (15ft)	0.4	0.9	1.2	1.5	1.7	1.8	0.4	1.0	1.3	1.7	1.8	2.0
Power Boat 5-8m (15-25ft)	0.5	1.7	2.4	3.6	4.3	4.8	0.5	1.7	2.5	3.7	4.4	5.0
Power Boat 8-12m (25-40ft)	0.6	2.1	3.3	5.3	6.7	7.7	0.5	2.2	3.4	5.4	6.8	7.8
Power Boat 12-20m (40-65ft)	0.6	2.7	4.5	8.1	10.9	13.1	0.6	2.7	4.5	8.2	10.9	13.1
Power Boat 20-27m (65-90ft)	0.6	2.8	5.0	9.8	13.5	16.7	0.6	2.8	5.1	9.8	13.6	16.7
Sail Boat 5m (15ft)	0.5	1.6	2.2	3.2	3.9	4.3	0.5	1.6	2.3	3.3	4.0	4.4
Sail Boat 8m (25ft)	0.6	2.0	3.1	4.9	6.1	7.0	0.5	2.1	3.2	5.0	6.2	7.1
Sail Boat 12m (40ft)	0.6	2.6	4.3	7.6	10.0	11.9	0.6	2.6	4.3	7.6	10.9	12.0
Sail Boat 15m (50ft)	0.8	2.7	4.6	8.4	11.3	13.7	0.6	2.7	4.6	8.5	11.4	13.7
Sail Boat 20-23m (65-75ft)	0.6	2.8	4.9	9.3	12.7	15.5	0.6	2.8	4.9	9.3	12.8	15.6
Sail Boat 23-27m (75-90ft)	0.6	2.8	5.1	9.9	13.7	17.0	0.6	2.8	5.1	9.9	13.6	17.0
Ship 27-46m (90-150ft)	0.6	2.9	5.4	11.1	15.9	20.1	0.6	2.9	5.4	11.1	15.9	20.1
Ship 46-91m (150-300ft)	0.6	3.0	5.7	12.5	18.9	24.7	0.6	3.0	5.7	12.5	18.9	24.7
Ship >91m (>300ft)	0.7	3.0	5.8	13.2	20.6	27.9	0.6	3.0	5.8	13.2	20.6	27.9

Table D-5:6 (1) Uncorrected Sweep Widths for Fixed-Wing Aircraft (NM) at 500 ft and 1000 ft

Notes:

1. For search altitudes of 500 feet only, the sweep width values for a person in water may be multiplied by four (4), if it is known that the person is wearing a flotation device.
2. A sailboat is only a sailboat if the sails are up. If the sails are down, the craft should be classed as a powerboat.

Weather Correction Factors for all Types of Search Facilities

Weather: Winds km/h (kt) or seas m (ft)	Search Object	
	Person in water, raft or boat <10m (33ft)	Other search objects
Winds <28km/h (<15kts) or seas 0-1m (0-3ft)	1.0	1.0
Winds 28-46km/h (15-25kts) or seas 1-1.5m (3-5ft)	0.5	0.8
Winds >46km/h (>25kts) or seas >1.5m (>5ft)	0.25	0.5

Table D-5:4 Weather Correction Factors for all Types of Search Facilities

Note: This table differs from IAMSAR for other search objects in winds greater than 15kts. This is based on previous values used and observations of the reported effects of high winds on sweep width values in actual SAR incidents.

Uncorrected Sweep Widths for Fixed-Wing Aircraft (NM) at 1500 ft and 2000 ft

Search Object [Metres (ft)]	Altitude 1500 ft						Altitude 2000 ft					
	Visibility [km]						Visibility [km]					
	2	5	10	20	30	>40	2	5	10	20	30	>40
Person in Water	0.0	0.0	0.0	0.0	0.0	0.1	0.0	0.0	0.0	0.0	0.0	0.0
Raft 1 person	0.2	0.7	0.9	1.3	1.4	1.4	0.1	0.6	0.9	1.2	1.4	1.4
Raft 4 person	0.3	1.0	1.3	1.9	2.1	2.3	0.2	0.9	1.3	1.9	2.2	2.3
Raft 6 person	0.3	1.1	1.6	2.3	2.6	2.9	0.2	1.1	1.6	2.3	2.7	2.9
Raft 8 person	0.3	1.2	1.7	2.4	2.8	3.1	0.2	1.2	1.7	2.5	2.9	3.2
Raft 10 person	0.3	1.3	1.8	2.6	3.1	3.4	0.2	1.2	1.8	2.7	3.1	3.5
Raft 15 person	0.3	1.4	2.0	2.9	3.4	3.8	0.2	1.4	2.0	3.0	3.5	3.9
Raft 20 person	0.4	1.5	2.2	3.3	4.0	4.4	0.4	1.5	2.2	3.4	4.0	4.5
Raft 25 person	0.4	1.6	2.4	3.6	4.3	4.8	0.3	1.6	2.4	3.6	4.4	4.9
Power Boat <5 (15 ft)	0.3	1.0	1.3	1.7	2.0	2.1	0.2	1.0	1.3	1.8	2.0	2.2
Power Boat 6 (20 ft)	0.4	1.7	2.5	3.7	4.5	5.1	0.3	1.7	2.5	3.8	4.6	5.1
Power Boat 10 (33 ft)	0.5	2.2	3.4	5.5	6.8	7.9	0.3	2.2	3.4	5.5	6.9	8.0
Power Boat 16 (53 ft)	0.5	2.6	4.5	8.2	11.0	13.2	0.4	2.6	4.5	8.3	11.0	13.3
Power Boat 24 (78 ft)	0.5	2.8	5.1	9.8	13.6	16.7	0.4	2.8	5.0	9.8	13.6	16.8
Sail Boat 5 (15 ft)	0.4	1.6	2.3	3.4	4.1	4.5	0.3	1.6	2.3	3.5	4.1	4.5
Sail Boat 8 (26 ft)	0.5	2.1	3.2	5.1	6.3	7.2	0.3	2.1	3.3	5.2	6.4	7.3
Sail Boat 12 (39 ft)	0.5	2.6	4.3	7.6	10.1	12.0	0.4	2.5	4.3	7.7	10.1	12.1
Sail Boat 15 (49 ft)	0.5	2.7	4.6	8.5	11.4	13.8	0.4	2.7	4.6	8.6	11.5	13.9
Sail Boat 21 (69 ft)	0.5	2.8	4.9	9.4	12.8	15.7	0.4	2.7	4.9	9.4	12.9	15.7
Sail Boat 25 (83 ft)	0.5	2.8	5.1	10.0	13.8	17.1	0.4	2.8	5.1	10.0	13.9	17.1
Ship 27-46 (90-150 ft)	0.5	2.9	5.4	11.1	16.0	20.1	0.4	2.9	5.4	11.1	16.0	20.1
Ship 46-91 (150-300 ft)	0.5	3.0	5.7	12.5	18.9	24.7	0.4	3.0	5.7	12.5	18.9	24.7
Ship > 91 (>300 ft)	0.6	3.0	5.8	13.2	20.7	27.9	0.5	3.0	5.8	13.2	20.6	27.9

Table D-5:6 (2) Uncorrected Sweep Widths for Fixed-Wing Aircraft (NM) at 1500 ft and 2000 ft

Note:

1. For search altitudes of 500 feet only, the sweep width values for a person in water may be multiplied by 4, if it is known that the person is wearing a flotation device.
2. A sailboat is only a sailboat if the sails are up. If the sails are down, the craft should be classed as a powerboat.

Weather Correction Factors for all Types of Search Facilities

Weather: Winds km/h (kt) or seas m (ft)	Search Object	
	Person in water, raft or boat <10m (33ft)	Other search objects
Winds <28km/h (<15kts) or seas 0-1m (0-3ft)	1.0	1.0
Winds 28-46km/h (15-25kts) or seas 1-1.5m (3-5ft)	0.5	0.8
Winds >46km/h (>25kts) or seas >1.5m (>5ft)	0.25	0.5

Table D-5:4 Weather Correction Factors for all Types of Search Facilities

Note: This table differs from IAMSAR for other search objects in winds greater than 15kts. This is based on previous values used and observations of the reported effects of high winds on sweep width values in actual SAR incidents.

Uncorrected Sweep Widths for Helicopters (NM) – Maritime 500 ft and 1000 ft

Search Object [Metres (ft)]	Altitude 500 ft						Altitude 1000 ft					
	Visibility [km]						Visibility [km]					
	2	5	10	20	30	>40	2	5	10	20	30	>40
Person in Water	0.0	0.1	0.1	0.1	0.1	0.1	0.0	0.1	0.1	0.1	0.1	0.1
Raft 1 person	0.4	0.9	1.2	1.6	1.8	1.8	0.4	0.9	1.2	1.6	1.8	1.8
Raft 4 person	0.5	1.2	1.6	2.2	2.6	2.8	0.5	1.2	1.7	2.3	2.6	2.9
Raft 6 person	0.5	1.4	1.9	2.7	3.2	3.5	0.5	1.4	2.0	2.8	3.2	3.5
Raft 8 person	0.6	1.5	2.0	2.8	3.3	3.7	0.5	1.5	2.1	2.9	3.4	3.8
Raft 10 person	0.6	1.6	2.2	3.1	3.6	4.0	0.5	1.6	2.2	3.2	3.7	4.1
Raft 15 person	0.6	1.7	2.3	3.3	4.0	4.4	0.6	1.7	2.4	3.5	4.1	4.5
Raft 20 person	0.6	1.8	2.6	3.8	4.6	5.1	0.6	1.8	2.7	3.9	4.7	5.2
Raft 25 person	0.6	1.9	2.7	4.1	5.0	5.6	0.6	1.9	2.8	4.2	5.1	5.7
Power Boat <5 (15 ft)	0.5	1.2	1.5	1.9	2.2	2.3	0.5	1.2	1.6	2.1	2.3	2.5
Power Boat 6 (20 ft)	0.7	2.0	2.9	4.3	5.2	5.8	0.7	2.1	3.0	4.4	5.3	5.9
Power Boat 10 (33 ft)	0.8	2.5	3.9	6.2	7.8	9.0	0.7	2.6	3.9	6.3	7.9	9.1
Power Boat 16 (53 ft)	0.8	3.1	5.1	9.2	12.3	14.7	0.7	3.1	5.2	9.2	12.3	14.8
Power Boat 24 (78 ft)	0.8	3.3	5.7	10.8	15.0	18.4	0.8	3.3	5.7	10.9	15.0	18.5
Sail Boat 5 (15 ft)	0.7	1.9	2.7	3.9	4.7	5.2	0.6	1.9	2.8	4.0	4.8	5.4
Sail Boat 8 (26 ft)	0.8	2.4	3.7	5.7	7.1	8.2	0.7	2.5	3.7	5.8	7.3	8.3
Sail Boat 12 (39 ft)	0.8	3.0	4.9	8.3	11.3	13.5	0.7	3.0	4.9	8.6	11.4	13.5
Sail Boat 15 (49 ft)	0.8	3.1	5.2	9.5	12.7	15.3	0.7	3.1	5.3	9.5	12.8	15.4
Sail Boat 21 (69 ft)	0.8	3.2	5.5	10.4	14.1	17.3	0.8	3.2	5.6	10.4	14.2	17.3
Sail Boat 25 (83 ft)	0.8	3.3	5.7	11.0	15.2	18.7	0.8	3.3	5.7	11.0	15.3	18.8
Ship 27-46 (90-150 ft)	0.8	3.4	6.0	12.2	17.4	21.9	0.8	3.4	6.0	12.2	17.4	21.9
Ship 46-91 (150-300ft)	0.8	3.4	6.3	13.6	20.4	26.6	0.8	3.4	6.3	13.6	20.4	26.6
Ship > 91 (>300 ft)	0.8	3.5	6.4	14.3	22.1	29.8	0.8	3.5	6.4	14.3	22.2	29.8

Table D-5:7 (1) Uncorrected Sweep Widths for Helicopters (NM) – Maritime 500 ft and 1000 ft

Notes:

1. For search altitudes of 500 feet only, the sweep width values for a person in water may be multiplied by four (4), if it is known that the person is wearing a flotation device.
2. A sailboat is only a sailboat if the sails are up. If the sails are down, the craft should be classed as a powerboat.

Weather correction factors for all types of search facilities

Weather: winds km/h (kt) or seas m (ft)	Search Object	
	Person in water, raft or boat < 10m (33ft)	Other search objects
Winds <28 km/h (<15 kt) or seas 0-1 m (0-3ft)	1.0	1.0
Winds 28-46 km/h (15-25 kt) or seas 1-1.5 m (3-5ft)	0.5	0.8
Winds >46 km/h (> 25 kt) or seas > 1.5 m (> 5ft)	0.25	0.5

Table D-5:4 Weather Correction Factors for all Types of Search Facilities

Note: This table differs from IAMSAR for other search objects in winds greater than 15kts. This is based on previous values used and observations of the reported effects of high winds on sweep width values in actual SAR incidents.

Uncorrected Sweep Widths for Helicopters (NM) - Maritime 1500 ft and 2000 ft

Search Object [Metres (ft)]	Altitude 1500 ft						Altitude 2000 ft					
	Visibility [km]						Visibility [km]					
	2	5	10	20	30	>40	2	5	10	20	30	>40
Person in Water	0.0	0.0	0.0	0.1	0.1	0.1	0.0	0.0	0.0	0.0	0.0	0.1
Raft 1 person	0.3	0.9	1.2	1.6	1.8	1.8	0.2	0.8	1.2	1.6	1.8	1.8
Raft 4 person	0.4	1.2	1.7	2.3	2.7	2.9	0.3	1.2	1.7	2.3	2.7	3.0
Raft 6 person	0.4	1.4	2.0	2.8	3.3	3.6	0.3	1.4	2.0	2.8	3.3	3.6
Raft 8 person	0.4	1.5	2.1	3.0	3.5	3.9	0.3	1.5	2.1	3.0	3.6	3.9
Raft 10 person	0.4	1.6	2.2	3.2	3.8	4.2	0.3	1.6	2.3	3.3	3.9	4.2
Raft 15 person	0.5	1.7	2.4	3.5	4.2	4.6	0.3	1.7	2.5	3.6	4.3	4.7
Raft 20 person	0.5	1.9	2.7	4.0	4.8	5.3	0.4	1.8	2.7	4.0	4.9	5.4
Raft 25 person	0.5	2.0	2.9	4.3	5.2	5.6	0.4	1.9	2.9	4.3	5.3	5.9
Power Boat <5 (15 ft)	0.4	1.3	1.7	2.2	2.5	2.6	0.3	1.3	1.7	2.3	2.6	2.7
Power Boat 6 (20 ft)	0.6	2.1	3.0	4.5	5.4	6.1	0.4	2.1	3.0	4.5	5.5	6.1
Power Boat 10 (33 ft)	0.6	2.6	4.0	6.3	7.9	9.2	0.5	2.6	4.0	6.4	8.0	9.3
Power Boat 16 (53 ft)	0.7	3.1	5.2	9.3	12.4	14.8	0.5	3.0	5.2	9.3	12.4	14.9
Power Boat 24 (78 ft)	0.7	3.2	5.7	10.9	15.1	18.5	0.5	3.2	5.7	10.9	15.1	18.5
Sail Boat 5 (15 ft)	0.6	2.0	2.8	4.1	4.9	5.5	0.4	1.9	2.8	4.2	5.0	5.6
Sail Boat 8 (26 ft)	0.6	2.5	3.8	5.9	7.4	8.4	0.5	2.5	3.8	6.0	7.5	8.6
Sail Boat 12 (39 ft)	0.6	3.0	4.9	8.7	11.4	13.6	0.5	3.0	4.9	8.7	11.4	13.6
Sail Boat 15 (49 ft)	0.7	3.1	5.3	9.6	12.8	15.5	0.5	3.1	5.3	9.6	12.9	15.5
Sail Boat 21 (69 ft)	0.7	3.2	5.6	10.4	14.3	17.4	0.5	3.2	5.6	10.5	14.3	17.4
Sail Boat 25 (83 ft)	0.7	3.3	5.7	11.1	15.3	18.8	0.5	3.2	5.7	11.1	15.4	18.9
Ship 27-46 (90-150 ft)	0.7	3.3	6.0	12.2	17.5	22.0	0.5	3.3	6.0	12.2	17.5	22.0
Ship 46-91 (150-300ft)	0.7	3.4	6.3	13.6	20.4	26.6	0.5	3.4	6.3	13.6	20.4	26.6
Ship > 91 (>300 ft)	0.7	3.4	6.4	14.3	22.2	29.8	0.6	3.4	6.4	14.3	22.2	29.8

Table D-5:7 (2) Uncorrected Sweep Widths for Helicopters (NM) - Maritime 1500 ft and 2000 ft

Notes:

1. For search altitudes of 500 feet only, the sweep width values for a person in water may be multiplied by four (4), if it is known that the person is wearing a flotation device.
2. A sailboat is only a sailboat if the sails are up. If the sails are down, the craft should be classed as a powerboat.

Weather correction factors for all types of search facilities

Weather: winds km/h (kt) or seas m (ft)	Search Object	
	Person in water, raft or boat < 10m (33ft)	Other search objects
Winds <28 km/h (<15 kt) or seas 0-1 m (0-3ft)	1.0	1.0
Winds 28-46 km/h (15-25 kt) or seas 1-1.5 m (3-5ft)	0.5	0.8
Winds >46 km/h (> 25 kt) or seas > 1.5 m (> 5ft)	0.25	0.5

Table D-5:4 Weather Correction Factors for all Types of Search Facilities

Note: This table differs from IAMSAR for other search objects in winds greater than 15kts. This is based on previous values used and observations of the reported effects of high winds on sweep width values in actual SAR incidents.

Fixed-wing Aircraft Search Facilities

Search Object	Fixed Wing Speed kt			Helicopter speed kt			
	< or = 150	180	210	< or = 60	90	120	140
Person in Water	1.2	1.0	0.9	1.5	1.0	0.8	0.7
Raft – 1-4 Person	1.1	1.0	0.9	1.3	1.0	0.9	0.8
Raft 6-25 Person	1.1	1.0	0.9	1.2	1.0	0.9	0.8
Power Boat - < 8m (< 25ft)	1.1	1.0	0.9	1.2	1.0	0.9	0.8
Power Boat - 10m (33ft)	1.1	1.0	0.9	1.1	1.0	0.9	0.9
Power Boat - 16m (53ft)	1.1	1.0	1.0	1.1	1.0	0.9	0.9
Power Boat - 24m (78ft)	1.1	1.0	1.0	1.1	1.0	1.0	0.9
Sail Boat - < 8m (< 25ft)	1.1	1.0	0.9	1.2	1.0	0.9	0.9
Sail Boat - 12m (39ft)	1.1	1.0	1.0	1.1	1.0	0.9	0.9
Sail Boat - 25m (83ft)	1.1	1.0	1.0	1.1	1.0	1.0	0.9
Ship – > 27m (> 90ft)	1.0	1.0	1.0	1.1	1.0	1.0	0.9

Table D-5:8 Speed (velocity) Correction Factors for Helicopter and Fixed-wing Aircraft Search Facilities

Sweep Width Tables for Visual Search Over Land

Search object	Height (ft)	Visibility [km]				
		5 km	10 km	20 km	30 km	40 km
Person	500	0.4	0.4	0.5	0.5	0.5
	1000	0.4	0.4	0.5	0.5	0.5
	1500	-	-	-	-	-
	2000	-	-	-	-	-
Vehicle	500	0.9	1.3	1.3	1.3	1.3
	1000	1.0	1.4	1.4	1.5	1.5
	1500	1.0	1.4	1.7	1.7	1.7
	2000	1.0	1.5	2.0	2.0	2.0
Aircraft less than 5700 kg	500	1.0	1.4	1.4	1.4	1.4
	1000	1.0	1.5	1.5	1.6	1.6
	1500	1.0	1.5	1.8	1.8	1.8
	2000	1.0	1.6	2.0	2.0	2.0
Aircraft over 5700 kg	500	1.2	2.0	2.2	2.2	2.2
	1000	1.8	2.7	3.0	3.0	3.0
	1500	2.0	2.8	3.2	3.2	3.2
	2000	2.2	2.9	3.5	3.5	3.5

Table D-5:9 Uncorrected Sweep Widths for Visual Land Search (NM)

Correction Factors – Vegetation and High Terrain

Search object	Less than 15% vegetation, open areas or scattered timber	15-60% vegetation or hilly; medium forest or scrub	60-85% vegetation or mountainous; dense forest or scrub	Over 85% vegetation; rain forest
Person	0.8	0.5	0.3	0.1
Vehicle	1.0	0.7	0.4	0.1
Aircraft < 5700kg	1.0	0.7	0.4	0.1
Aircraft > 5700kg	1.0	0.8	0.4	0.1

Table D-5:10 Correction Factors – Vegetation and High Terrain

Appendix D-6 Probable Errors of Position

Probable Navigation Error of the Target (x)

1. Initial Position Error (X) of the target and Search Craft Position Error (Y) are the estimated errors of position based on navigational accuracy of the target and of the search assets.

If the information on the means of navigation to be used by the target or by a search facility is available, the navigational fix errors listed in Table D-6:1 may be used for positions reported as navigational fixes.

Means of Navigation	Fix error (NM)
GPS	0.1 NM
RADAR	1 NM
Visual fix (3 lines) *	1 NM
Celestial fix (3 lines) *	2 NM
Marine Radio Beacon	4 NM (3 beacon fix)
INS	0.5 NM per flight hour without update
VOR	+ or - 3 DEG arc and 3% of distance or 0.5 NM radius, whichever is greater
TACAN	+ or - 3 DEG arc and 3% of distance or 0.5 NM radius, whichever is greater

Table D-6:1 Navigational Fixed Errors

* Should be evaluated upward according to circumstances

Note: Variation from IAMSAR for Tables D-6:2 & D-6:3, the National SAR Manual uses the values previously used by JRCC Australia because experience has shown it is more practicable to base fix errors on the navigation equipment carried in a craft.

2. The above values for Fix errors in Table D-6:1 are appropriate for the actual position of a target and/or search assets. An SMC should be aware that if the values in Table D-6:1, particularly that for GPS, are used to calculate a Total Probable Error of Position (E) for a Stage 3 search, particularly for a search over land or any search for an aircraft, the search area produced, because of its dimensions, may not be practical to use.
3. When designing a search area an SMC can always use his discretion, however to obtain a practical search area it is recommended that the fix errors in Tables D-6:2 & D-6:3 be utilised.
4. When the means of navigation used by the target or by a search asset is unknown or the SMC wishes to produce a practical search area for a Stage 3 search, the following Fix errors may be applied:

Type of Craft	Fix Error
Ships, military submarines	5 NM radius
Aircraft navigated by a self-contained navigation system	5 NM radius
Aircraft (other)	10 NM radius
Small craft, Submersibles	15 NM radius

Table D-6:2 Type of Craft

5. When the initially reported position of the target is based on dead reckoning (DR) or the search asset must use DR navigation, an additional error is assumed for the distance travelled since the last fix. The position error is the sum of the fix error plus the DR error (DRe) as shown in Table D-6:3.

Type of craft	DR error (DRe)
Ship, Submarine (Military)	The error of the last positive fix plus 5% of the distance from that fix
Aircraft	The error of the last positive fix plus 10% of the distance from that fix
Small craft, Submersibles	The error of the last positive fix plus 15% of the distance from that fix

Table D-6:3 Dead Reckoning (DR) Errors

6. The figures and factors shown in Tables D-6:1 to D-6:3 are minimum values and may be increased at the SMC's discretion should information be received indicating that the navigational accuracy of either the distressed or the search craft differs significantly from the accepted standard.
7. As an example, the 'x' factor for a missing aircraft with two or more engines not using a self-contained navigation system which reported at position 'A', but failed to report at position 'B' 200NM distant, would be:
for 'A' 10NM, and for 'B', $10 + 20 = 30\text{NM}$.
8. Should a pressurised aircraft suffer a major loss of cabin pressure when flying above the oxygen height the pilot will put the aircraft into a steep diving turn to bring the aircraft down to 10,000 ft as quickly as possible. The possibility of this manoeuvre being made and the consequent diversion from track should be considered when constructing a probability area.

Probable Navigation error of the Search Craft (y)

9. All search craft are expected to obtain frequent, and near continuous navigational fixes while conducting their search; therefore, only fix error is considered for search craft. Should it be necessary to navigate a search craft by DR in a search area, the RCC should be notified so that both fix and DR error can be taken into account in determining the 'y' factor.

The figures selected in respect of a search craft will depend on the method of navigation to be used by the search craft. The figures in Tables D-6:1 to D-6:3 shall be taken as minimum values and may be increased at the discretion of the SMC.

Appendix D-7 Maritime and Aviation Worksheets

Overview

The following pages provide worksheets to assist in calculating various SAR related problems:

- Worksheet 1: Maritime Planning
- Worksheet 2: Maritime Area (searching by aircraft)
- Worksheet 3: Land Search Calculations
- Worksheet 4: Search Radius
- Worksheet 5: Sector Search
- Worksheet 6: Aircraft Allocation
- Worksheet 7: Maritime Allocation
- Worksheet 8: Maritime Area (searching by vessel)

Worksheet 1: Maritime Planning

Worksheet 1: Maritime Planning				
INCIDENT				
Search target (description):				
LKP (lat / long):				
@Time (UTC):				
Hours of drift (a):				
SEA CURRENT				
Sea / tidal current / knots:	°(T)	knots		
Sea Current vector / distance:	°(T)	knots	x	(a) hrs = nm
SURFACE WIND and WIND CURRENT				
Surface winds / knots	°(T)	knots	Wind Current Divergence = Reciprocal Surface Wind - 30° for LKP greater than 10° South Latitude	
Reciprocal of Surface Winds / Knots (b)	°(T)	knots	-30°T =	°(T) knots
Wind current vector: (use reciprocal bearing and divergence (Figure D-5:25):	(a)	hours x	knots	°(T) nm
TARGET LEEWAY				
Leeway Angles (divergence) (Table D-5:1 or D-5:2):	Reciprocal Surface Wind (b)	°(T)	±	°(T)
Leeway vector: (LW)	L W (L) -	°(T)		L W (R) + °(T)
Leeway speed: (knots) = (Multiplier x Wind Speed) ± Modifier (Table D-5:1 or D-5:2)	[Multiplier x	Wind Speed =] ± Modifier =
Leeway distance:	Leeway speed	x (a)	hrs =	nm
DRIFT ERROR				
Distance (L):	nm	Distance (R):	nm	
de(L):(12.5 to 33% of Distance L)	nm	de (R): (12.5 to 33% of Distance R)	nm	
Distance Left / Right =	nm	$De = \frac{[de (L) + de (R) + Distance L/R]}{2}$	De =	
FIX ERRORS				
Target errors (x): (Table D-6:1, D-6:2 & D-6:3)	nm			
Search craft error (y): (Table D-6:1, D-6:2 & D-6:3)	nm			
TOTAL ERROR (E)				
Total probable error (E): $E = \sqrt{De^2 + x^2 + y^2}$	E =			
SEARCH AREA				
Safety Factor (circle) (fs)	1.1	1.6	2.0	2.3 2.5
Search radius (E x fs)	nm			
Rounded up to whole figure:	nm			
Search area:	nm ²			

Appendices

Worksheet 2 – Maritime Search by Aircraft

Worksheet 2: Maritime Search by Aircraft								
INCIDENT REFERENCE:	COMPLIED BY:							
	DATE:							
Search Platform..... Search Platform TAS..... Search Object.....								
MET Visibility.....KM Wind...../..... Fatigue Factor: YES or NO								
Search Height (AGL)	500 ft	1000 ft	1500 ft	2000 ft				
Uncorrected Sweep Width (WU) -Tables D-5:3, D-5:5, D-5:6(1), D-5:6(2), D-5:7(1), D-5:7(2)	NM	NM	NM	NM				
Maritime: Weather Correction Factor (Fw) -Table D-5:4								
Speed Correction Factor (Fs) a) Aircraft searching over water use Fs from Table D-5:8 b) Searches by vessels enter 1.0								
Fatigue Correction Factor (Ff) if crew will be suffering significant fatigue enter 0.9 otherwise enter 1.0								
Sweep Width Factor W = (Wu x Fw x Fs x Ff)								
Practical Track Spacing S (NM)								
Coverage Factor C = W/S								
Probability of Detection (POD)								
Search Area A (SQ NM)								
Search Hours (T) Required at 120 KTSS (V) T = A/VS								
Total Search Hours Available at 120 KTC (.....) - (from Worksheet 6)								
A. Whole Area Calculated at a Search Height ofFT (A = TVS C = W/S S = W/C)								
A	SQ. NM	S	NM	C	P	%	FOR	SEARCH
B. Modified Area at Calculated Track Spacing in Available Hours								
A	SQ. NM	S	NM	C	P	%	FOR	SEARCH
C. Whole Area at Modified Track Spacing in Available Hours								
A	SQ. NM	S	NM	C	P	%	FOR	SEARCH
D. Compromise Area and Modified Practical Track Spacing in Available Hours								
(i) A	SQ. NM	S	NM	C	P	%	FOR	SEARCH
(ii) A	SQ. NM	S	NM	C	P	%	FOR	SEARCH
(iii) A	SQ. NM	S	NM	C	P	%	FOR	SEARCH
(iv) A	SQ. NM	S	NM	C	P	%	FOR	SEARCH
Mark selected variables with *								

Worksheet 3 – Land Search by Aircraft

Worksheet 3: Land Search by Aircraft								
INCIDENT REFERENCE:	COMPLIED BY:							
	DATE:							
Search Object.....	Vegetation: Less than 15%	15-60%	60-85%	+85%				
MET Visibility.....KM	Fatigue Factor: YES or NO							
Search Height (AGL)	500 ft	1000 ft	1500 ft	2000 ft				
Uncorrected Sweep Width (WU) - Table D-5:9	NM	NM	NM	NM				
Searches over land: use Terrain/Vegetation Correction Factor (Fv) - Table D-5:10								
Fatigue Correction Factor (Ff) if crew will be suffering significant fatigue enter 0.9 otherwise enter 1.0								
Sweep Width Factor W = (Wu x Fv x Ff)								
Practical Track Spacing S (NM)								
Coverage Factor C = W/S								
Probability of Detection (POD)								
Search Area A (SQ NM)								
Search Hours (T) Required at 120 KTSS (V) T = A/VS								
Total Search Hours Available at 120 KTC (.....) - (from Worksheet 6)								
E. Whole Area Calculated at a Search Height ofFT (A = TVS C = W/S S = W/C)								
A	SQ. NM	S	NM	C	P	%	FOR	SEARCH
F. Modified Area at Calculated Track Spacing in Available Hours								
A	SQ. NM	S	NM	C	P	%	FOR	SEARCH
G. Whole Area at Modified Track Spacing in Available Hours								
A	SQ. NM	S	NM	C	P	%	FOR	SEARCH
H. Compromise Area and Modified Practical Track Spacing in Available Hours								
(i) A	SQ. NM	S	NM	C	P	%	FOR	SEARCH
(ii) A	SQ. NM	S	NM	C	P	%	FOR	SEARCH
(iii) A	SQ. NM	S	NM	C	P	%	FOR	SEARCH
(iv) A	SQ. NM	S	NM	C	P	%	FOR	SEARCH
Mark selected variables with *								

Appendices

Worksheet 4 – Search Radius

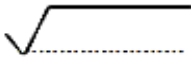
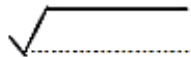
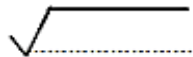
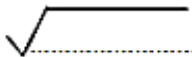
Incident Reference	Search and Rescue				Compiled By	
	Worksheet No. 4 Search Radius				Date	
Reported Distress Position S E Time UTC	or	1. Last Positive Fix			Search No.	Distress Craft Callsign/Identity
		2. Last Reported Posn			Radius Computed	
		3. Missed position			For Search Commencing UTC	
		4. Next Posn or Dest			Previous Search No.	
					Radius Computed	
					For Search Commenced UTC	
	Position	A	B	C	D	
Track distance since last Positive Fix	(Tr)	
Distress Craft Position Error (Fix+10%Tr)	(x)	
Search Craft Navigation Error	(y)	
Probable Error of Position	(e)					
$e = \sqrt{x^2 + y^2}$		
Safety Factor for this search (1.1; 1.6; 2.0; 2.3; 2.5)	(fs)	
Search Radius (R) = (e) x (fs)	(R)	
Rounded up Radius		

Worksheet 5 – Sector Search

INCIDENT REFERENCE			SEARCH AND RESCUE WORKSHEET NO.5 SECTOR SEARCH				COMPILED BY _____ DATE: _____		
SECTOR SEARCH CALCULATIONS: SPLASH POINT or DATUM _____ S / _____ E									
RADIUS _____ NM			C = W/MTS			TRACK MILES AVAILABLE FROM WORKSHEET No 6 _____ NM			
SEARCH HEIGHT (FT)	W	MTS	C	TRACK DISTANCE (D)	ANGULAR DISPLACEMENT (AD)	INITIAL TRACK (IT)	SUBSEQUENT TRACK ADJUSTMENT +/- (90 + AD/2)	POD	
500									
1000									
1500									
2000									
RADIUS _____ NM			C = W/MTS			TRACK MILES AVAILABLE FROM WORKSHEET No 6 _____ NM			
SEARCH HEIGHT (FT)	W	MTS	C	TRACK DISTANCE (D)	ANGULAR DISPLACEMENT (AD)	INITIAL TRACK (IT)	SUBSEQUENT TRACK ADJUSTMENT +/- (90 + AD/2)	POD	
500									
1000									
1500									
2000									
RADIUS _____ NM			C = W/MTS			TRACK MILES AVAILABLE FROM WORKSHEET No 6 _____ NM			
SEARCH HEIGHT (FT)	W	MTS	C	TRACK DISTANCE (D)	ANGULAR DISPLACEMENT (AD)	INITIAL TRACK (IT)	SUBSEQUENT TRACK ADJUSTMENT +/- (90 + AD/2)	POD	
500									
1000									
1500									
2000									

Appendices

Worksheet 6 – Aircraft Allocation

INCIDENT REFERENCE		SEARCH AND RESCUE WORKSHEET NO.6 AIRCRAFT ALLOCATION					AREA to be ALLOCATED _____ NM ²			COMPILED BY _____ DATE _____		
Sunrise		UTC	Sunset		UTC	FSL	UTC – LSL		UTC = TSL	Hours	Mins	
Remarks	ACFT Type	Time AVBL	DIST	TRANS TI's	ETA Area	Actual SCH HRS (ASH)	ETD Area	ASH less 15%	SCH TAS	AREA ALLOCATED		
	Callsign	TKOF Time	TRANS TAS	ON SCH ENDCE				S	HRS (T) at 120 kt (V)	A=TVS	Dim's Used	ALLOC Area (NM ²)
										Cal Dim's	No. of Legs	
E/												
E/												
E/												
E/												
E/												
E/												
E/												

Worksheet 8 – Maritime Search by Vessel

INCIDENT REFERENCE	SEARCH AND RESCUE WORKSHEET NO. 8 MARITIME SEARCH BY VESSEL	COMPILED BY _____						
		DATE _____						
Search Platform		Search Object						
MET Visibility KM	Wind /..... kt	Fatigue Factor: Yes or No						
Search Height (AGL)	Eye height 8 ft	Eye height 14 ft	MERSHIP					
Uncorrected Sweep Width (Wu) -Tables D-5:3 & D-5:5	NM	NM	NM					
Maritime: Weather Correction Factor (Fw) – Table D-5:4								
Fatigue Correction Factor (Ff) if crew will be suffering significant fatigue enter 0.9 , otherwise enter 1.0								
Sweep Width Factor W = (Wu x Fw x Ff)								
Practical Track Spacing S (NM)								
Coverage Factor C = W/S								
Probability of Detection (POD)								
Search Area A (SQ NM)								
Search Hours (T) Required T = A/VS								
Total Search Hours Available (.....) - (from Worksheet No.7)								
A. Whole Area Calculated at a Search Height of FT (A = TVS C = W/S S = W/C)								
A	SQ. NM	S	NM	C	P	%	FOR	SEARCH
B. Modified Area at Calculated Track Spacing in Available Hours								
A	SQ. NM	S	NM	C	P	%	FOR	SEARCH
C. Whole Area at Modified Track Spacing in Available Hours								
A	SQ. NM	S	NM	C	P	%	FOR	SEARCH
D. Compromise Area and Modified Practical Track Spacing in Available Hours								
(i) A	SQ. NM	S	NM	C	P	%	FOR	SEARCH
(ii) A	SQ. NM	S	NM	C	P	%	FOR	SEARCH
(iii) A	SQ. NM	S	NM	C	P	%	FOR	SEARCH
(iv) A	SQ. NM	S	NM	C	P	%	FOR	SEARCH
Mark selected variables with *								

Appendix D-8 Aircraft Accident Site Precautions

Safety Precautions and Procedures at Aircraft Accidents

1. Always remember that ADF aircraft may be carrying ammunition, bombs, rockets, etc. Ejector seats are powered by explosives. Contact ADF authorities as soon as possible.
2. The following precautions should be observed at all aircraft accident sites:
 - a) Attendance at crash sites should be limited to essential personnel;
 - b) Personnel should wear Personnel Protective Equipment (PPE) - see paragraph 2;
 - c) All work at the crash site should be conducted upwind of the wreckage wherever possible;
 - d) The location of helicopter landing zones in close proximity to crash sites should be avoided to prevent the possible spread of contamination;
 - e) Eating, drinking, and smoking in or around the crash site should be prohibited;
 - f) Aircraft technical personnel familiar with the aircraft type should be utilised in the location, identification, and salvage of hazardous materials and remnants;
 - g) Environmental health personnel should also be notified when suspected dangerous substances are present at the accident site;
 - h) SAR personnel who were working at the accident site should shower as soon as possible after leaving the area;
 - i) If time permits, advice to civilians in fallout areas that are not otherwise threatened should be as follows:
 - i) Remain indoors;
 - ii) Shut external doors and windows;
 - iii) Turn off forced air intakes; and
 - iv) Await further notification. and
 - v) Cordon off the area.
3. Personnel working within 10 metres of any ADF crash site should wear the following protective equipment:
 - a) Respiratory protection; wear National Institute of Occupational Safety and Health approved full-face or half-mask respirators with cartridges for organic vapours (for protection from jet fuel) and for dust, mist, and fumes (for airborne particulate fibres and other dust). All personnel must be fit, tested, and trained in the use of respirators. The use of full-face respirators will eliminate the need for goggles or safety glasses;
 - b) Eye protection such as goggles or safety glasses with side shields shall be worn when a half-face respirator is used; and
 - c) Skin protection:
 - i) Coverall - Tyvek, coated with 1.25mm polyethylene with hood. The coveralls should have a zipper front, elastic sleeves, legs, and drawstring hood;
 - ii) Gloves - Puncture resistant leather gloves shall be worn. The environmental engineers will determine any additional requirements;
 - iii) Boots - Steel toed shoes or boots should be worn; and
 - iv) All equipment should be thoroughly washed before removal.

Appendices

Appendix D-9 Civil Aircraft Search and Rescue Assets (SRAs)

AMSA Aircraft Tier SRA Capability Definitions

CAPABILITY	DESCRIPTION
TIER 1	Dedicated fixed wing aircraft and crews, capable of electronic and visual search, deployment of emergency supplies, command and control, and homing to distress beacons.
Rotary Wing Rescue (RWR)	Rescue capable and winch-equipped helicopters and crew for rescue, homing to distress beacons, visual search, and limited supply dropping.
Rotary Wing Search (RWS)	Helicopters and crew for homing to distress beacons and visual search.
Fixed Wing Search (FWS)	Fixed wing aircraft and crew for homing to distress beacons, visual search and communications relay.

Table D-9:1 AMSA Aircraft SRA Tier Definitions

Tier 1 SRAs

AMSA contracts four dedicated Bombardier Challenger 604 jet aircraft for SAR at bases in Perth, Cairns and Melbourne with the fourth aircraft an operational spare. These aircraft have been modified to have a large visual observation window on each side and are fitted with a range of communications (UHF, VHF, HF and satellite telephones) and sensor systems (search RADAR, high definition EO/IR turret, NVDs, DF, AIS, ADS-B, video anomaly detection). These Challenger 604s are able to drop a range of life-support equipment on land and sea, by day and night including life rafts, SAR datum marker buoys and de-watering pumps. Communications equipment (radios and satellite phones) can also be dropped which, using the multi-mode communications relay capability of the aircraft, enable communications to be established between the surface and JRCC Australia or another command/control or response facility.

The aircraft are available to other government agencies, such as the police, fire and emergency services, on a whole of government basis, for assistance with response to emergency operations.



Photo: AMSA Challenger 604

Opportunity Based SAR Services

In addition to the dedicated Challenger 604 services contracted to Cobham SAR Services Pty Ltd, AMSA has existing arrangements with a number of Federal, State and Territory governments and agencies and other fixed wing and helicopter operators to provide AMSA with SAR services on an opportunity basis, that is, they are not dedicated AMSA services. These fall into the three categories in Table D – 9.1 above.

The aircraft available to AMSA include a range of aircraft operated or used by Federal, State and Territory governments, such as Australian Border Force, State/Territory Ambulance and Police Services and Australian Defence Force aircraft. AMSA also has arrangements with commercial operators for the use of a large selection of aircraft located around Australia.

The tasks capable of being conducted by these aircraft will vary based on individual capability, but aircraft will be capable of providing one or possibly more of the following:

- Visual searches - (both fixed wing and rotary wing) conducted either over land or water. Visual searches will be conducted either over land or water. Visual searches will be conducted during daylight hours and will not usually be conducted at altitudes below 500ft for fixed wing, but often lower for rotary wing. Observers, trained in aerial visual searching techniques, may be nominated by AMSA for carriage on the aircraft during search operations.
- Rescue - generally effected by rescue winch either over land or water. Winching operations will typically be conducted only during day visual meteorological conditions (VMC) unless operators are equipped, trained and authorised to conduct winching operations at night.
- Electronic searches - will be conducted by aircraft with electronic sensors, including search RADAR, NVDs or EO/IR. These aircraft may be used over land or water. Electronic searching can be conducted by day and/or night in VMC and/or instrument meteorological conditions (IMC).
- Deployment of emergency supplies - by rescue helicopters. This will be conducted only during day VMC, unless the operator is approved to deploy supplies at night.

Appendices

- Homing to distress beacons - (both fixed wing and rotary wing) is conducted by aircraft equipped with an electronic homer (direction finder), or using aural homing techniques, either over land or water. Homing to beacons can be conducted either by day or night in both VMC and IMC.
- Communications relay - is conducted by fixed wing aircraft when communications with other search assets are poor or where there is a need to relieve congestion on ATS frequencies. Aircraft are required to be able to maintain communication with SAR or other assets or a ground station.

Current Aircraft and Police Fixed-Wing Operators

Fixed Wing Search (FWS) aircraft operators provide air search capability (visual search and DF) supportive and supplementary to the Tier 1 Challenger fleet. Each operator is supplied with safety and role equipment. Training, including emergency procedures drills, is provided by AMSA. AMSA Fixed Wing Search operators are located at various locations as shown in Figure D-9:3. AMSA also provides police fixed-wing operators with safety and role equipment for selected aircraft.

Air Search Observer Programme

AMSA maintains a partnership with State/Territory Emergency Service organisations to provide the SAR system with a large and dispersed pool of trained and readily mobilised air search observers. State and Territory Emergency Service volunteers undertake several days of initial training and regular refresher training, addressing safety on and around aircraft, emergency procedures (including pool drills with life rafts and lifejackets) and air search operations.

Air Search Equipment

AMSA maintains stocks of air search equipment (aircraft safety and role equipment) at strategic sites which can be transported to locations where search operations are being conducted.

Locations of Tier 1, 2 Assets

The following charts show the distribution of assets as at August 2018.

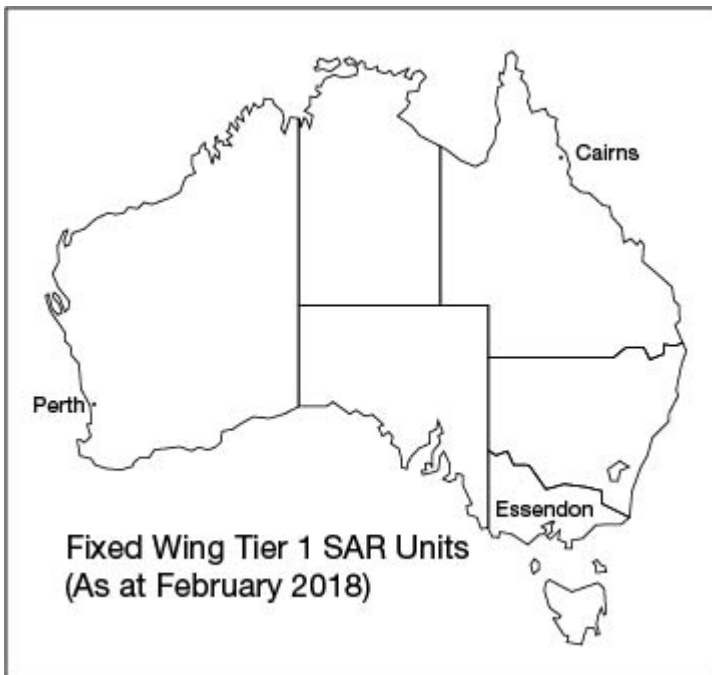

Figure D-9:1 Base Locations of AMSA Dedicated Tier 1 Aircraft SRAs

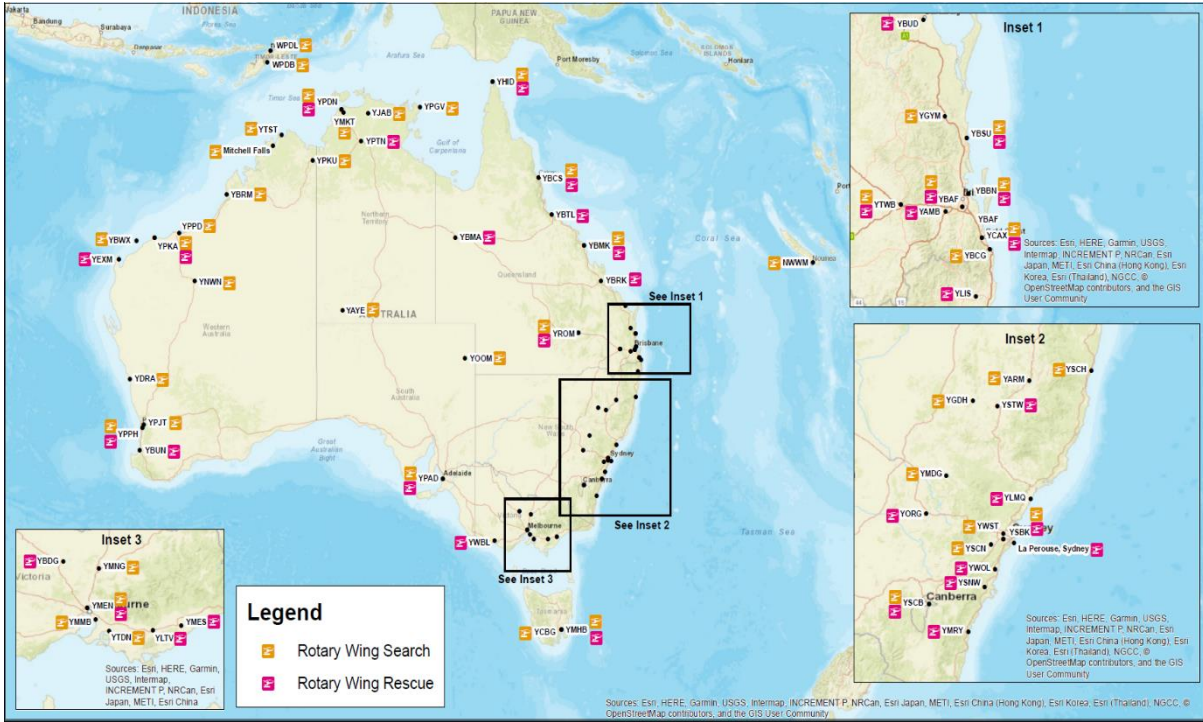

Figure D-9:2 Base Locations of Rotary Wing Search and Rotary Wing Rescue SRAs

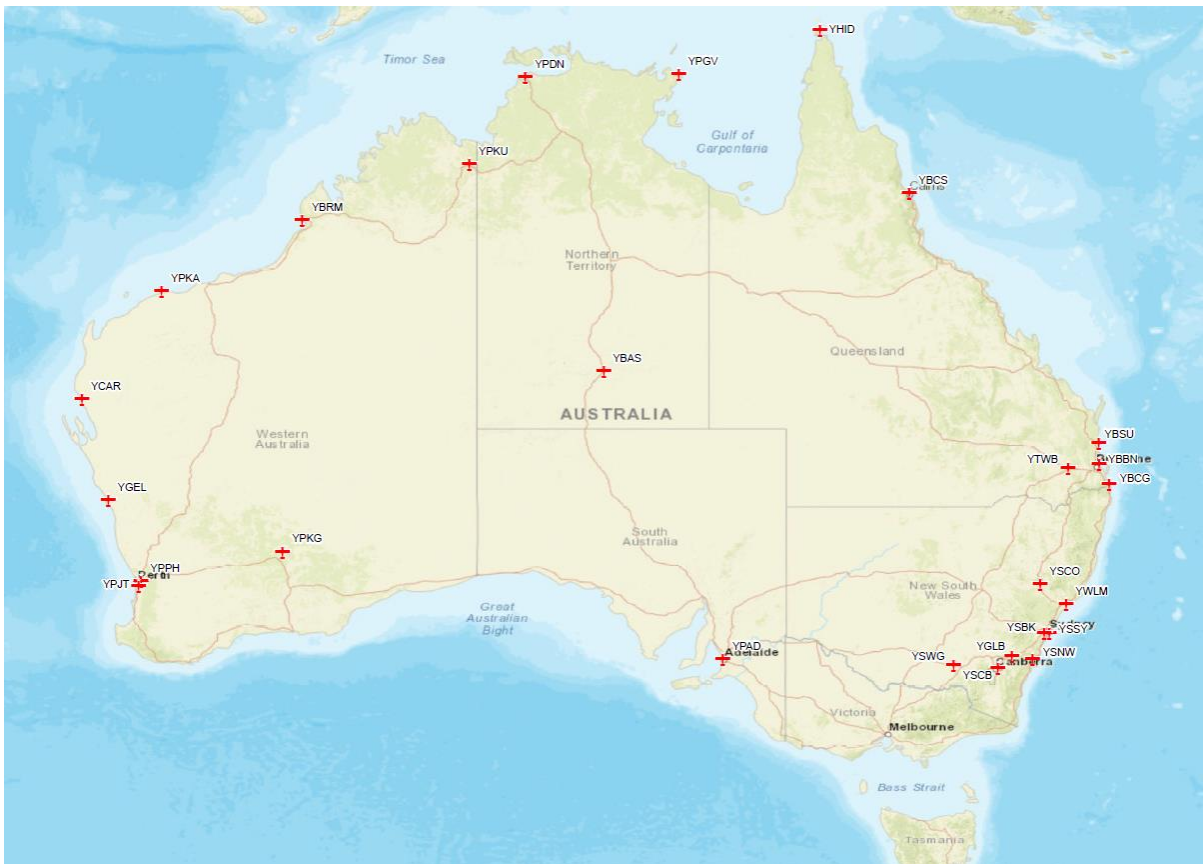

Figure D-9:3 Base Locations of Fixed-Wing Search and Police Fixed-Wing Aircraft SRAs

Appendices

Appendix D-10 Coastal Datum Search and Rescue Planning

A Step-By-Step Guide for SAR Trained Personnel

Vessel Adrift

This is the simplest of all the datum SAR planning models. It is used when the last position of the vessel is known to within a high degree of accuracy.

Datum should be calculated for a time when the search assets are likely to be on scene. There is no point in calculating datum for a specific time, if there will be no resources in place to commence a search at this time.

Remember:

All chart work is plotted in true on the chart.

Wind is always referred to as blowing from (a Southerly wind is blowing South to North).

Current is referred to as setting towards (a Westerly current is travelling East to West).

To commence the planning process, the planner will need some critical information, which is outlined below:

- a) **Target** type(s) must be determined.
- b) **Current**, the sea current direction and velocity must be determined as accurately as possible. With more accurate intelligence, as the operation progress, this part of the plan can be adjusted. All plots are directly down current and the current rate multiplied by the number of hours adrift is applied.
- c) **Wind**, the wind direction and velocity must be determined as accurately as possible for the time that the incident occurred as well as what is happening for when datum is calculated. The target type is then used to calculate the leeway effect by referring to the Leeway Tables. All plots are directly downwind with the leeway rate determined (as described) multiplied by the number of hours adrift is applied.
- d) **Splash Point (SP)**, sometimes referred to as the Last Known Position (LKP) or Initial Position (IP). This is the last known position of the target when it became the target of the operation. In accordance with the definition of datum a time (clock time) and position (Latitude and Longitude) must be given.

For the purpose of this user guide the following example, with critical information, is used:

- a) **Target**
Light Displacement Cabin Cruiser (Without Drogue).
- b) **Current**
2 knots South Easterly (towards the S.E.)
- c) **Wind**
10 knots North Easterly (from the N. E.)
- d) **Splash Point**
27° 45.2' S 151° 27.1' E at 0800hrs.
- e) **Calculate a Datum for 1000hrs**
- f) **Current (WC)**
135° at 2kns per hour. 2kns x 2hrs = 4nm for the water current leg
- g) **Wind**
045° at 10kns. Using the Leeway Formula:
 $[(0.07 \times 10) + 0.04] \times 2\text{hrs} = 1.48\text{nm}$

Step-By-Step Guide

1. Plot the Splash Point (SP) on the chart, and notate as shown below in diagram 1. Splash point can also be known as Last Known Position (LKP) or Initial Planning Point (IPP).



Diagram 1

2. Plot the Total Water Current (WC) leg first, as shown in diagram 2 below. The reason for this is that if there is a possibility that the target is a person in the water, then the end of the WC leg becomes datum (D1). As shown in diagram 3.

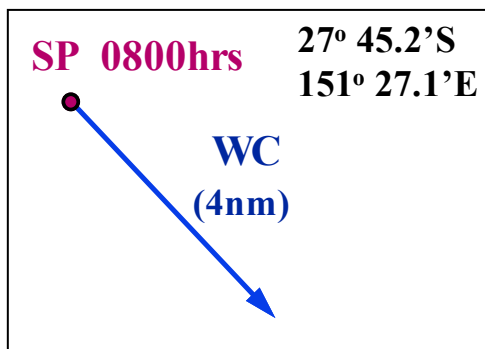

Diagram 2

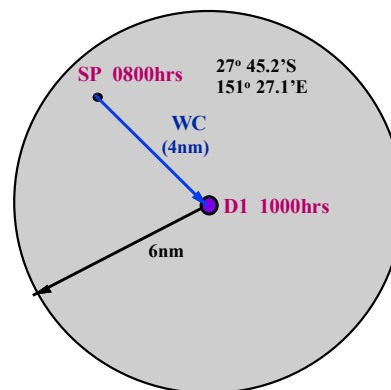

Diagram 3

Note: If there is doubt as to whether the target is a person in the water or a vessel, then D₁ is plotted at the end of the WC leg, D₂ would then be plotted at the intersection of the Leeway (LW) leg and Total Drift (TD) leg. See diagram 9. Vessel Adrift

3. Plot the Leeway leg (LW) second. This leg commences at the end of the WC leg. The length of the LW leg is calculated by using the Leeway tables. See Diagram 4 below.

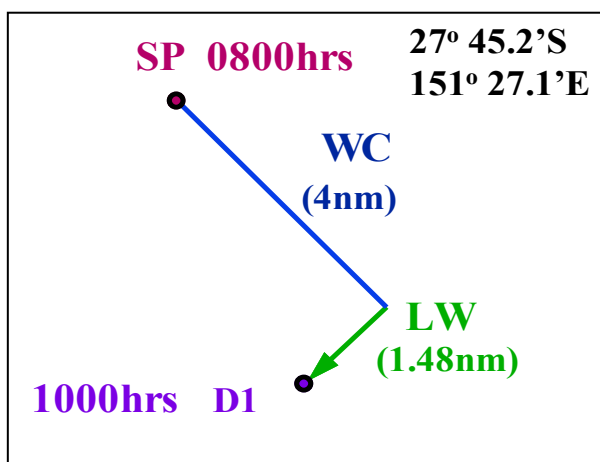

Diagram 4

Appendices

The target type must be interpolated with the classes of vessels given. If it appears that the target could fall into more than one type, then calculate for both and plot both. The datum points arrived at will not differ by a great deal. Use both datum points to calculate the search area.

In this case using the formula for the target, which is a light displacement cabin cruiser without drogue
 $0.07U + 0.04$.

$0.07U + 0.04$.

$0.07 \times$ the wind speed + $0.04 \times$ hours and decimals of an hour the vessel had been adrift.

- Once both the WC and LW legs have been plotted, draw a line from SP to D1. The name of the line is called the 'Total Drift' or 'Resultant', indicate the direction of travel with an arrowhead in the centre of the line. Also note the direction of the TD line with a True bearing and measure the distance. See Diagram 5 below.

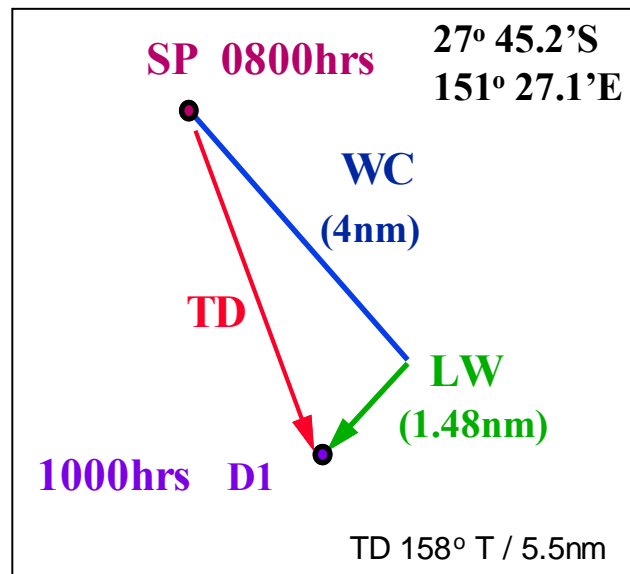

Diagram 5

- A 6nm radius circle is drawn centred on datum (a 6nm radius is used if the TD line is less than 8nm in length), as indicated in Diagram 6 below.

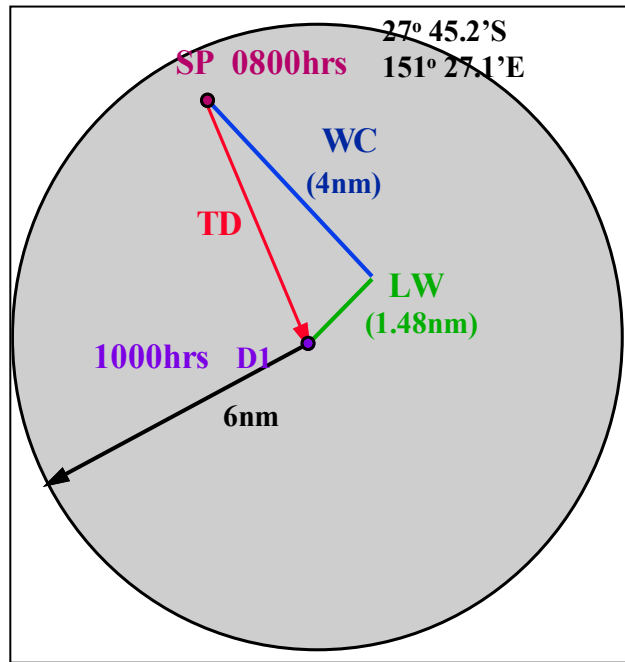

Diagram 6

6. Once the circle is drawn, the area should be boxed, with the sides of the box touching the edges of the circle (tangential), and oriented in the direction of drift. This errs on the side of safety by building in a greater safety margin. It is also easier to plan search patterns and brief resources. See Diagram 7 below.

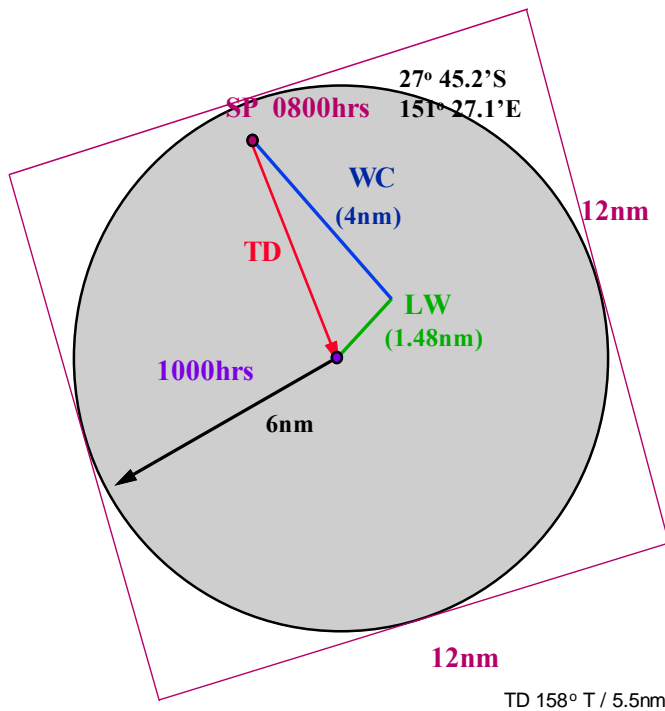
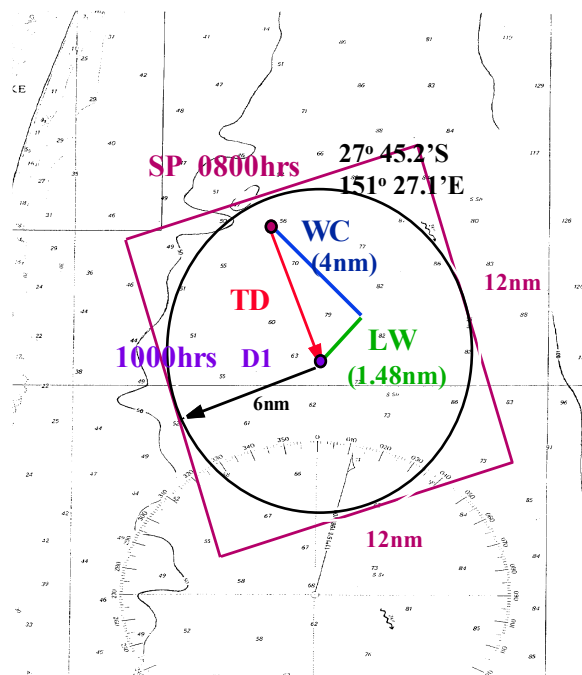

Diagram 7

Appendices

7. Diagram 8 below, shows what the datum SAR plan will look like on a chart.



TD 158° T / 5.5nm

Diagram 8

8. If there was uncertainty as to whether the target was a person in the water or a vessel adrift then Datum 1 (D1) should be located at the end of the water leg and Datum 2 (D2) should be located at the end of the leeway leg. Diagram 9 below shows the two circles one centred at (D1) and the other centred on (D2). The two circles would then be boxed (rectangle) together, with the box oriented in the direction of drift.

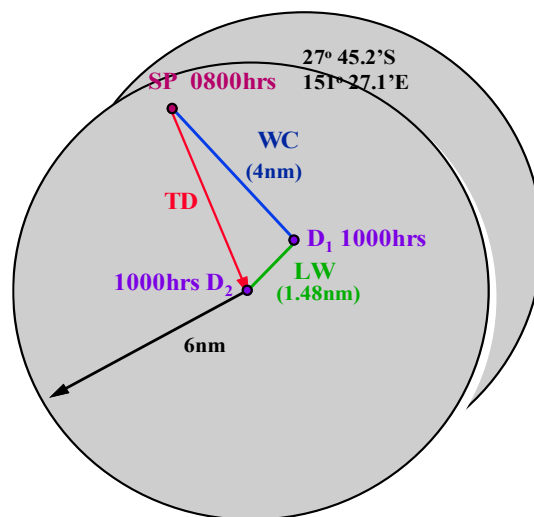

TD 158° T / 5.5nm

Diagram 9

9. As stated, if the total drift (TD) line is less than 8 nautical miles, then the radius of the circle is 6nm, see Diagram 10 below.

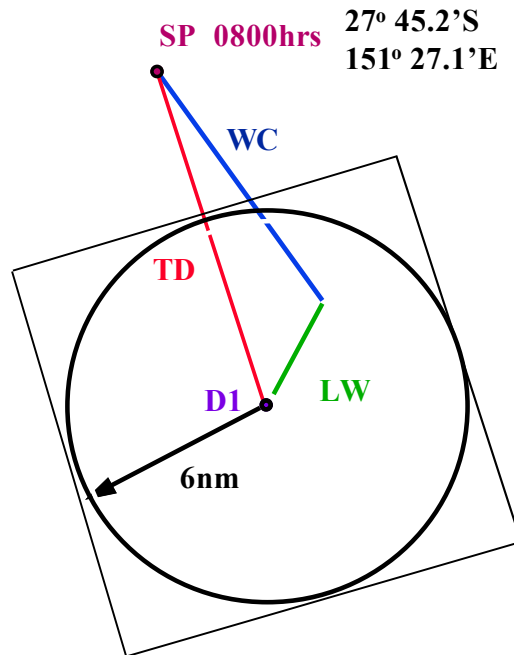

Diagram 10

10. If the total drift (TD) line is greater than 8 nautical miles, then the length of the total drift line is divided by 8. This is known as individual drift error.

The result is ADDED to the 6nm radius circle usually used, creating a larger circle.

In Diagram 11 below, the TD line is 12nm long. Therefore $12 \div 8 = 1.5\text{nm}$. 1.5nm is then added to 6nm (the standard circle diameter) and the result is 7.5nm for the radius of the circle.

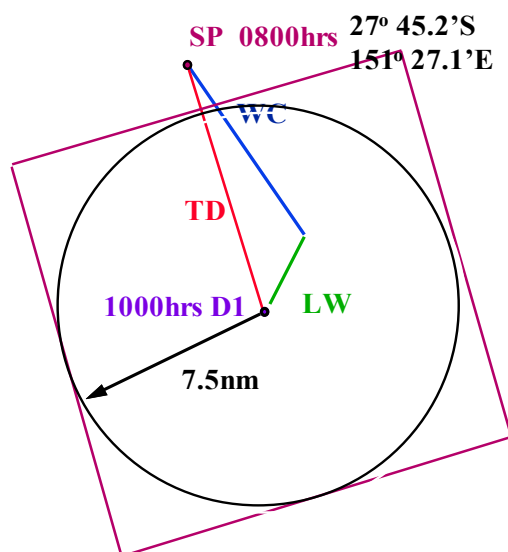

Diagram 11

Appendices

Position Uncertainty

This model is a little bit more complex. It is the search procedure used when the intelligence has placed the Splash Point at more than one location, at the same point in time. It is important that Splash Points are calculated for the same specified time, it is just the positions that are different.

Datum should be calculated for a time when the search assets are likely to be on scene. There is no point in calculating datum for a specific time, if there will be no resources in place to commence a search at this time.

For the purpose of this user guide the following example, with critical information, is used:

- a) **Target**
Light Displacement Cabin Cruiser (Without Drogue).
- b) **Current**
1.5 knots 010°T
- c) **Wind**
10 knots Westerly (from the West) 270°T
- d) **Splash Point**
Two positions for the same specified time at 1000hrs
- e) **Calculate a Datum for 1330hrs**
- f) **Current (WC)**
030°T at 1.5kns per hour. $1.5\text{kns} \times 3.5\text{hrs} = 5.25\text{nm}$ for the water current leg
- g) **Wind (LW)**
270°T at 10kns. Using the Formula: $[(0.07 \times 10) + 0.04] \times 3.5\text{hrs} = 2.59\text{nm}$

Step-By-Step Guide

1. Plot the splash points (SP) on the chart, and notate as shown below in diagram 1. Splash point can also be known as Last Known Position (LKP) or Initial Position (IP). Two positions geographically separated at the same time. This position can be caused by conflicting intelligence, confusion over a headland, island or bay.

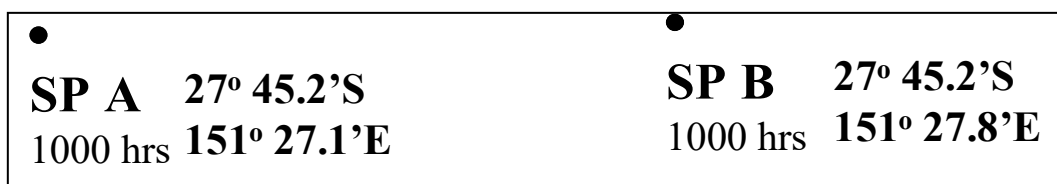

Diagram 12

2. Plot the Water Current (WC) leg first as per convention (see Diagram 13).

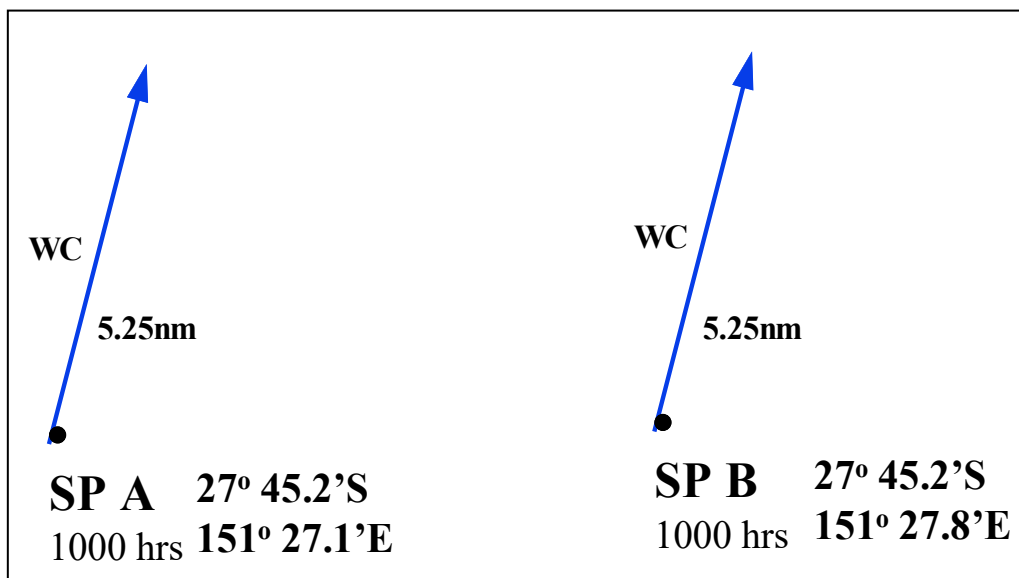

Diagram 13

Note: If there is doubt as to whether the target is a person in the water or a vessel, then two separate plots will be done, one for the person and one for the vessel, with both plotted together resulting in a larger search area.

- Plot the Leeway leg (LW) second. This leg commences at the end of the WC leg. The length of the LW leg is calculated by using the Leeway Tables.

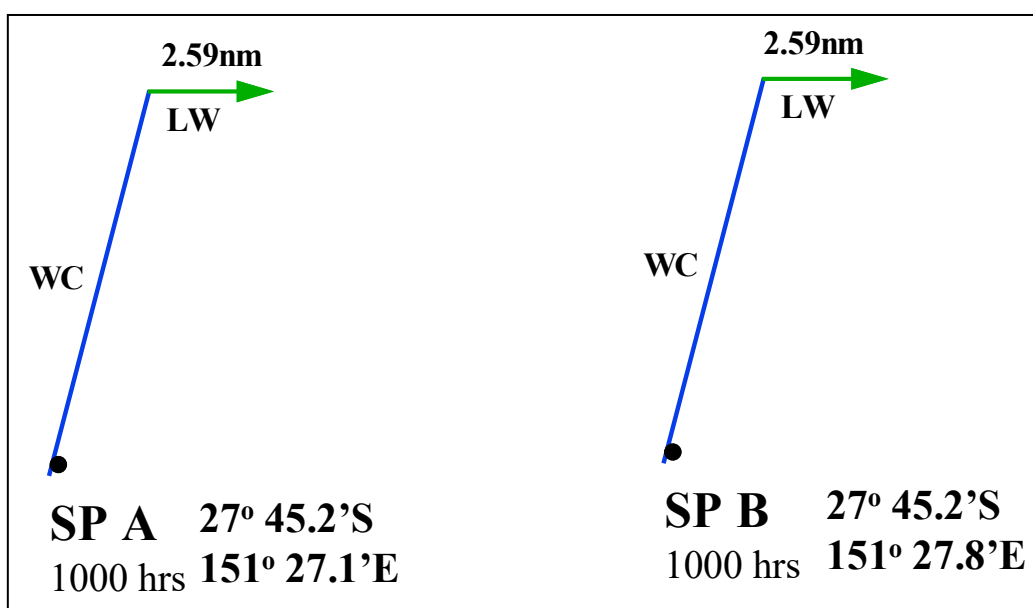

Diagram 14

- Once both the WC and LW legs have been plotted, draw a line from SP to D1. The name of the line is called the 'Total Drift' or 'Resultant', indicate the direction of travel with an arrowhead in the centre of the line. Also note the direction of the TD line with a True bearing and measure the distance (see Diagram 15 below).

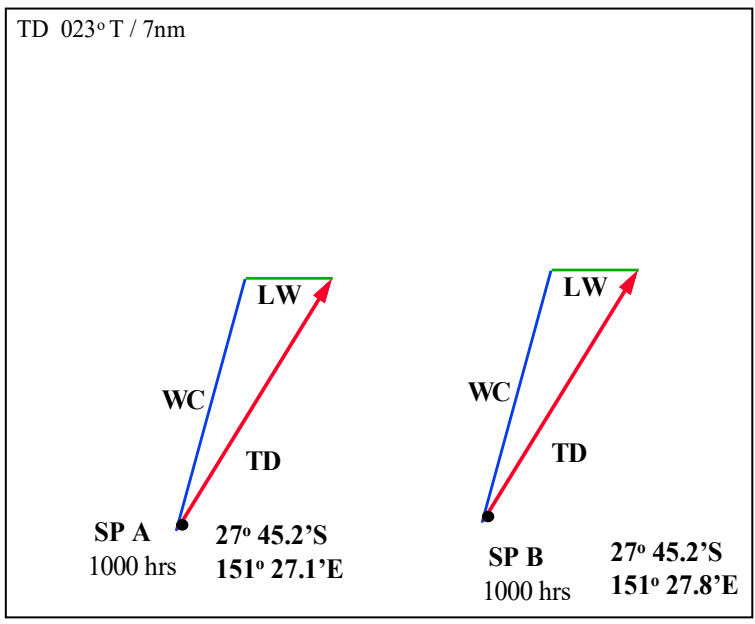

Diagram 15

5. A 6nm radius circle is drawn centred on datum (a 6nm radius circle is used if the TD line is **less than** 8nm in length, if greater than 8nm apply the error mentioned in the Vessel Adrift example). As indicated in Diagram 16 below. A circle is drawn on both datum's.

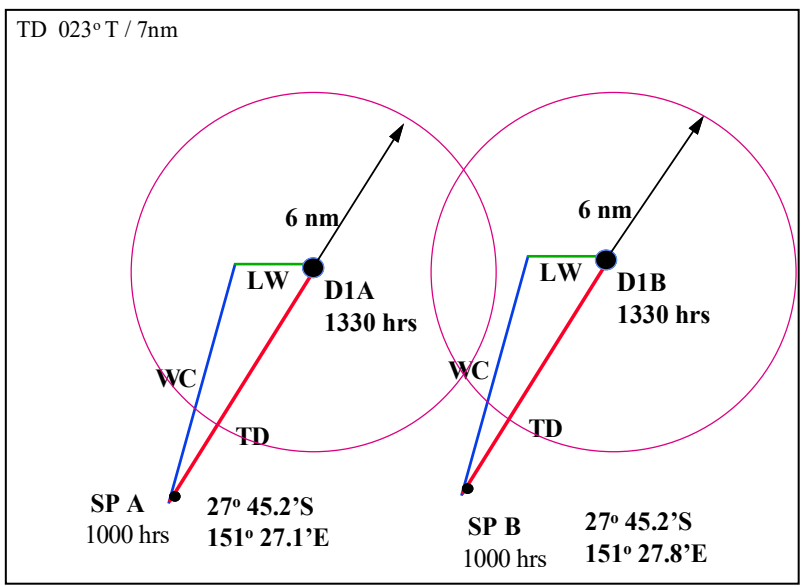

Diagram 16

6. Once the circles are drawn, the area should be boxed, with the sides of the box touching the edges of the circles (tangential), and oriented in the direction of drift. This errs on the side of safety by building in a greater safety margin. It is also easier to plan search patterns and brief resources. See Diagram 17 below.

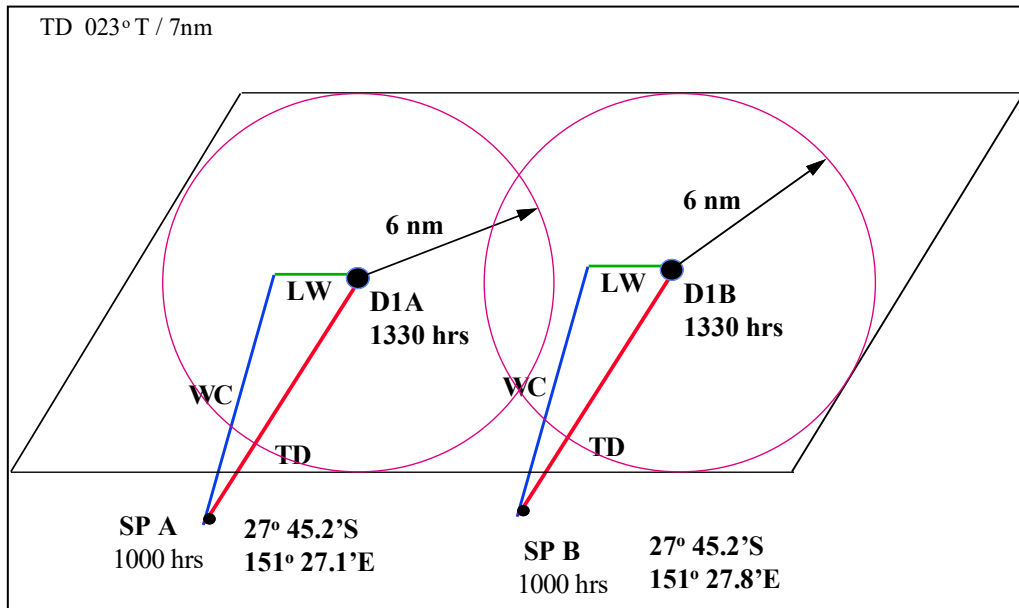

Diagram 17

- If the circles are separated by extreme distance, greater than 12nm apart, then each area should be treated separately. In the prioritisation of search areas, the area between the two circles would be considered high in priority. If practicable, and a suitable number of resources are available, the area between the circles should be incorporated into the initial search area. See Diagram 18 below.

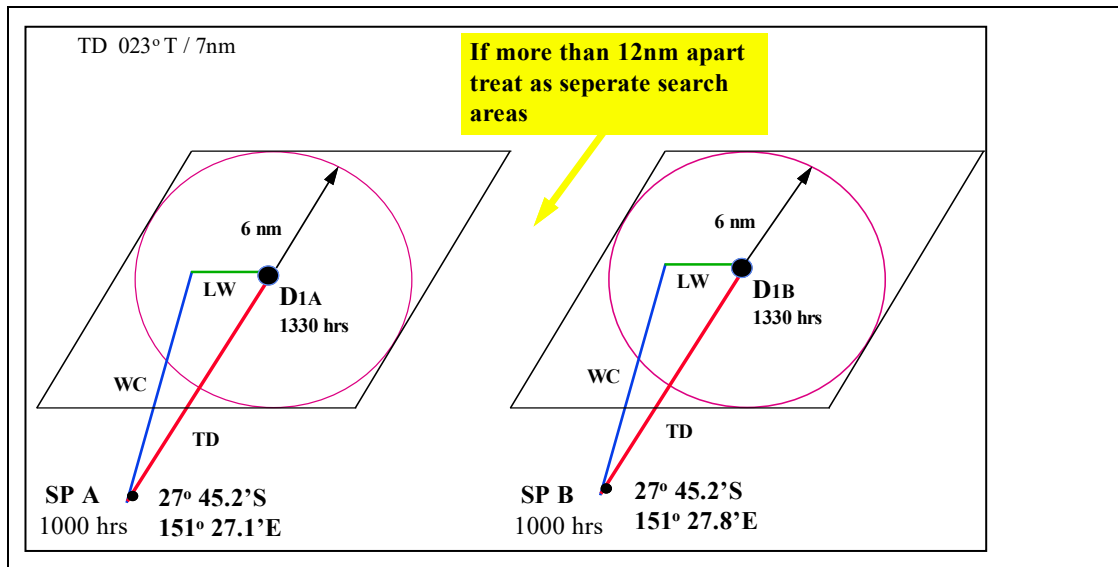

Diagram 18

Time Uncertainty

This model again is a little bit more complex. It is the search procedure used when the intelligence has placed the Splash Point at the one location, but at different points in time. For example, the target was known to be at the splash point, however there is conflicting evidence as to the time.

It is important that Splash Point is calculated for the both the minimum and maximum amount of time that the target could be missing, ascertained through the gathering of intelligence.

Appendices

For the purpose of this user guide the following example, with critical information, is used:

- a) **Target**
Light Displacement Cabin Cruiser (Without Drogue).
- b) **Current**
1.5 knots 100°T
- c) **Wind**
10 knots 018°T
- d) **Splash Point**
27° 45.2' S 151° 27.1' E. The earliest the target may have got into trouble is 1000hrs and the latest time the target may have got into trouble is 1200hrs.
- e) **Calculate a Datum for 1400hrs**
- f) **Current (WC)**
100°T at 1.5kns per hour.
Position A - 1.5kns x 2hrs = 3nm for the TWC (1200hrs to 1400hrs = 2hrs)
Position B - 1.5kns x 4hrs = 6nm for the TWC (1000hrs to 1400hrs = 6hrs)
- g) **Wind (LW)**
018°T at 10kns. Using the Formula: $[(0.07 \times 10) + 0.04] = .74\text{nm per hr}$
Position A - $.74\text{nm} \times 2 \text{ hrs (time adrift)} = 1.48\text{nm}$ for the Leeway leg
Position B - $.74\text{nm} \times 4 \text{ hrs (time adrift)} = 2.96\text{nm}$ for the Leeway leg

Step-By-Step Guide

1. Plot the Splash Point (SP) on the chart, and notate as shown below in Diagram 19. Splash point can also be known as Last Known Position (LKP) or Initial Position (IP).

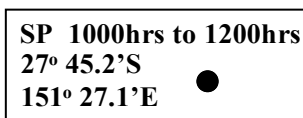

Diagram 19

2. Plot the Water Current (WC) leg first. The reason for this is that if there is a possibility that the target is a person in the water, then the end of the WC leg becomes datum (D1). As shown in Diagram 20 below.

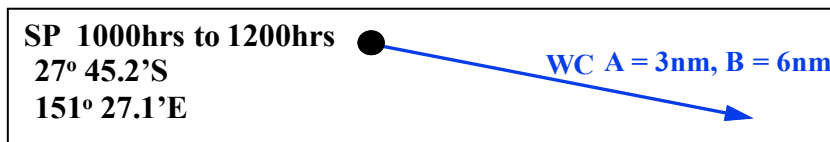

Diagram 20

3. Plot the Leeway leg (LW) second. In this case there are two leeway legs. The first of the leeway legs calculated is the amount of leeway effect on the vessel between 1000hrs and 1400hrs (this is the longest period of time in the calculation) and commences at the end of the WC leg.

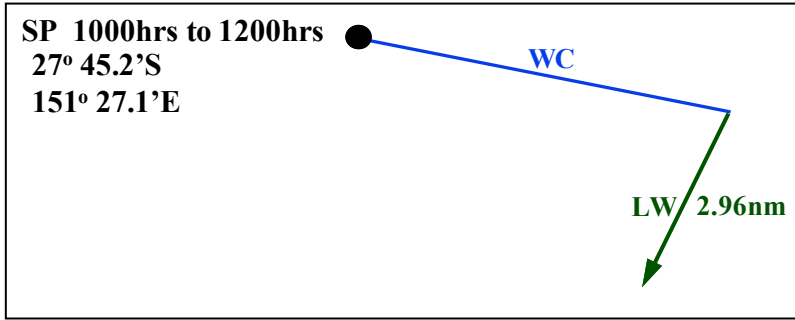

Diagram 21

- Plot the second Leeway leg (LW). In this case the second leeway leg calculated is the amount of leeway effect on the vessel between 1200hrs and 1400hrs (this is the shortest period of time in the calculation). The leg commences at the corresponding point along the WC leg (which in this scenario is at the 2nd hour of water current effect along the WC line).

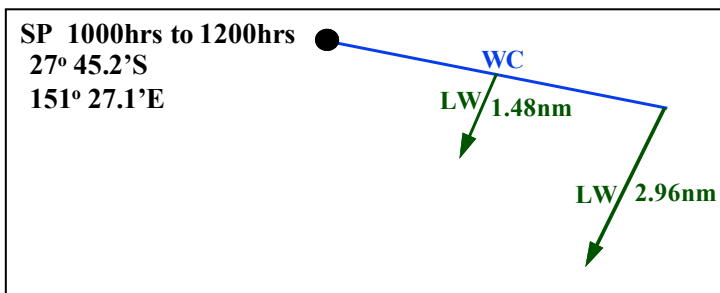

Diagram 22

- Once both the WC and both LW legs have been plotted, draw a line from SP to through D1A to D1B. The name of the line is called the 'Total Drift' or 'Resultant'. Indicate the direction of travel with an arrowhead in the centre of the line. The TD line should touch the end of the shortest LW line. If it does not touch, or the LW is too long or too short, re-check the calculations. See Diagram 23 below.

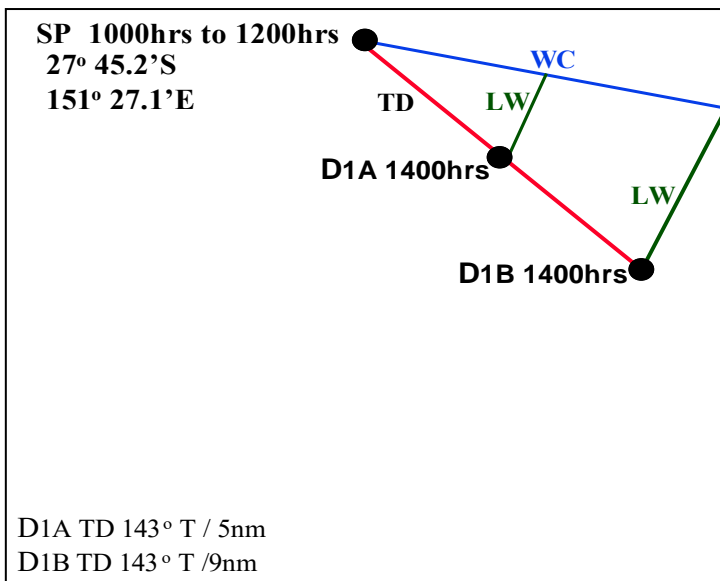

Diagram 23

Appendices

6. D1A is plotted at the end of the first LW leg and D1B is plotted at the end of the longest LW leg. Note the direction of the TD line with a True bearing and distance.
7. The length of the TD line between SP and D1B is 9nm in this particular scenario. Therefore the length of the TD line is divided by 8 and the result is added to the 6nm radius circle, which is normally used. In this case the radius of the circle centred on datum D1B is calculated as $9 \div 8 = 1.125$. $6 + 1.1 = 7.1$ nm. See Diagram 24 below.

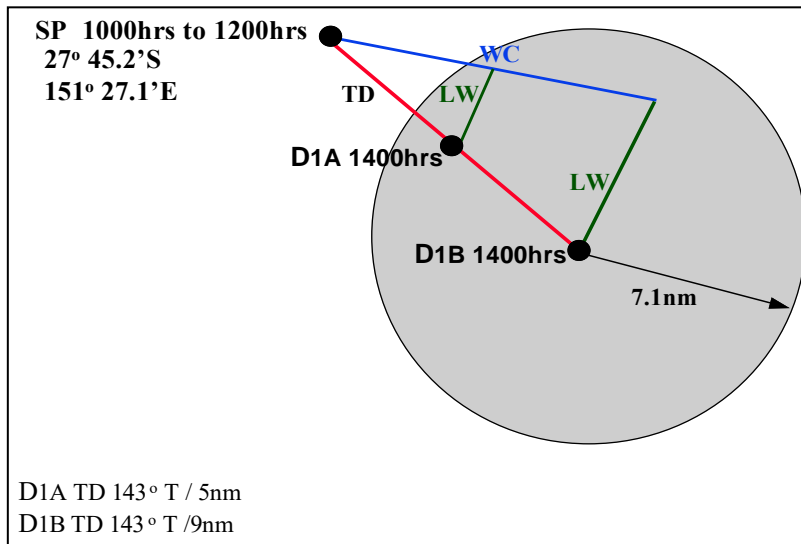

Diagram 24

8. The length of the TD line between SP and D1A is less than 8nm in length. Therefore a 6nm radius circle is drawn centred on datum D1A. See Diagram 25 below.

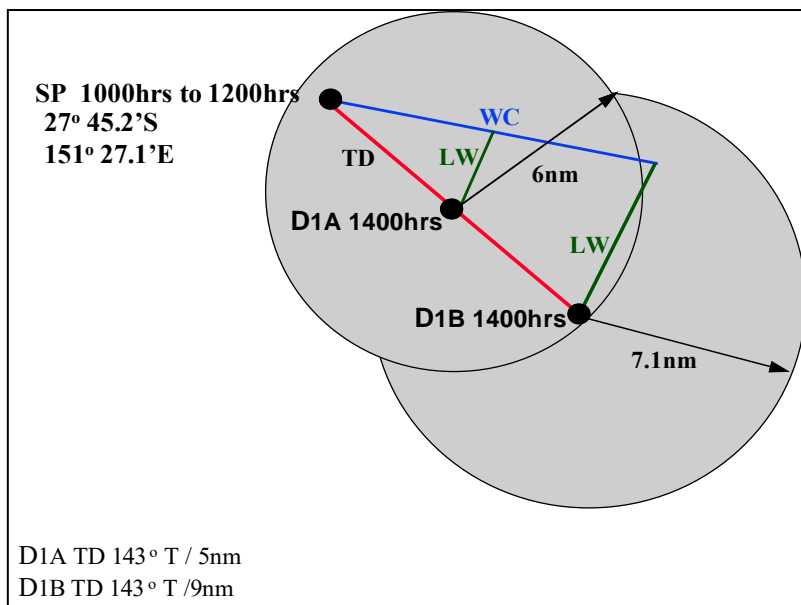

Diagram 25

9. Once the circles are drawn, the area should be boxed, with the sides of the box touching the edges of the circles (tangential), and oriented in the direction of drift. This errs on the side of safety by building in a greater safety margin. See Diagram 26 below.

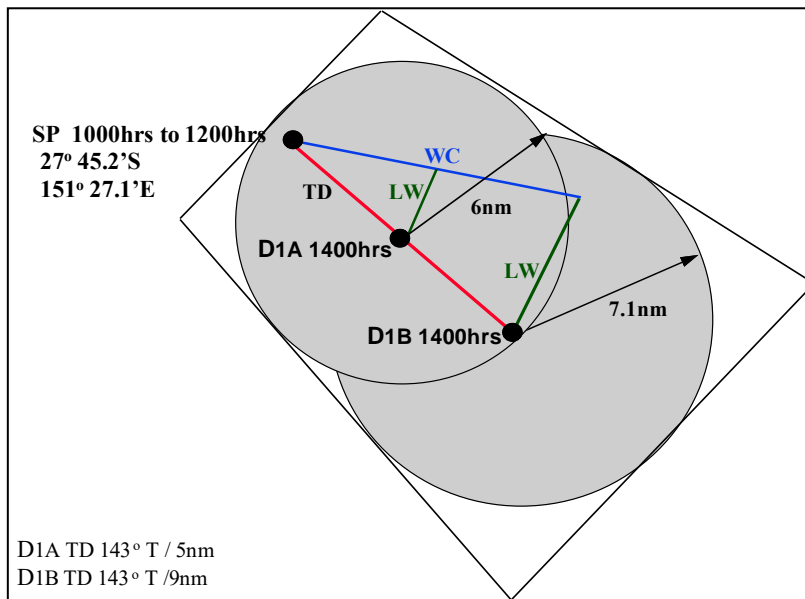

Diagram 26

10. Assuming that the length of the TD line is less than 8nm in length for both SP to D1A and SP to D1B, then a 6nm radius circle is drawn centred on both datum's, as indicated in Diagram 27 below.

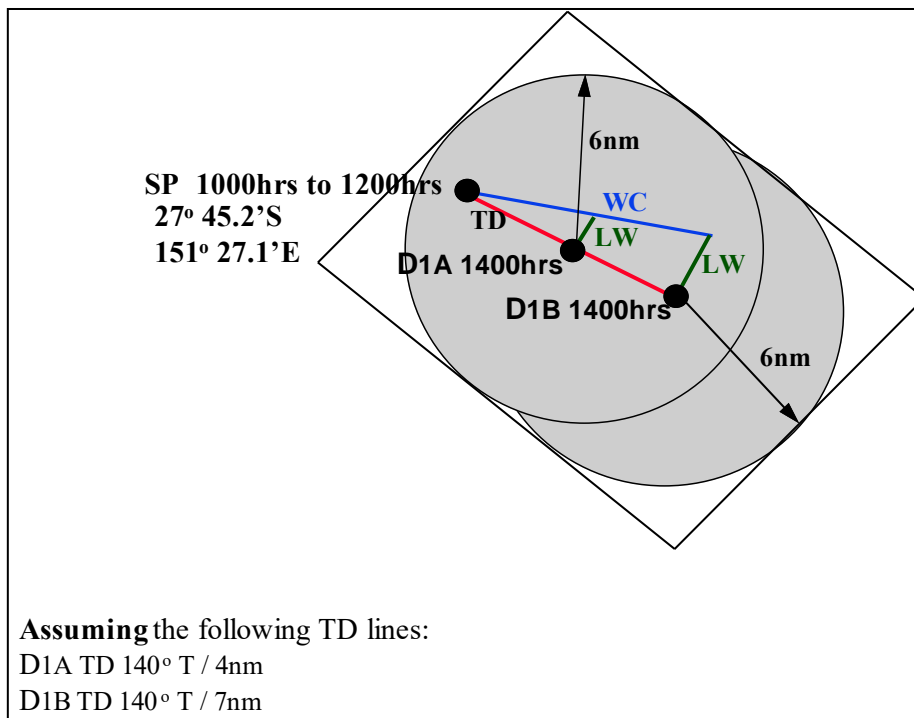

Diagram 27

Track Line Overdue

This is the most complex of all the datum SAR planning models. It is used when the track of the target is known

Datum should be calculated for a time when the search assets are likely to be on scene. There is no point in calculating datum if there are no resources in place to commence a search.

In the Trackline Overdue model, the departure point and arrival points are SPs. Along the target's intended track the Co-ordinator may need to incorporate arbitrary turn points (e.g. to go around headlands etc.), there is no limit on the number of arbitrary turn points that can be incorporated into this model. See Diagram 28 below.

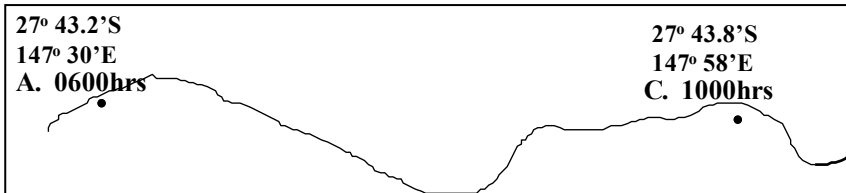

Diagram 28

For the purpose of this user guide the following example, with critical information, is used:

- a) **Target**
Light Displacement Cabin Cruiser (Without Drogue).
- b) **Cruise Speed**
The vessel's approximate speed in this case is 8 knots.
- c) **Current**
192°T at 1 knot
- d) **Wind**
318°T at 10 knots
- e) **Splash Point**
Departure Point A - 27° 43.2' S 147° 30' E at 0600hrs.
Arbitrary Turn Point B - 27° 43.5' S 147° 00' E at 0800hrs.
Arrival Point C - 27° 43.8' S 147° 58' E at 1000hrs.
In this case with a speed of 8 knots - Point A to B is 16nm and Point B to C is 16nm.
- d) **Calculate a Datum for 1200hrs**

Note:

- i. measure the route;
- ii. divide the distance by the vessel's approximate speed;
- iii. this will give the approximate time at the arbitrary turn point(s); and
- iv. this will also assist in confirming the intended arrival time.

Step-By-Step Guide

1. Do the calculations for each point separately. The points will need to be plotted. The chart and the distance of not only the intended track needs to be measured, but also the distance between each point.

If the time of departure and anticipated time of arrival can be ascertained then the approximate speed of the vessel can be calculated. If not the cruising speed of the vessel will need to be estimated, taking into account the sea conditions, vessel type and power unit on board.

In this example the target departed Point A at 0600hrs and was supposed to have arrived at Point C at 1000hrs. Because there is a headland between Points A and C the target will have needed to have adjusted course on its intended track. Point B has been arbitrarily selected (it is a safe distance off the headland and one the target's skipper is likely to have taken).

The distance A to B to C has been measured and the target's cruise speed has been estimated. Based on the estimated cruise speed of the vessel, it would have reached Point B at 0800hrs.

- a) Position A - point of departure at 0600hrs (calculate to datum time of 1200hrs)
 - i) 0600hrs to 1200hrs = 6hrs
 - ii) WC 1kn x 6hrs = 6nm
 - iii) LW .74kn per hr x 6hrs = 4.44nm
- b) Position B - arbitrary turn point at 0800hrs (calculate to datum time of 1200hrs)
 - i) 0800hrs to 1200hrs = 4hrs
 - ii) WC 1kn x 4hrs = 4nm
 - iii) LW .74kn per hr x 4hrs = 2.96nm
- c) Position C - arrival point at 1000hrs (calculate to datum time of 1200hrs)
 - i) 1000hrs to 1200hrs = 2hrs
 - ii) WC 1kn x 2hrs = 2nm
 - iii) LW .74kn per hr x 2hrs = 1.48nm

Calculations for the example based on the following:

- a) WC 192°T at 1 knot per hour multiplied by the number of hours adrift.
- b) Wind 318°T at 10 knots.

Using the Formula $[(0.07 \times 10\text{kn}) + 0.04] = .74\text{nm per hr}$ multiplied by the number of hours adrift.

2. Points A, B and C have been plotted on the chart and the intended track drawn in. It is important to check to see whether there is an opportunity for the target to have anchored, sought shelter in ports or taken made any likely deviations from the intended course (e.g. to visit a scenic island or beach) etc. See diagram 29 below.

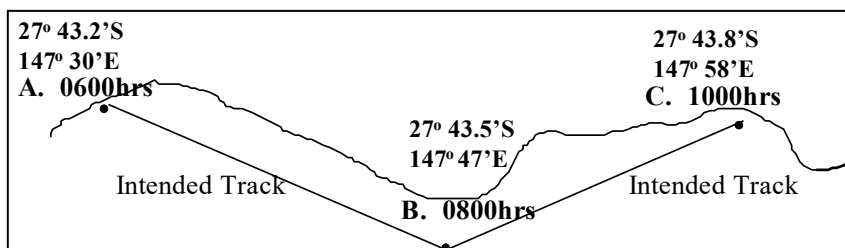

Diagram 29

Appendices

- Once both the WC and both LW legs have been plotted for the first datum, draw a line from SP to D1A. The name of the line is called the 'Total Drift' or 'Resultant'. Indicate the direction of travel with an arrowhead in the centre of the line. Note the bearing and distance of the TD line. See Diagram 30 below.

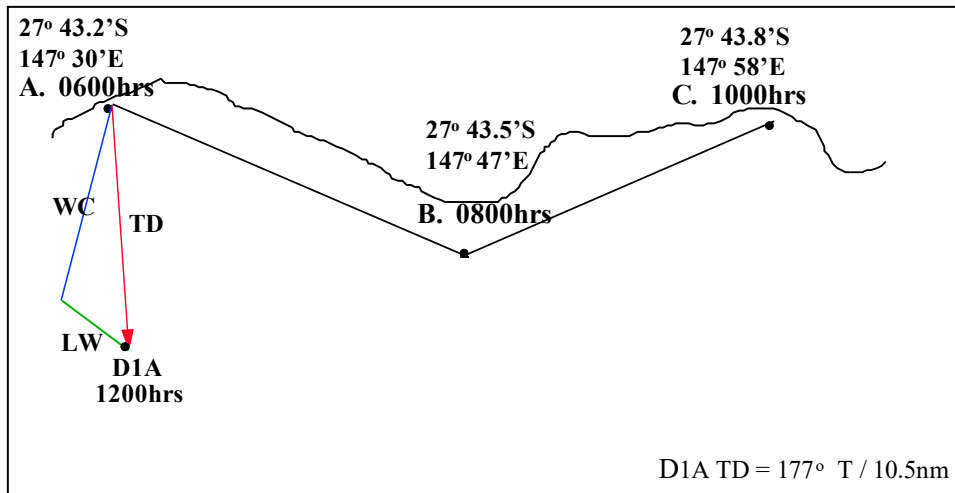

Diagram 30

- Once both the WC and both LW legs have been plotted for the second datum, draw a line from SP to D1B. The name of the line is called the 'Total Drift' or 'Resultant'. Indicate the direction of travel with an arrowhead in the centre of the line. Note the bearing and distance of the TD line. See Diagram 31 below.

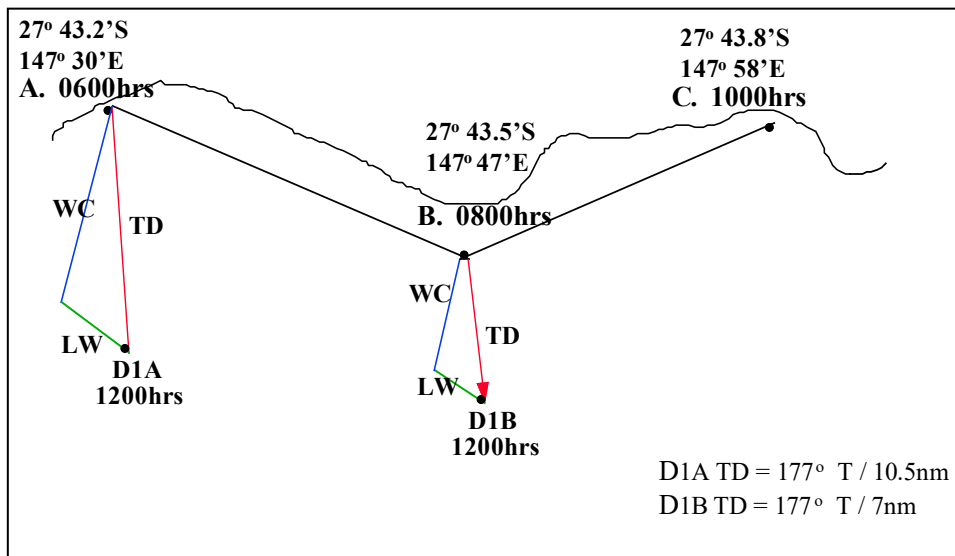

Diagram 31

- Once both the WC and both LW legs have been plotted for the third datum, draw a line from SP to D1C. The name of the line is called the 'Total Drift' or 'Resultant'. Indicate the direction of travel with an arrowhead in the centre of the line. Note the bearing and distance of the TD line. See Diagram 32 below.

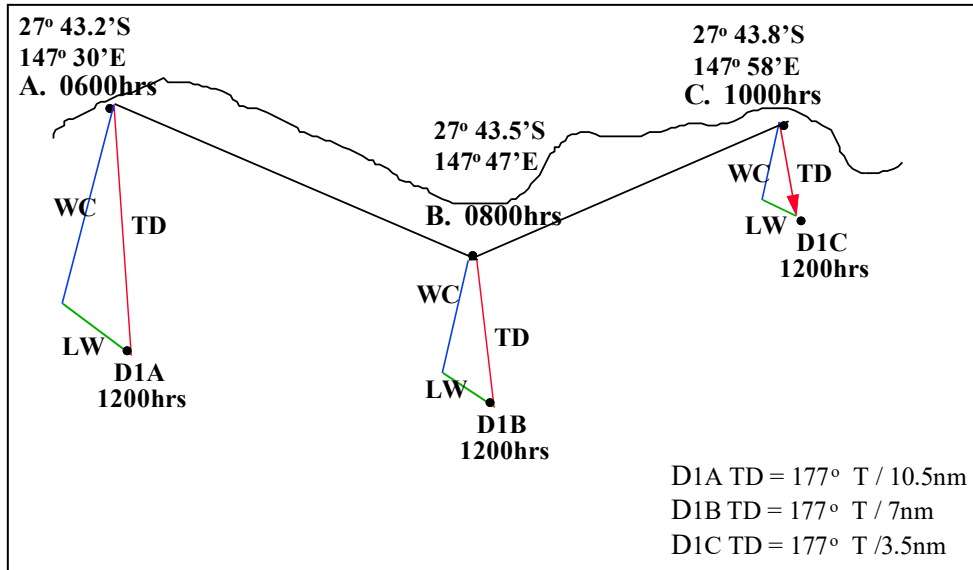

Diagram 32

- Once all three datum's have been plotted, draw a line connecting all three datum points. The name of the line is called the 'Datum Line'. See Diagram 33 below.

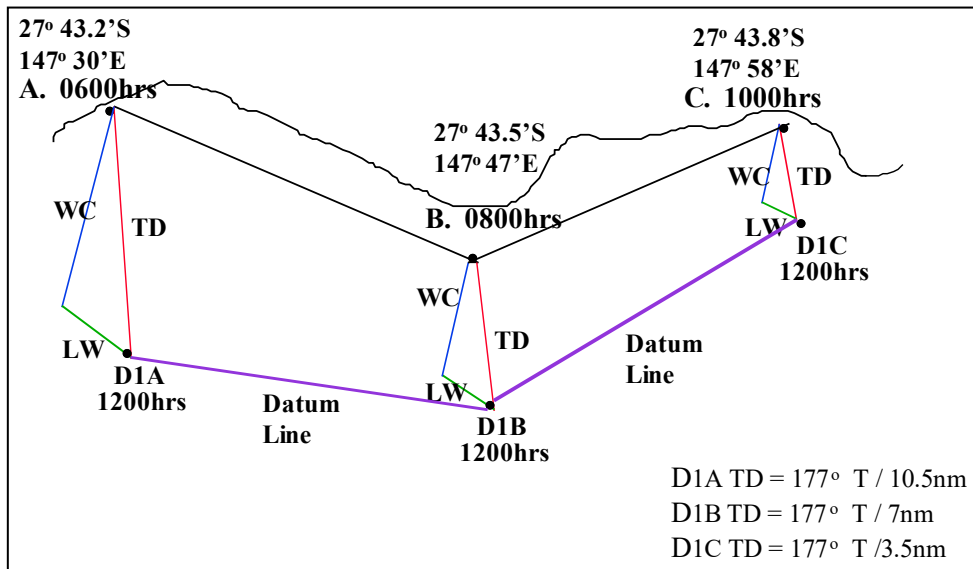

Diagram 33

7. A circle is drawn centred on datum (a 6nm radius circle is used if the TD line is less than 8nm in length). In this case the TD line between SP A and D1A is 10.5nm. Therefore the individual drift error must be applied, $10.5 \div 8 = 1.3125$. The radius of the circle drawn centred on D1A is $6 + 1.3 = 7.3$ nm. As indicated in Diagram 34 below.

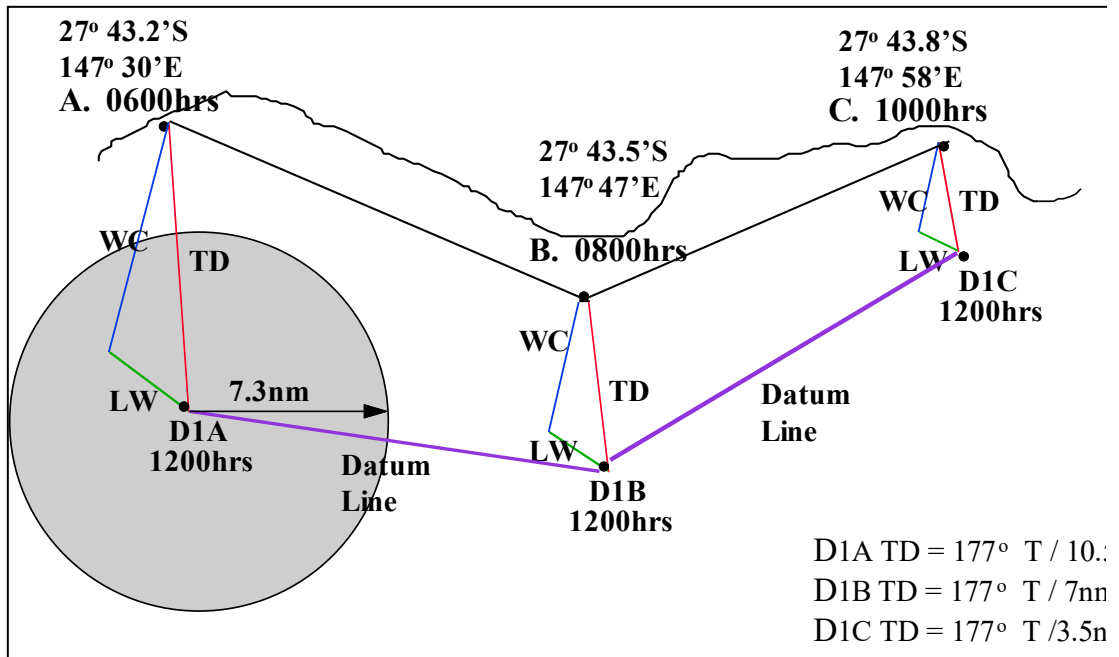

Diagram 34

8. The length of the TD line between SP B and D1B is 7nm in length, therefore individual drift error does not apply. A 6nm radius circle is drawn centred on datum D1B. See Diagram 35 below.

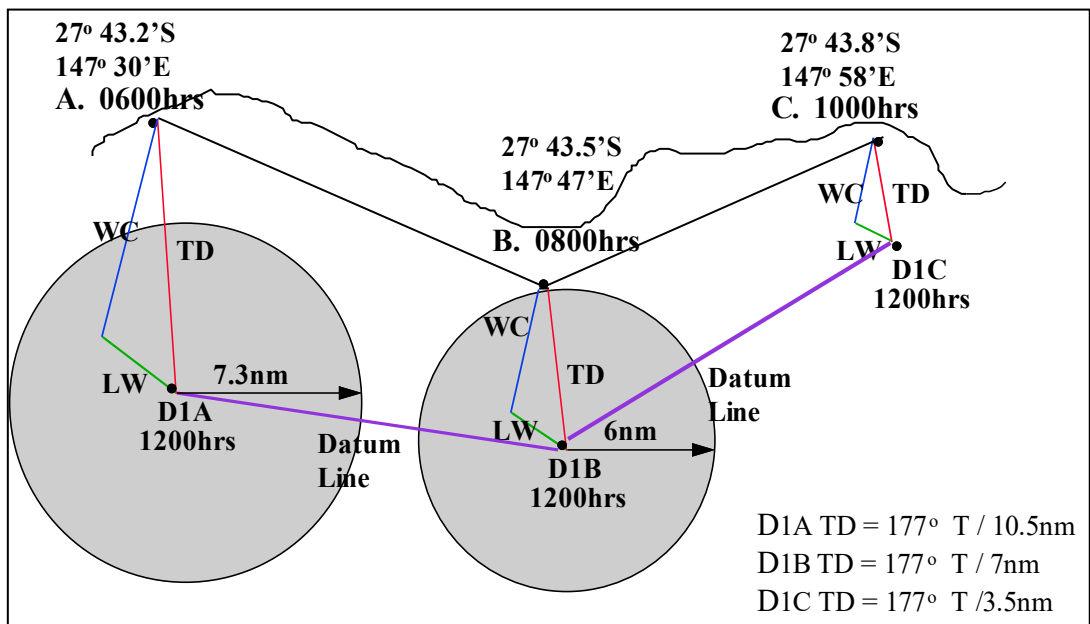

Diagram 35

9. The length of the TD line between SP C and D1C is 3.5nm in length, therefore individual drift error does not apply. A 6nm radius circle is drawn centred on datum D1C. See Diagram 36 below.

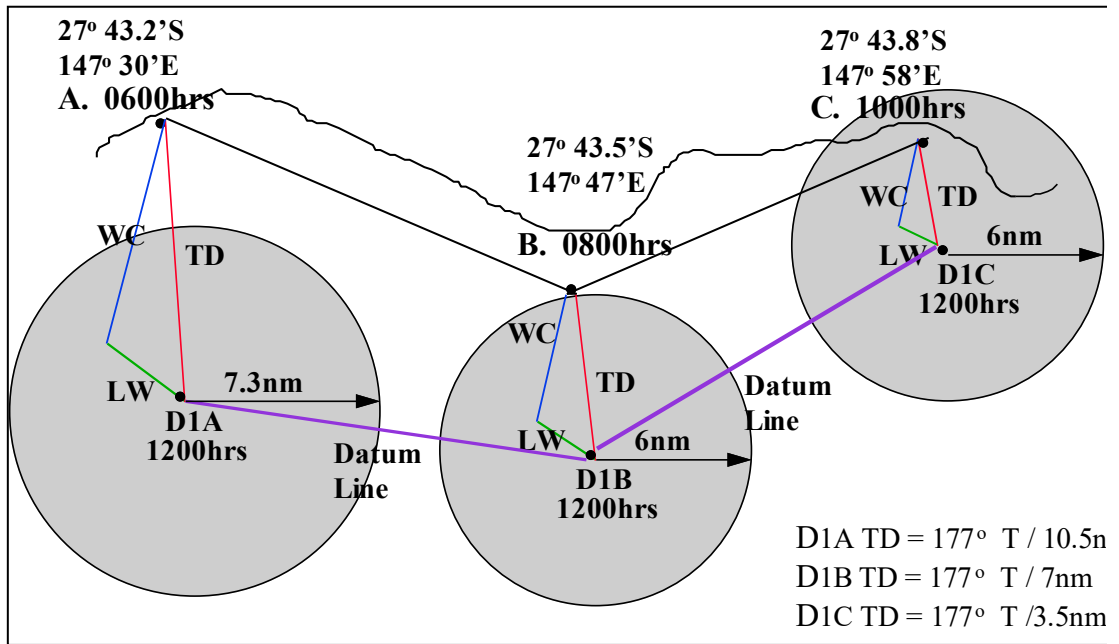

Diagram 36

10. Once the circles are drawn, the area should be boxed, with the sides of the box touching the edges of the circles (tangential), and oriented in the direction of drift. This errs on the side of safety by building in a greater safety margin. See Diagram 37 below.

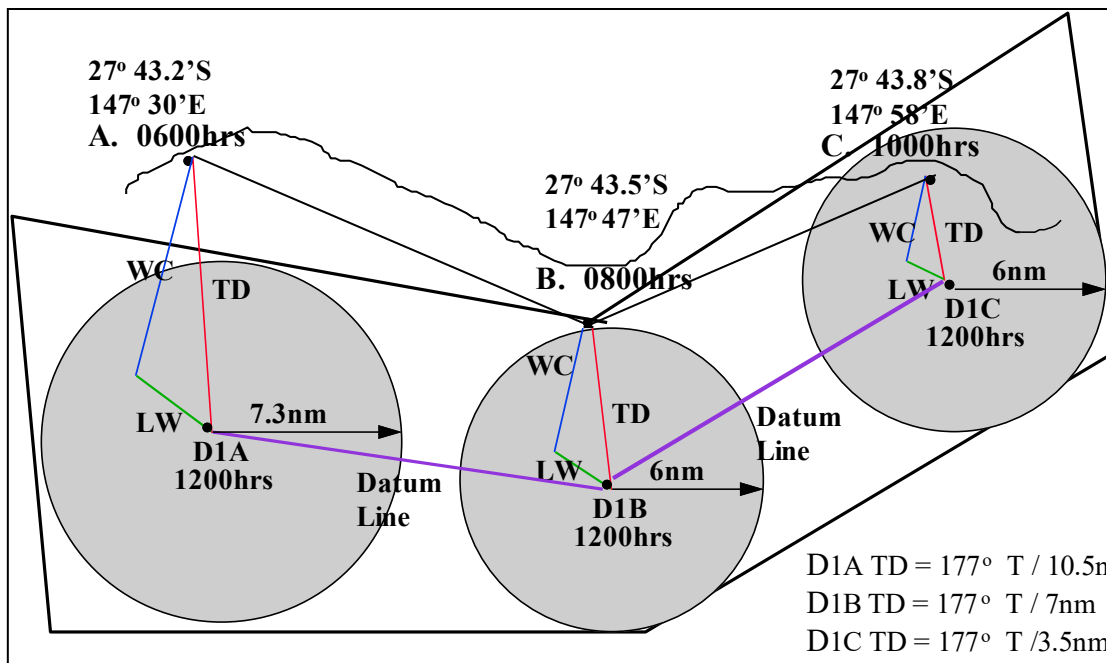

Diagram 37

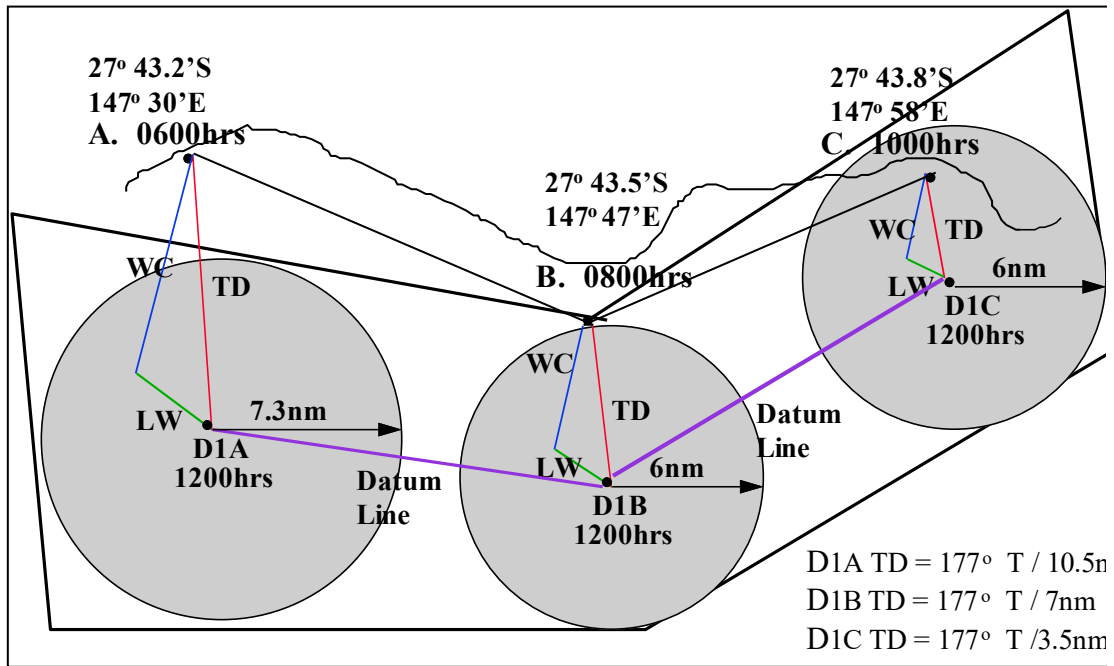

Diagram 38

11. The shaded area in Diagram 38 on the next page, is the area of high probability. It does not mean that you can discount areas outside of this initial search area.

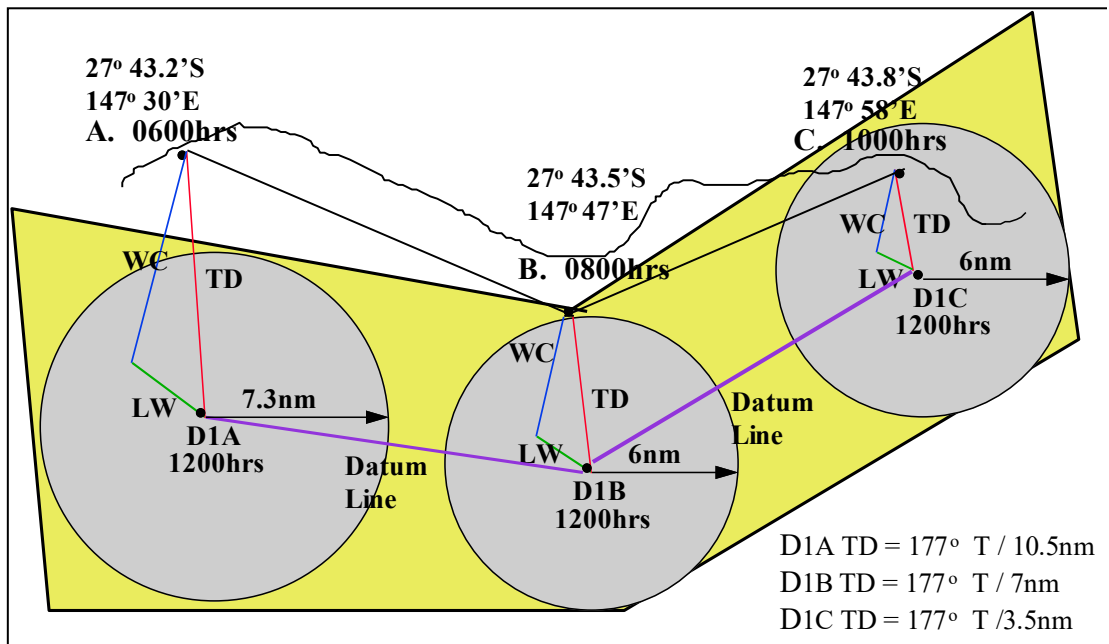

Diagram 39

12. There may cases where the area to be searched may need to be 'stretched'. Diagram 39 below gives such an example where the search area has been stretched back to the mainland. At one end of the search area the foreshores are covered, at the other end they are not, but are close enough that they should be searched.

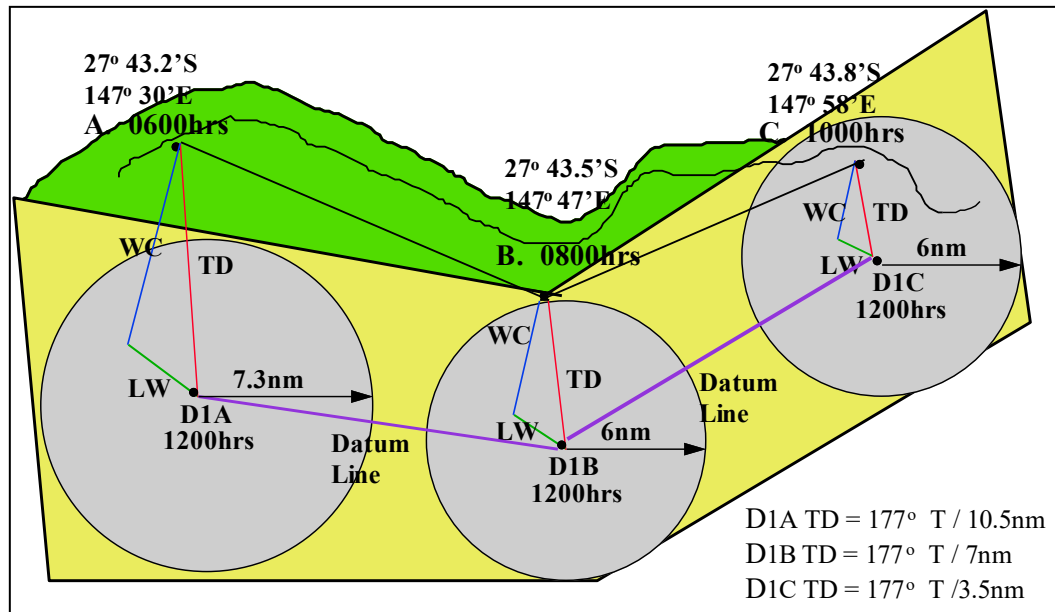

Diagram 40

13. In some cases it may be necessary to draw a 6nm radius circle centred on each on each SP. Especially where there are confused currents, water flows, eddies around reefs, islands or there is intelligence that indicates that there is a possibility that the target may be taken out the back of the search area. See Diagram 40 below.

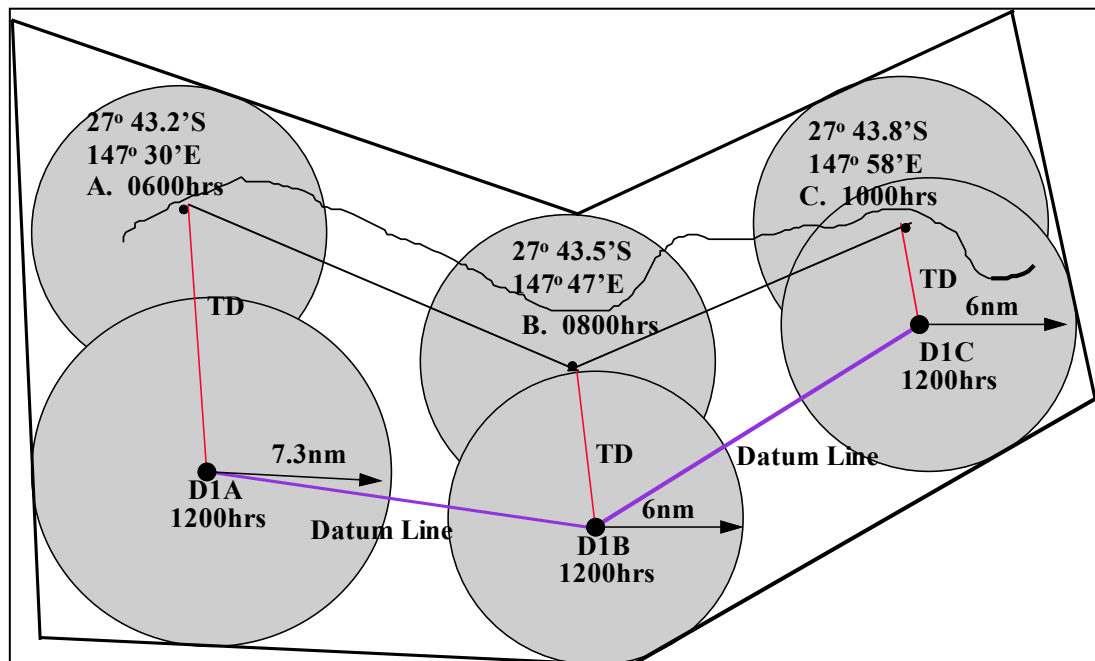

Diagram 41

13. Assuming that the length of the TD line is less than 8nm in length for SP A to D1A, SP B to D1B and SP C to D1C then a 6nm radius circle is drawn centred on all datum's, as indicated in Diagram 41 below.

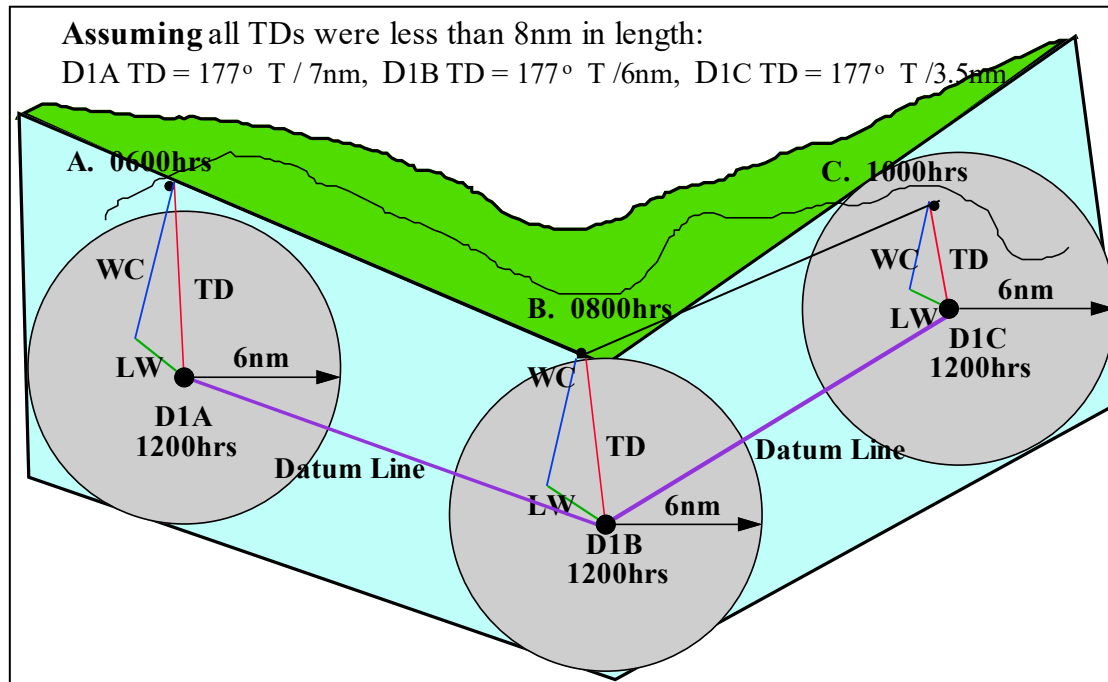

Diagram 42

Multiple Winds

This model is used when the water current is consistent yet the wind direction and velocity may have varied between the time the target got into trouble and the time datum is calculated for.

Datum should be calculated for a time when the search assets are likely to be on scene. There is no point in calculating datum for a specific time, if there will be no resources in place to commence a search at this time.

For the purpose of this user guide the following example, with critical information, is used:

- a) **Target**
Light Displacement Cabin Cruiser (Without Drogue).
- b) **Current (WC)**
1 knots South Easterly (towards the S.E.)
 135° T at 1kn per hour. $1\text{kns} \times 3\text{hrs} = 3\text{nm}$ for the water current leg
- c) **Wind**
Varied (see diagram 1 below)
- d) **Splash Point**
 $27^\circ 31.5' \text{ S } 147^\circ 30' \text{ E}$ at 1300hrs
- e) **Calculate a Datum for 1600hrs**
The search will commence at this time
- f) **Wind**
To calculate the leeway applicable to the target: $0.07U + 0.04 = \text{the rate (kts)}$.
- g) **Total hours adrift**
3 hours

Step-By-Step Guide

1. The table in diagram 42 below has been designed to assist SAR trained personnel to calculate the various legs to plot in datum SAR planning. The form is split into two components, Leeway (LW) and Water Current (WC).

Leeway component of the form

Wind Times - From - To	Enter here the time the wind starts to the time it shifts. Thereby showing a period of time for a wind blowing from a given direction. Can also be used where the wind is blowing at a relatively constant speed for a given period of time and then increases for another period of time to a higher relatively constant speed. Two entries can be made.
Wind Direc / Speed	Show here the direction wind is blowing from and the speed in knots.
Leeway direction + 180°	Add 180° to the wind direction in the previous column. This will give you the vector to plot. Remember there can only be 360° in a circle (obvious, but mistakes can be made).
Leeway rate per hr	By using the Leeway Tables. Calculate the leeway speed (kns) per hour and enter in this column.
Time interval	Referring to "Wind Times -From - To" calculate the period of time the wind had been blowing in hours and decimals of an hour for this particular entry.
Vector to plot	Enter the direction calculated in column "Leeway direction + 180°". Then multiply the "Leeway rate per hr" by the "Time interval". The result, is the amount of leeway effect caused by this period of wind for that specific period of time.

Current

Time - From - To	Enter here the time the water current starts to affect the target to the time it shifts. Thereby showing a period of time for a current setting towards a given direction. Can also be used where the current is at a relatively constant speed for a given period of time and then increases for another period of time to a higher relatively constant speed or changes direction. Two entries can be made.
Direction/Speed	Calculate the water current direction and speed (kts) per hour and enter in this column.
Time interval	Referring to "Time -From - To" calculate the period of time the current has been flowing in hours and decimals of an hour for this particular entry.
Vector to plot	Enter the direction calculated in column "Direction/Speed". Then multiply the speed of the current by the "Time interval". The result, is the amount of current effect caused by this period of current flow for that specific period of time.

Appendices

Leeway (Formula $0.07U+0.04$)

Wind Times From	Wind Times To	Wind Direc / Speed	Leeway direction +180	Leeway rate per hr	Time interval	Vector to plot
1300	1330	280° / 18	100°	1.3	.5	100° / .65nm
1330	1500	250° / 20	070°	1.44	1.5	070° / 2.16nm
1500	1600	230° / 20	050°	1.44	1.0	050° / 1.44nm

Current

Time From	Time To	Direction/Speed	Time Interval	Vector to plot
1300	1600	135° / 1	3	135° / 3nm

Diagram 42

- Plot the Splash Point (SP) on the chart, and notate as shown below in diagram 2. Splash point can also be known as Last Known Position (LKP) or Initial Planning Position (IPP). Plot the Water Current (WC) leg first.

Plot the Leeway legs (LW) second. These legs commence at the end of the WC leg. See Diagram 43 below.

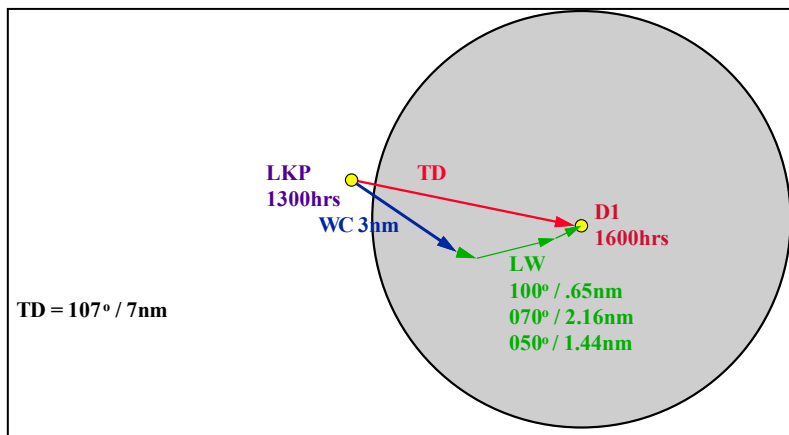

Diagram 43

- Once the circle is drawn, the area should be boxed, with the sides of the box touching the edges of the circle (tangential), and oriented in the direction of drift. This errs on the side of safety by building in a greater safety margin.

Multiple Current and Winds

This model is used when the water current and wind direction/velocity may have varied between the time the target got into trouble and the time datum is calculated for.

For the purpose of this user guide the following example, with critical information, is used:

- a) **Target**
Light Displacement Cabin Cruiser (Without Drogue).
- b) **Current (WC)**
1 knots South Easterly (towards the S.E.)
135° T at 1kn per hour. 1kns x 3hrs = 3nm for the water current leg
- c) **Wind**
Varied (see diagram 1 below)
- d) **Splash Point**
27° 31.5' S 147° 30' E at 1300hrs
- e) **Calculate a Datum for 1600hrs**
The search will commence at this time
- f) **Wind**
To calculate the leeway applicable to the target: $[(0.07U) + 0.04] = \text{kts.}$
- g) **Total hours adrift**
3 hours

Step-By-Step Guide

1. The table in diagram 44 below has been designed to assist SAR trained police officers to calculate the various legs to plot in datum SAR planning. The form is split into two components, Leeway (LW) and Water Current (WC).

Leeway component of the form

Wind Times - From - To	Enter here the time the wind starts to the time it shifts. Thereby showing a period of time for a wind blowing from a given direction. Can also be used where the wind is blowing at a relatively constant speed for a given period of time and then increases for another period of time to a higher relatively constant speed. Two entries can be made.
Wind Direc / Speed	Show here the direction wind is blowing from and the speed in knots.
Leeway direction + 180°	Add 180° to the wind direction in the previous column. This will give you the vector to plot. Remember there can only be 360° in a circle (obvious, but mistakes can be made).
Leeway rate per hr	By using the Leeway Tables. Calculate the leeway speed enter in this column.
Time interval	Referring to "Wind Times -From - To" calculate the period of time the wind had been blowing in hours and decimals of an hour for this particular entry.
Vector to plot	Enter the direction calculated in column "Leeway direction + 180°". Then multiply the "Leeway rate per hr" by the "Time interval". The result, is the amount of leeway effect caused by this period of wind for that specific period of time.

Appendices

Current

Time - From - To	Enter here the time the water current starts to affect the target to the time it shifts. Thereby showing a period of time for a current setting towards a given direction. Can also be used where the current is at a relatively constant speed for a given period of time and then increases for another period of time to a higher relatively constant speed or changes direction. Two entries can be made.
Direction/Speed	Calculate the water current direction and speed per hour and enter in this column.
Time interval	Referring to "Time -From - To" calculate the period of time the current has been flowing in hours and decimals of an hour for this particular entry.
Vector to plot	Enter the direction calculated in column "Direction/Speed". Then multiply the speed of the current by the "Time interval". The result, is the amount of current effect caused by this period of current flow for that specific period of time.

Leeway (Formula $0.07U+0.04$)

Wind Times From	Wind Times To	Wind Direc / Speed	Leeway direction +180	Leeway rate per hr	Time interval	Vector to plot
1300	1330	280° / 18	100°	1.3	.5	100° / .65nm
1330	1500	250° / 20	070°	1.44	1.5	070° / 2.16nm
1500	1600	230° / 20	050°	1.44	1.0	050° / 1.44nm

Current

Time		Direction/Speed	Time Interval	Vector to plot
From	To			
1300	1400	135° / 1	1	135° / 1nm
1400	1600	150° / 1	2	150° / 2nm

Diagram 44

- Plot the Splash Point (SP) on the chart, and notate as shown below in diagram 2. Splash point can also be known as Last Known Position (LKP) or Initial Position (IP). Plot the Water Current (WC) legs first. The reason for this is that if there is a possibility that the target is a person in the water, then the end of the WC legs becomes datum (D1).

Plot the Leeway legs (LW) second. These legs commence at the end of the last WC leg. See Diagram 45 below.

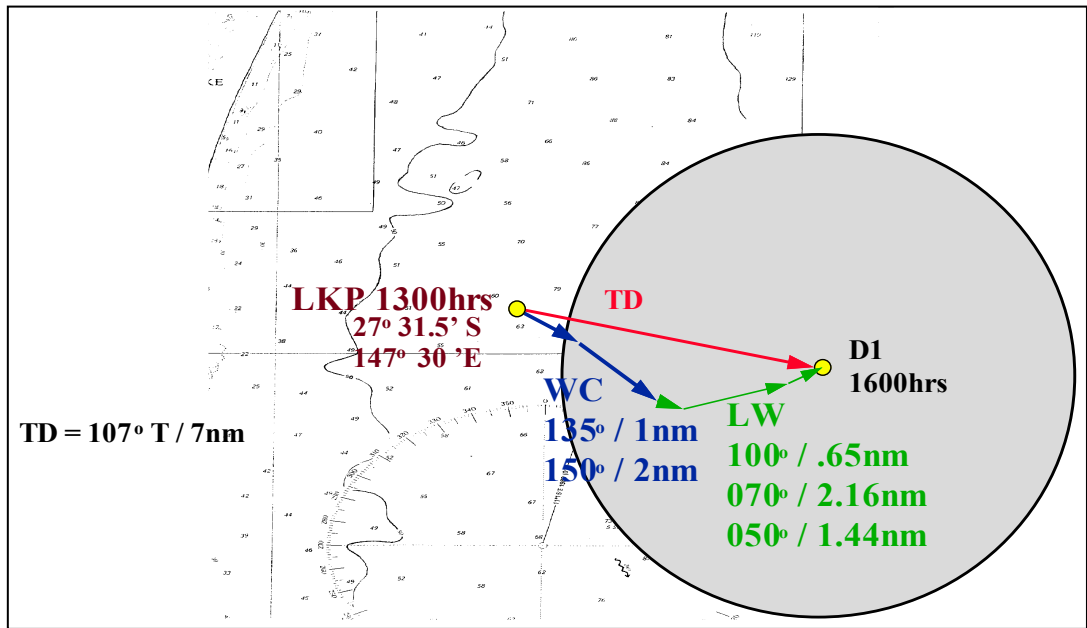

Diagram 45

3. Once the circle is drawn, the area should be boxed, with the sides of the box touching the edges of the circle (tangential), and oriented in the direction of drift. This errs on the side of safety by building in a greater safety margin.

Appendix E

Overview

Appendix E includes the following:

- Appendix E-1 Search Urgency Form
- Appendix E-2 Missing Persons Questionnaire
- Appendix E-3 Object Questionnaire
- Appendix E-4 Land SAR Checklist
- Appendix E-5 Lost Person Behaviour
- Appendix E-6 Land Search Planning Tables
- Appendix E-7 Additions to Naismith's Rule
- Appendix E-8 Probability of Detection (Land)
- Appendix E-9 Mattson Consensus
- Appendix E-10 Land SAR Organisation Chart
- Appendix E-11 FSH Layout
- Appendix E-12 Search Communication Network
- Appendix E-13 Clue Recognition
- Appendix E-14 SAR Tasking Sheet
- Appendix E-15 Search for Skeletal Remains
- Appendix E-16 Peer Review
- Appendix E-17 Body Flotation Information

Appendix E-1 Search Urgency Assessment Form

Search Urgency Assessment

Name of Incident:		No:	
Date Completed:	Time completed:	Initials:	Incident date:
Number of subjects			
1 person		1	
2 people or 3 or more –separated		2	
3 people or more – together		3	
Age			
Very young		1	
Other		2-4	
Very Old		1	
Medical Condition			
Known illness or requires medication		1	
Suspected illness or injury		1	
Healthy		3	
Known frailty		1	
Potential vision impairment		1	
Intent			
Suicidal		1	
No known intent		3	
Absconder from facility		4	
Cognitive Capacity			
Dementia / Alzheimer's /Parkinson's		1	
Capacity of 16-year-old or less		1	
Diagnosed mental illness, depression or anxiety		2	
No known capacity issues		3	
Experience profile			
Not experienced, not familiar with area		1	
Not experienced – familiar with area		2	
Experienced – not familiar with area		3	
Experienced – familiar with area		4	
Physical Condition			
Unfit		1	
Fit		2	
Very fit		3	
Clothing profile			
Inadequate/insufficient		1	
Adequate		2	
Very good		3	
Equipment Profile			
Inadequate for activity/environment		1	
Questionable		2	
Adequate		3	
Very Well equipped		4	
Weather profile			
Existing Hazardous weather		1	
Hazardous forecast (8 hours or less)		2	
Hazardous forecast (more than 8 hours)		3	
No hazardous weather forecast		4	
Terrain and Hazards profile			
Known hazards		1	
Difficult terrain		2	
Few hazards		3	
Easy terrain, no known hazards		4	
11-17 Emergency Response	18-27 Measured response	28-40 Evaluate & Investigate	
Note: If any individual category above is rated as ONE (1) , regardless of its total – the search could require an emergency response			
Remember: the lower the number the more urgent the response!!!			

Appendices

NATIONAL SEARCH AND RESCUE MANUAL

2023 EDITION Version 1 – February 2023

Appendix E-2 Missing Person Questionnaire

Missing Person Questionnaire									
Incident:				Date:			Time:		
Surname:					Given names:				
Address:						Telephone:			
						Mobile:			
DOB:				Ethnicity:			Sex:		
NOK:						Telephone:			
Hgt:	Wgt:	Bld:	Eyes:	Cmp:	Beard:	Scars:	Hair:	Lgth:	
Hiker Exp:			Climber Exp:			Swim Exp:			
Snow Exp:			Military Exp:			Camping Exp:			
First Aid Trn:			Map/Compass Trn:			Knowledge of area:			
Smoke:		Drink:		Fears:		Lost before:		Action then:	
Shirt:		Jumper:		Trousers:		Jacket:		Raingear: Hat:	
Shoes:		Sole pattern:		Scarf:		Glasses:		Watch: Jewellery:	
Other Clothing:						Clothes for dog scent:			
Pack:		Colour:		Tent:		Colour:		Slp Bag: Colour:	
Water Bottle:		Colour:		Torch:		Colour:		Slp mat: Colour:	
Knife:		Matches:		Compass:		Firearm:		Fishing gear: Camera:	
Ropes:		Climb Equ:		Kayak:		Radio AM:		Radio CB: PLB:	
Map:					Food:				
Name:		Scale:		Number:					
Vehicle Reg No:				Make/Model:			Colour:		
Medical History:				Physical Problems:			Psych Problems:		
Medication:				Amount carried:			Consequences:		
Doctor:				Address:			Telephone:		
Family Problems: (Financial, family)					Request for Aid (Welfare)				
Person to notify if found ALIVE:				Address:			Telephone:		
Person to notify if found DEAD:				Address:			Telephone:		
Remarks:									
Name:					Rank:		Station:		

Appendix E-3 Object Questionnaire

Object Questionnaire			
SAR Number:		Date/Time:	
Description of Object: (If photo/drawing is available please attach)			
Make:	Model:	Reg/Serial No:	
Colour:	Dimensions:	Weight:	
Special Markings/Identifiers:			
Does this object pose any dangers to humans, animals or the environment? If so describe in detail:			
Who can be contacted to provide expert advice?			
Name:	Organisation:	Telephone Number:	Fax No:
What action is to be taken by searchers if object found?			
Information provided by:			
Name:	Organisation:	Telephone Number:	Fax No:
Remarks:			
Name:	Rank:	Section/Station:	

Appendices

Appendix E-4 Land SAR Checklist

Land SAR Checklist			
Maintain chronological action log: <i>(Who spoken to? Times, Dates)</i>			
Missing person Questionnaire:		Completed:	
Search Area:			
Terrain		Hazards	
Communications		Assessment of scenarios	
Availability of resources		What's been done to date	
Isolate/Contain area		Local SAR Plan	
Weather (www.bom.com.au)			
At present		Forecast	
Sunset/sunrise		Potential hazardous weather	
Search Urgency			
Complete Search Urgency Form		Determine appropriate response	
Update briefing to Insp/Sen Sgt/Duty Officer		Update JRCC	
Advise Media Section		Advise Coroner (If death)	
Advise SES and other resources			
Field Search Headquarters			
Set up Field Search Headquarters		Suitable location	
Access		Parking	
Transport		Communications	
Facilities		Equipment	
Missing Person Locations			
Confirm Initial Planning Point IPP		Last Known Point LKP	
Point Last Seen PLS			
Lost Person behaviour LPB			
Establish distances		Characteristics	
Likely search areas		Medical considerations	
TFFS		POM	
Mapping			
Suitable maps		Mark IPP, LKP, PLS	
Areas searched		Areas to be searched	
SITREPS:			
To local command		SAR Command	
OIC		Media	
NOK		Other agencies	
Planning:			
Identify Operations Commander (Liaise with same)		Identify SMC	
Search appreciation conducted		Designate sub roles	
A/SMC		Planning member	
Intelligence member		Log keeper	
Communications member		Logistics member	
Consider Criminal Investigation Branch if suspicious		NOK Liaison officer	

Land SAR Checklist			
Establish White Board		Establish Communications Plan	
Updated weather information		Mapping/tasking	
Identify search areas (Manageable in 4-6hrs)		Consider Mattson Consensus	
Allocate Operational periods for future taskings		Rescue Plan	
Allocate resources to teams		Brief Search Personnel	
Team leader Briefings			
SMEAC		Emphasise clues	
Calling method		Description/clothing	
Search method		SITREP requirements	
Questions? Understood		Rescue Plan	
Actions on			
Search patterns			
FAST Teams		Static Teams (SES Light trailer)	
Road Blocks		Patrols	
Track Traps		Broad Sweeps	
Sound Sweeps		Night Search	
Contact Search		Line (Parallel) Search	
Records			
Action log		Equipment issued log	
Radio log		Search team records	
Personnel records- Attendances		Intelligence Records	
Update Map/Chart/white boards		Daily summary of personnel	
Debrief			
Thoroughness of search		POD	
Mark searched areas on map		Team leader to sign search record	
Clues		Further areas to search	
Issues raised		Download GPS information	
Manage welfare			
Future Issues			
Allocate time callout for more resources		Search/rescue plans	
Evacuation plan		Operational periods	
Change over of staff/SMC		Equipment/fuel	
Conclusion of SAR Operations -			
<i>At the conclusion of a SAR operation due to a target being located or the operation is suspended when a target is not located, the designated SMC should consider the following points and determine the correct course of action.</i>			
Confirm information is accurate and target has been located			<input type="checkbox"/>
Alert all SRU – Stand down units			<input type="checkbox"/>
Sign in all members and document any injuries			<input type="checkbox"/>
All appropriate agencies notified			<input type="checkbox"/>
Sitrep to local command			<input type="checkbox"/>
Log assets / resources <i>Equipment repair & return</i>			<input type="checkbox"/>

Appendices

Land SAR Checklist	
NOK Notified <i>Insure they are updated regularly.</i> <i>Appoint a liaison member</i> <i>Ensure active participation in process were possible</i> <i>Prepare NOK for suspension decision at least one day prior</i>	<input type="checkbox"/>
Consider bringing in coroner or coroner's assistant	<input type="checkbox"/>
Involve Police Investigators early - If M/P not located	<input type="checkbox"/>
Consult Doctor – private and independent	<input type="checkbox"/>
Media release <i>Ensure you communicate correct message if SAR suspended.</i> <i>Seek advise from Police Media liaison unit</i> <i>Consider signs or pamphlets left in area – if target not located</i>	<input type="checkbox"/>
Debrief the MP – document / consider taping	<input type="checkbox"/>
Review who has command – If SMC leaving area	<input type="checkbox"/>
Hazards I.D eg. abandoned vessel – advised shipping	<input type="checkbox"/>
Records collated and filed	<input type="checkbox"/>
If target not located – Document reasons for suspension <i>Document by - police statement or Specific suspension of SAR documentation</i> <i>Signed off by district officer or higher</i>	<input type="checkbox"/>
Administration / Financial procedures completed	<input type="checkbox"/>
Conduct & organize debriefs – Hot & Full	<input type="checkbox"/>
Ensure Debriefs documented – Action items identified <i>Improvements, what went well, further investigation, encourage feedback</i> <i>Designate actions items to specific members</i> <i>Full debrief with relevant team leaders within 2 weeks of conclusion</i>	<input type="checkbox"/>
Safety issues after search. Driving whilst tired / alcohol	<input type="checkbox"/>
Consider critical incident stress management issues	<input type="checkbox"/>
Letters of thanks to outside agencies <i>Certificates for good work</i>	<input type="checkbox"/>
Conduct review – conclusion or suspension of SAR operation <i>By SMC and independent member</i> <i>Examine search plan</i> <i>Review planning scenarios</i> <i>Confirm initial planning point</i> <i>Evaluated all intelligence</i> <i>Examine all calculations</i> <i>Consult other experts – Police/medical/JRCC</i> <i>Review TFFS with all available information</i> <i>Quality and effectiveness of search</i> <i>Consult doctor - personnel and independent</i> <i>Coverage of all areas searched</i> <i>POD high as desired</i> <i>Can you justify what has been done or not done?</i> <i>Never assume anything – information must be confirmed</i>	<input type="checkbox"/>

Land SAR Checklist

Consider – <i>Future Case study NATSAR</i> <i>Review NATSAR Manual Volume 2 Chapter 6 Conclusion of SAR Operations</i> <i>Exercises in area</i> <i>Over flights by Helicopter</i>	<input type="checkbox"/>
CONCLUSION OR SUSPENSION - NOT TERMINATION	
Resources	
JRCC	Local Police
Command Truck	Dog Squad
Mounted Unit	Radio Techs
Field Catering	Media Unit
Psychologist	Forensic Unit
Scenes of Crime Unit	JRCC
DACC	Ambulance
SES	Fire Service
Cave/Mine rescue	Salvation Army
Surf Life saving	Volunteer Marine Rescue
Coast Guard	Ski Patrol
Customs	BOM
Harbour master	

Appendix E-5 Lost Person Behaviour

Lost Person Behaviour

Lost Person Behaviour (LPB) has been derived from many studies and statistics gathering from search and rescue groups in many countries of the world. It has been found that certain categories of missing persons tend to have similar characteristics with respect to being lost. These categories have been broken down into the following groups:

- a) Children 1-3 years of age
- b) Children 4-6 years of age
- c) Children 7-12 years of age
- d) Youths 13-15 years of age
- e) Despondent or Suicide
- f) Psychological Illness
- g) Developmental Problems
- h) Alzheimer's and Dementia
- i) Hikers and Walkers
- j) Climbers
- k) Hunters
- l) Prospectors
- m) ADD, ADHD, Autism and Asperger's

Lost Person Behaviour Definitions:

Children 1-3yrs: All children aged 1-3 years of age.

Children 4-6yrs: All children aged 4-6 years of age

Children 7-12yrs: All children aged 7-12 years of age.

Youths 13-15yrs: All teens aged 13-15 years of age.

Despondent: A person feeling or showing signs of profound hopelessness, dejection, discouragement and/or gloom. This includes depression and people who have expressed the intent to commit suicide. Not all despondent people are suicidal and similarly not all suicidal persons are despondent but they have similar characteristics and are therefore combined for SAR purposes.

Psychological Illness: This category covers persons suffering from a wide range of mental disorders that medically would not be used together. They include persons suffering from schizophrenia, paranoia, psychotic disorders and bipolar disorders. These disorders can be naturally occurring or artificially induced such as by substance abuse. This category does not include dementia.

Developmental Problems: Also called Mental Retardation or Intellectual disability is a combination of below average intellectual functioning, impairments in daily life (communication, self-care, social skills, work, safety, health) and was onset prior to the age of 18 years. This category also applies to persons suffering brain injuries after 18 years that exhibit the same symptoms.

Dementia: Dementia is the loss of memory, reason, judgement and language to such extent that it interferes with daily living. Dementia includes AIDS and Alcohol related dementia, Alzheimer's disease, Down Syndrome, Early or Younger Onset Dementia, Frontotemporal Lobar Degeneration, Vascular

Dementia and Dementia with Lewy bodies. Dementia often results in severe disturbances in how a person perceives and interprets events, sights, and sounds around them.

Hikers and Walkers: This category includes day walkers, members of bush walking clubs, hill/fell walkers, multi-day hikers, trekkers, orienteers and other persons who purposefully enter the bush for recreational walking purposes. Mountaineers are included in the climbing category.

Climbers: This category includes day climbers (single day outings, bouldering, rock and cliff climbers, traditional climbers and sport climbers) and mountaineers (those who attempt prominent peaks or alpine travel).

Hunters: This category includes all forms of hunting (pigs, water buffalo, brumbies, game fowl, kangaroos, cattle) on land. There is insufficient data for a further breakdown.

Prospectors: This category includes those persons undertaking any prospecting activities, such as gold prospecting, opal hunting and all other activities of this nature.

ADD, ADHD, Autism and Asperger's: This category includes all children who have been clinically diagnosed with one of those conditions. While all subtly different in their effects the behaviour of suffering children is often comparable.

These are the most common groups of missing persons likely to be the subject of a search in Australia.

The distances contained with each category include 25%, 50%, 75%, 80% and 95%. The 25%, 50% and 75% are utilised within the PolSAR Land Search Program and may also be useful outside that context. The 80% is what is most often used to determine the initial search area. Statistically, above 80% there is often a sharp increase in distances, therefore the 80% distance represents the end of the normally expected range.

There have been numerous studies on missing person behaviour with the most recent being Robert Koester's (ISRID) International Search and Rescue Incident database www.dbs-sar.com. This study collates thousands of incidents, statistics and previous studies for an international database. This information is continually being analysed and updated with Koester, currently dividing missing person statistics to eco regions around the world that will enable more defined distances of travel for particular areas. For instance Victoria, a temperate terrain, as opposed to Northern Territory a hot dry terrain. The only Australian specific project on missing person behaviour was the SARBAYES project which was completed by Charles Twardy: <http://sarbayes.org/natsar.pdf>. The current Australian data base for the entry of LPB details is: <http://goo.gl/OLZmW>

Overseas studies also look at other categories such as hunters, skiers and miscellaneous adults. The three main LPB studies used for this manual have been taken from the UK, USA and Canada. Although Australia has many links with the UK and the majority of our citizens have a British background, we are a more mobile and active society more closely resembling Canada in our lost person behaviour. These tables have been prepared as a guide only and are a compilation of studies in the above countries. They represent the statistical properties and characteristics of missing persons and what could be expected of them when they are lost, but ultimately these are only probabilities, not certainties.

This information can be used as the basis of search planning when no other information is available. Obtaining a good profile of the target person will assist the SMC in determining whether that person/group fits into the known behavioural patterns of the various categories studied. If so, then further planning can be carried out on the information contained within this section. The SMC must always be aware that not everyone will adhere to these profiles. As can be seen in the distances travelled, 80% are within a relatively small area while the last 20% of persons in each category tend to travel much greater distances.

The studies show what the majority will do, there will always be someone outside the box who will do the opposite of what is expected.

Lost Person Behaviour Children 1-3

Characteristics: 1–3-year-old

- a. Have no concept of being lost.
- b. Navigational skills are non-existent
- c. Will wander aimlessly
- d. Will not often respond to commands or whistles.
- e. Will tend to find shelter, which increases their survivability.

Tendencies:

- a. Will often seek out a place of shelter. Thick bushes, tables, old vehicles or appliances, caves.
- b. Difficult to detect.
- c. Will rarely self-help or walk out.

Strategies:

- a. Urgent response
- b. Confinement is a low priority.
- c. Passive techniques are not often successful.
- d. Dogs may be helpful if used quickly.
- e. Checks of places of highest probability to be made initially.
- f. Teams to run main tracks and trails.
- g. May require getting down onto hands and knees to identify other less obvious tracks.

Where located statistically:

- | | | |
|----|-------------------------|-----|
| a. | Habitation | 25% |
| b. | Building/shelter | 25% |
| c. | Open ground | 25% |
| d. | Fence line, hedge, wall | 12% |
| e. | Water, water's edge | 12% |

% of category	25	50	75	80	95%
Distance from LKP (KM)	0.27	0.6	1.79	2.10	4.45

Lost Person Behaviour Children 4-6 years

Characteristics: 4–6-year-old

- a. Have an idea of being lost and will endeavour to return to home or to a familiar place.
- b. Will panic, which may cause them to become further lost.
- c. Explorations are usually one way, as a result of not comprehending to need to make a return journey.
- d. Will tend to remain on tracks or what they perceive as tracks. Not always visible to taller adults.
- e. Are considerably more mobile than smaller children.
- f. May have been following an adult or animal prior to getting lost.
- g. Most Australian children of this age have at least minimal swimming ability.

Tendencies:

- a. Will often seek out a place of shelter. Thick bushes, tables, old vehicles or appliances, caves.
- b. Difficult to detect.
- c. Will rarely self-help or walk out.

Strategies:

- a. Urgent response
- b. Confinement is a low priority.
- c. Passive techniques are not often successful (Consider nicknames).
- d. Dogs may be helpful if used quickly.
- e. Checks of places of highest probability to be made initially.
- f. Teams to run main tracks and trails.
- g. May require getting down onto hands and knees to identify other less obvious tracks.

Where located statistically:

- | | |
|------------------------|-----|
| a. Habitation | 28% |
| b. Building/shelter | 27% |
| c. Road, linear | 19% |
| d. Bush, scrub | 11% |
| e. Open ground | 8% |
| f. Water, water's edge | 7% |

% of category	25	50	75	80	95
Distance from LKP (KM)	0.33	0.95	2.12	2.57	5.47

Lost Person Behaviour Children 7-12 years

Characteristics:

- a. Have developing navigational skills.
- b. Are developing mental pictures of their environments, which are often inaccurate and highly distorted.
- c. Often become lost while attempting a short cut.
- d. Often become lost while 'role playing' or adventuring.
- e. Often become upset upon being lost and will act irrationally.
- f. May attempt to track run which can take them further from their LKP.
- g. Will act more rationally if with a friend or sibling.
- h. Will often attempt to self-help, not always successfully.

Tendencies:

- a. Will mostly stay on tracks or trails.
- b. May seek out favourite places, hideouts etc, check with friends
- c. May seek out known landmarks, lookouts, high points, places they have been to in the past, lakes, ponds, areas where vegetation changes such as forest edges.

Strategies:

- a. Urgent response
- b. Confinement is a high priority
- c. FAST and Reconnaissance teams to highest probability areas.
- d. Use dogs if available
- e. Passive techniques are not often successful.

Where located statistically:

- | | |
|------------------------|-----|
| a. Habitation | 28% |
| b. Building/shelter | 27% |
| c. Road, Linear | 19% |
| d. Forest/woods | 11% |
| e. Open ground | 8% |
| f. Water, water's edge | 7% |

% of category	25	50	75	80	95
Distance from LKP (KM)	0.65	1.98	4.57	5.15	10.2

Lost Person Behaviour Youth 13-15

Characteristics:

- a. Moderately developed navigational skills
- b. Often want to be alone.
- c. Often become lost as part of a group engaged in exploring.
- d. Don't often travel far.
- e. Often respond to attractant techniques.
- f. Often seek familiar locations by direction sampling.
- g. Will act more responsibly as part of a group.
- h. Will often attempt to self-help.
- i. May panic if alone

Tendencies:

- a. Will mostly stay on tracks or trails.
- b. May seek out favourite places, hideouts etc, check with friends
- c. May seek out known landmarks, lookouts, high points, places they have been to in the past, lakes, ponds, areas where vegetation changes such as forest edges

Strategies:

- a. Urgent response
- b. Confinement is a low priority unless MP is alone
- c. FAST and Reconnaissance teams to highest probability areas.
- d. Use dogs if available
- e. Passive techniques are not often successful.

Where located statistically:

- | | |
|----------------------------|-----|
| a. Habitation | 24% |
| b. Stream/waterway | 22% |
| c. Building/shelter | 21% |
| d. Forest/ woods | 11% |
| e. Road, Track | 11% |
| f. Forest edge or clearing | 11% |

% of category	25	50	75	80	95
Distance from LKP (KM)	1.25	2.2	4.0	4.37	14.43

Lost Person Behaviour Despondent

Characteristics:

- a. Don't often travel far, but intent to be alone
- b. Often located a border of two types of terrain and/or vegetation boundary
- c. May head for a scenic location or well-known beauty spot.
- d. Locations are often well known to MP, check with family
- e. Rarely located in dense underbrush or trees.
- f. Rarely respond to call and whistles and may hide.
- g. Very high fatality rate
- h. Drugs and/or alcohol often involved.

Tendencies:

- a. Go to high points or scenic locations.
- b. Well known or favourite places.
- c. Terrain interfaces
- d. Group 1- merely seeking to get out of sight.
- e. Group 2-will seek out a specific location, significant to their life.
- f. May travel further.

Strategies:

- a. Investigation important
- b. Obtain a good subject profile from family and friends.
- c. Urgent response
- d. Thorough search of a small area
- e. Confinement is a low priority
- f. Passive techniques not successful

Where located statistically:

- | | |
|-------------------------|-----|
| a. Habitation | 26% |
| b. Water/water's edge | 24% |
| c. Forest/woods | 16% |
| d. No trace | 13% |
| e. Road | 11% |
| f. Forest edge/clearing | 9% |

% of category	25	50	75	80	95
Distance from LKP (KM)	0.41	1.18	2.15	2.46	18.14

An increasing percentage of all persons who go missing do so with the intent of committing suicide. The reasons for this are beyond the scope of this document but are wide and varied. The SMC should consider whether the MP is genuinely at risk of taking their own lives and what strategy should be used. Studies have shown that there is a strong link between depression and suicide, although not all depressed persons consider suicide as an option. The three strongest indicators that a depressed person may contemplate suicide are:

- a) They have left a suicide note indicating their intentions of taking their own lives.
- b) They have recently talked about taking their own lives.
- c) They have acted uncharacteristically, such as tidying up their affairs, leaving their wallet, telephone and other documents behind.

The SMC needs to obtain a detailed profile of the target person. There is often something in their background that is either the cause or trigger for them to contemplate suicide. Problems to look for are:

- Relationships
- Finances
- Sexual
- Employment
- Education
- Medical
- Mental health
- Addictions

If someone who is suffering depression has indicated an intention to take their own life, and has one or more of the above triggers present, there is a high probability that the person poses a high risk of taking their own life. The risk is normally low pre-teens and increases during puberty and adolescence, reaching a peak in the mid-twenties and remaining relatively constant until old age.

Religious conviction may be an indicator of suicide intent. Strongly Christian believers are less likely to commit suicide. Those with no religious beliefs have a high tendency towards suicide. In some religions, such as Judaism, Islamic, Hindu, Shinto, suicide is a valid way to depart earth.

If there is a suicide note, the contents may provide important information regarding where and how the person intends to suicide. It may provide specific information about a favourite or known location. It may also indicate that they will not be found which may point out that they will be in a secluded or difficult to reach location. The presence of a note does not automatically mean that the target has committed suicide as some people use these notes for shock tactics to get attention or they change their minds and not follow through.

Gender is very important in determining whether suicide is a possibility. Men are three times more likely to take their own lives than women (ABS 2021). Men, 18-45, are the greatest at risk. Within the men group Aboriginal and Islander males are at a higher risk than average. Hanging is the most popular method (51%), with poisoning by drugs (15%) and poisoning by other methods such as car exhaust (16%) following. Jumping from high buildings, drowning, firearms, etc. account for the remainder. Married men are less likely to commit suicide.

Once a person has reached the decision to commit suicide, they generally want to carry it out as soon as possible for the least amount of effort. Access to the means to do so should be investigated by the SMC as this may determine how and where it may take place.

There are many recorded instances where an adult has gone missing with their children. The killing of the children prior to suicide is not uncommon.

With the increased mobility of today's young people, it is often difficult to obtain sufficient details of a missing person because they have not established a close circle of friends. Computer sites such as 'You tube', Facebook and 'Myspace' may provide details about a missing person and any intentions that they may have.

An increasing percentage of all persons who go missing do so with the intent of committing suicide. The reasons for this are beyond the scope of this document but a wide and varied. The SMC should consider whether the MP is genuinely at risk of taking their own lives and what strategy should be used. Studies have shown that there is a strong link between depression and suicide. The two strongest indicators that a depressed person may contemplate suicide are:

- a) They have left a suicide note indicating their intentions of taking their own lives.
- b) They have recently talked about taking their own lives.

The SMC needs to obtain a detailed profile of the target person. There is often something in their background that is either the cause or trigger for them to contemplate suicide. Problems to look for are:

- Relationships
- Finances
- Sexual
- Employment
- Education
- Medical
- Mental health
- Addictions

If someone who is suffering depression has indicated an intention to take their own life, and has one or more of the above triggers present, there is a high probability that the person poses a high risk of taking their own life. The risk is normally low pre-teens and increases during puberty and adolescence, reaching a peak in the mid-twenties and remaining relatively constant until old age.

Religious conviction may be an indicator of suicide intent. Strongly Christian believers are less likely to commit suicide. Those with no religious beliefs have a high tendency towards suicide. In some religions, such as Judaism, Islamic, Hindu, Shinto, suicide is a valid way to depart earth.

If there is a suicide note, the contents may provide important information regarding where and how the person intends to suicide. It may provide specific information about a favourite or known location. It may also indicate that they will not be found which may point out that they will be in a secluded or difficult to reach location. The presence of a note does not automatically mean that the target has committed suicide as some people use these notes for shock tactics to get attention or they change their minds and not follow through.

Gender is very important in determining whether suicide is a possibility. Men are three times more likely to take their own lives than women (ABS 2021). Men, 18-45, are the greatest at risk. Within the men group Aboriginal and Islander males are at a higher risk than average. Hanging is the most popular method (51%), with poisoning by drugs (15%) and poisoning by other methods such as car exhaust (16%) following. Jumping from high buildings, drowning, firearms, etc. account for the remainder. Married men are less likely to commit suicide.

Once a person has reached the decision to commit suicide, they generally want to carry it out as soon as possible for the least amount of effort. Access to the means to do so should be investigated by the SMC as this may determine how and where it may take place.

There are many recorded instances where an adult has gone missing with their children. The killing of the children prior to suicide is not uncommon.

With the increased mobility of today's young people, it is often difficult to obtain sufficient details of a missing person because they have not established a close circle of friends. Computer sites such as 'You tube', Facebook' and 'Myspace' may provide details about a missing person and any intentions that they may have.

Lost Person Behaviour Psychological Illness

Characteristics:

- a. May be evasive and run or hide
- b. Often not respond to their name
- c. Rarely travel purposely to a target
- d. Medication or lack of it may be a problem.
- e. May be frightened of authority and of being found
- f. Can be aggressive
- g. Not actually lost in the normal sense.
- h. Difficult to predict behaviour

Tendencies:

- a. Do not often penetrate forest or thick undergrowth
- b. Will seek shelter and seclusion
- c. May walk out when ready

Strategies:

- a. Check all buildings and places of shelter/seclusion
- b. Check drains, streams and tracks.
- c. Obtain profile by talking to family, friends and medical experts.
- d. Dogs may be of use.
- e. Containment a priority
- f. Re-search areas and tracks
- g. On-going search of buildings as target may return to areas already searched.

Where located statistically:

- | | |
|---------------------|-----|
| a. Road, Linear | 29% |
| b. Habitation | 19% |
| c. Building/shelter | 14% |
| d. Stream | 14% |
| e. No trace | 9% |
| f. Open ground | 9% |

% of category	25	50	75	80	95
Distance from LKP (KM)	0.55	1.23	4.05	4.7	11.73

Lost Person Behaviour Developmental Problems

Characteristics:

- a. Lack the concept of being lost
- b. Cross between young children and Alzheimer's.
- c. Generally good survivability
- d. Do not often respond to names or other signals.
- e. May also have a physical impairment.
- f. Rarely travel to a specific target but will seek shelter
- g. Will often penetrate thick forest and undergrowth
- h. Will often run away and avoid searchers.

Tendencies:

- a. Not route orientated.

Strategies:

- a. High urgency
- b. Obtain profile from family
- c. Dogs may assist
- d. Detailed ground search
- e. Check streams and drains
- f. Re searching areas is important.
- g. Check buildings etc ongoing.

Where located statistically:

- a. Building/shelter 40%
- b. Road, Linear 30%
- c. Forest 20%
- d. No trace 6%
- e. Open ground 4%

% of category	25	50	75	80	95
Distance from LKP (KM)	0.63	1.85	4.46	5.02	23.9

Lost Person Behaviour Alzheimer's/Dementia

Characteristics:

- a. Poor short-term memory but may remember things that happened many years ago, such as address while a child.
- b. Impaired ability to rationalise surroundings.
- c. Often last seen in their home or a nursing home.
- d. May have a previous history of wandering
- e. Other physical problems may exist (Limited mobility, poor sight or hearing)
- f. May be seeking a secluded location
- g. Will not attract attention or respond to calls.
- h. Possible not concept of being lost
- i. Will not often leave any clues apart from paradoxical undressing.
- j. Often succumbs to the environment (Hypothermia etc)
- k. 25% fatality rate if not located within first 24hrs
- l. Two types, walkers and non-walkers

Tendencies:

- a. Often located a short distance from a road or path.
- b. Will often attempt to travel to a place previously known to them.
- c. Will be stopped by fences, hedges etc.
- d. Will tend to walk on the path of least resistance, downhill, and not often uphill. (Be aware: more physically capable, MP's may walk uphill or in a direct line regardless of terrain).
- e. Can be found in drains or streams due to the low levels.
- f. May remove items of clothing

Strategies:

- a. High urgency
- b. Early containment is essential
- c. Use dogs or trackers
- d. Check all drains and low-lying areas.
- e. Check all fences, hedges and private yards in vicinity
- f. Thorough search of the house, nursing home, and repeat every few hours.
- g. Search heavy bush
- h. Search previous home locations.

Where located statistically:

- | | |
|--------------------------|-----|
| a. Habitation/ structure | 35% |
| b. Road | 35% |
| c. Water | 10% |
| d. Open ground | 6% |
| e. No trace | 5% |
| f. Forest | 4% |
| g. Clearing | 3% |

% of category	25	50	75	80	95
Elderly/non-walker Distance from LKP (KM)	0.19	0.75	1.42	1.5	3.9
Younger/walker Distance from LKP (KM)	0.49	1.28	2.76	3.2	14.00

Appendices

Lost Person Behaviour Hikers/Walkers

Characteristics:

- a. Often track orientated but become disoriented if they miss their track junctions or it is overgrown and not easily found.
- b. Tend to travel further than other categories.
- c. At times poorly prepared or experienced for type of walk.
- d. Will often attempt to self-help by track running or seeking a high spot.
- e. May follow paths of least resistance, such as streams and forest boundaries.
- f. May panic and be irrational
- g. May look for shelter in poor weather, at nightfall or if injured.
- h. May seek higher ground to attempt a reorientation
- i. May seek higher ground to gain mobile telephone reception

Tendencies:

- a. Stay on tracks
- b. Seek shelter
- c. Seek high ground

Strategies:

- a. Containment
- b. FAST and Reconnaissance teams to high probability areas.
- c. Track searches.
- d. Obtain profile and route details
- e. Being clue aware.
- f. Be aware of the potentially large distances the MP could have walked.

Where statistically located:

- | | |
|---------------------|-----|
| a. Road, Linear | 48% |
| b. Stream | 27% |
| c. Building/shelter | 10% |
| d. Fence | 4% |
| e. Forest edge | 3% |
| f. Forest | 3% |
| g. Open ground | 1% |
| h. Water | 1% |

% of category	25	50	75	80	95
Distance from LKP (KM)	1.15	2.56	4.95	5.76	15.15

Note: This LPB category is the only one that is NOT a circle around LKP. This distance is either side of their intended track.

Lost Person Behaviour Hunters

Characteristics:

- a. Often game focused, which tends to contribute to their being lost.
- b. Will not often acknowledge that they are lost.
- c. Following targets often leads them to deadfall areas, boulder fields, underbrush or dense forest.
- d. Will go to great lengths to self-help.
- e. Will sometimes avoid searchers for fear of embarrassment.
- f. Often rely on GPS, radios and mobile phones.
- g. Usually mobile and responsive.
- h. Tend to travel at night and will follow linear features.
- i. Will take easy routes, ridge lines, cross country.
- j. Will make shelter and fire where possible.

Tendencies:

- a. Will attempt to self help
- b. Seek shelter
- c. Seek high ground

Strategies:

- a. Containment
- b. FAST and Reconnaissance teams to high probability areas.
- c. Use of attraction techniques.
- d. Check historical finds
- e. Air searches.
- f. Be aware of the potentially large distances the MP could have walked.

Where statistically located:

- | | |
|---------------------|-----|
| a. Road | 52% |
| b. Forest | 10% |
| c. Building/shelter | 9% |
| d. Stream | 9% |
| e. Water | 8% |
| f. Ridges | 6% |
| g. Open ground | 3% |
| h. Rocks | 3% |

% of category	25%	50%	75%	95%
Distance from LKP (KM)	0.96	2.09	4.82	17.2

Lost Person Behaviour Climbers

Characteristics:

- a. Will often travel considerable distances to reach climb site.
- b. Generally well equipped but beginners may attempt difficult climbs without adequate equipment.
- c. Often overdue because of over estimation of climbing ability (39%).
- d. May be caught out in bad weather (24%)
- e. Being lost is not common (17%).
- f. Being stuck because of weather is common.
- g. Trauma is often experienced (Rocks falling on them or others).
- h. Will often be lost going to and from the climb site.
- i. Some climbers are stranded by nightfall (12%) and cannot go up or down.

Tendencies:

- a. Will attempt to self help
- b. Seek shelter
- c. Seek high ground

Strategies:

- a. Containment
- b. FAST and Reconnaissance teams to high probability areas and tracks.
- c. Use of attraction techniques.
- d. Snow/Avalanche search if necessary
- e. Thorough search of 25% zone
- f. Climbing location is the immediate area
- g. Check other climbs and routes in area.

Where statistically located:

- | | |
|----------------|-----|
| a. Scrub | 40% |
| b. Water | 27% |
| c. Rocks | 27% |
| d. Road | 20% |
| e. Ridges | 18% |
| f. Open ground | 9% |
| g. Stream | 9% |
| h. Forest | 9% |

% of category	25%	50%	75%	100%
Distance from LKP (KM) Day climber	0.0	0.3	0.8	1.8
Mountaineer	0.1	1.0	3.0	10.5

Lost Person Behaviour Prospectors

Characteristics:

- a. Often do not tell family and/or friends of exact location
- b. Often prospect alone, even if with a group
- c. Often become distracted by detection equipment, ore formations on ground
- d. Often well prepared for prospecting
- e. Not often well prepared for extended survival, limited water/food carried
- f. Not often equipped with GPS, compass, map
- g. Often rely on memory or maps kept on their person.
- h. Not always fit

Tendencies:

- a. Are not track orientated
- b. Tend to take limited notice of surroundings outside of immediate area of interest
- c. Tend to prospect out and back from a central location
- d. May travel larger distances following a possible ore seam, ground formation
- e. May lose track of time
- f. May attempt to self help
- g. May seek shade, water where possible

Strategies:

- a. Identification of central location, camp or LKP
- b. Obtain information on where ore has been located previously in area
- c. Check all abandoned/old/current mine shafts
- d. Thorough search of a small area around identified central location
- e. Confinement is a low priority
- f. Passive techniques should be attempted
- g. Aerial searching may provide clues and aid in self help

Where located statistically:

- a. Open country (Tracks, desert, lightly wooded) 32%
- b. Closed country (Thick woodland) 32%
- c. Creeks, dry water courses 18%
- d. No trace 12%
- e. Mine shafts (Abandoned/used) 6%

% of category	25	50	75	95
Distance from LKP (KM)	0.75	1.7	3.5	6.5

Lost Person Behaviour ADD, ADHD, Asperger's, Autism

Characteristics:

- a. Tend to travel alone
- b. Not track or trail orientated
- c. Have an affinity for water
- d. Have difficulty concentrating
- e. Have limited social skills
- f. Often don't recognise/understand they are lost
- g. Limited survival skills but survivability is increased due to rapid response
- h. Rarely respond to call and whistles and may hide.

Tendencies:

- a. Appear to wander aimlessly but may have a destination or plan in mind.
- b. Will often head to water (Pools, creeks, canals, drains, golf course water hazards)
- c. Will possibly be avoiding searchers
- d. Limited fear of the unknown
- e. Often unresponsive to passive search techniques
- f. May be attracted to vessels, vehicles, trains or aircraft

Strategies:

- a. Investigation of characteristics of MP is important (May think they are playing)
- b. Urgent response required
- c. Check all water hazards
- d. Establish barriers and/or confinement
- e. In an urban environment a minute systematic search is required
- f. Utilise media
- g. Passive techniques not successful

Where located statistically:

- | | |
|--|-----|
| a. Habitation (Buildings and yards) | 40% |
| b. Water/water's edge | 30% |
| c. Forest/woods/paddocks/grassed areas | 20% |
| d. Road | 10% |

% of category	25	50	75	95
Distance from LKP (KM)	0.25	0.6	1.2	6.0

Appendix E-6 Land Search Planning Tables

Land Search Planning Tables

- Select speed of Searcher:

Search member speed kph	
5kph	Consistent walking pace, undulating ground, light vegetation
4kph	Steady walking pace partly restrained by vegetation and topography
3kph	Walking pace restrained by vegetation and topography
2kph	Slow walking pace considerably restrained by vegetation and topography
1kph	Dead slow walk severely hampered by vegetation and topography

- Select search spacing (in kph):

Searcher spacing	
50m (0.05km)	Open grassland or pasture
40m (0.04km)	Open grassland interspersed with light shrubbery
30m (0.03km)	Open country with low lying scrub and light undergrowth
20m (0.02km)	Heavier scrub, medium undergrowth
15m (0.015km)	Heavy scrub, undergrowth to shoulder height
10m (0.01km)	Heavy shrub, dense undergrowth
5m (0.005km)	Ground visual between searchers
2.5m (0.002km)	Dense undergrowth, ground visual

- Then calculate Area (A), Time (T), Number of searchers (N), Search Pace (P) or Spacing (S)

$$A = T \times N \times P \times S$$

$$T = A \div (N \times P \times S)$$

$$N = A \div (T \times P \times S)$$

$$P = A \div (T \times N \times S)$$

$$S = A \div (T \times N \times P)$$

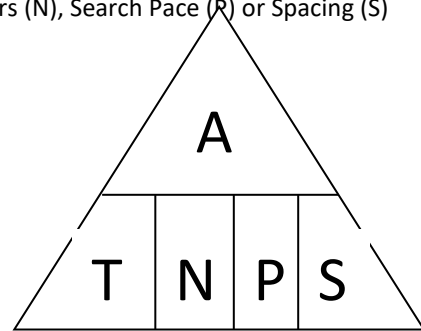

Eg: What area could I search with 20 personnel, at 5m spacing, walking at 2kph in 3 hours?

$$A = T \times N \times P \times S = 3\text{hrs} \times 20 \times 2\text{kph} \times 0.005\text{km} = 0.6\text{km}^2$$

$$T = A \div (N \times P \times S) = 0.6\text{km}^2 \div (20 \times 2\text{kph} \times 0.005\text{km}) = 3\text{hrs}$$

$$N = A \div (T \times P \times S) = 0.6\text{km}^2 \div (3\text{hrs} \times 2\text{kph} \times 0.005\text{km}) = 20 \text{ searchers}$$

$$P = A \div (T \times N \times S) = 0.6\text{km}^2 \div (3\text{hrs} \times 20 \times 0.005\text{km}) = 2\text{kph}$$

$$S = A \div (T \times N \times P) = 0.6\text{km}^2 \div (3\text{hrs} \times 20 \times 2\text{kph}) = 0.005\text{km} = 5\text{m}$$

Land Search Area Quick Reference

Eg At 1kph and 5m spacing = 0.005km²/searcher/hour

Speed	Area covered in km ² at track spacing of:							
	2.5m	5m	10m	15m	20m	30m	40m	50m
1	0.0025	0.005	0.01	0.015	0.02	0.03	0.04	0.05
2	0.005	0.01	0.02	0.03	0.04	0.06	0.08	0.1
3	0.0075	0.015	0.03	0.045	0.06	0.09	0.12	0.15
4	0.01	0.02	0.04	0.06	0.08	0.12	0.16	0.2
5	0.0125	0.025	0.05	0.075	0.1	0.15	0.2	0.25

Land Air Search Planning Table

Uncorrected Sweep width (Wu) for visual search OVER LAND. 'Wu' is in kilometres for this table (Pilots will be able to convert back to NM if necessary).

		Human					Vehicle				
Search Height (ft)		0	500	1000	1500	2000	0	500	1000	1500	2000
Visibility	2km	-	0.75	0.75	-	-	0.93	1.11	1.3	1.11	0.93
	5km	-	0.75	0.75	-	-	1.3	1.66	2.78	3.15	3.7
	10km	-	0.75	0.75	-	-	1.66	2.40	2.78	3.15	3.7
	15km	-	0.93	0.75	-	-	1.66	2.40	2.78	3.15	3.7
	20km	0.75	1.11	0.93	0.75	0.75	1.66	2.40	2.78	3.15	3.7
	25km	0.75	1.11	0.93	0.75	0.75	1.66	2.40	2.78	3.15	3.7
	30km	0.75	1.11	0.93	0.75	0.75	1.66	2.40	2.78	3.15	3.7
	35km	0.75	1.11	0.93	0.75	0.75	1.66	2.40	2.78	3.15	3.7
	40km	0.75	1.11	0.93	0.75	0.75	1.66	2.40	2.78	3.15	3.7
	55km	0.75	1.11	0.93	0.75	0.75	1.66	2.40	2.78	3.15	3.7
	75km	0.75	1.11	0.93	0.75	0.75	1.66	2.40	2.78	3.15	3.7
90km	0.75	1.11	0.93	0.75	0.75	1.66	2.40	2.78	3.15	3.7	

Vegetation Correction Factor (Ve)

Vegetation	Human	Vehicle
Less than 15% (Open areas or scattered shrub)	0.8	1.0
15% to 60% (Medium scrub or forest)	0.5	0.7
60% to 85% (Dense scrub or forest)	0.3	0.4
Over 85% (Rain forest)	0.1	0.1

Cloud cover correction factor: Shadows cast by scattered and broken clouds are a distracting influence on observers. Compensate for this by rounding down the corrected sweep width when the sky is partially obscured.

Eg. Target is a missing person, Vis = 20km, Search height is 1000ft, vegetation is 15-60%

Corrected Sweep Width(W) = $W_u \times V_e$

$W = 0.93 \times 0.5$

$W = 0.465\text{km}$ (Round down to 0.45km or 0.4km for partly obscured sky)

Most Common Applications

Land searching for:

1. Missing person open terrain(Farming country, desert areas) = SEARCH HEIGHT 500ft TRACK SPACING 500m
2. Missing vehicle in relatively open terrain = SEARCH HEIGHT 2000ft TRACK SPACING 3km

Appendix E-7 Additions to Naismith's Rule

Land Speed/Time Calculations		
Terrain	Speed	Per minute equivalent
Road	5kph	100m each 1.2 minutes
Track	4kph	100m each 1.5 minutes
Trail	3kph	100m each 2.0 minutes
Off Track	2kph	100m each 3.0 minutes
Scrub	1kph	100m each 6.0 minutes
Ascending: Add 12 minutes per 100m for overall time taken (Equivalent to 1hr every 500m ascent)		
Descending: Add 6 minutes per 100m for overall time taken (Equivalent to 1hr every 1000m descent)		
Fatigue		2 hours add 10 minutes 3 hours add 25 minutes 4 hours add 40 minutes 5 hours add 60 minutes

In the past three decades much work has been devoted to modifying Naismith's rule to meet modern conditions. One such system is to utilise Naismith's Rule to calculate a time then apply Tranter's Corrections when working out a possible search area.

Time taken to climb 300m in 800m																
Individual fitness in mins	Times taken in hours estimated using Naismith's Rule															
	2	3	4	5	6	7	8	9	10	12	14	16	18	20	22	24
15 very fit	1	1.5	2	2.25	3.5	4.5	5.5	6.8	7.8	10	13	14.5	17	19.5	22	24
20	1.25	2.25	3.25	4.5	5.5	6.5	7.75	8.8	10	13	15	17.5	20	23		
25	1.5	3	4.25	5.5	7	8.5	10	12	13	15	18					
30	2	3.5	5	6.75	8.5	10.5	12.5	15								
40	2.75	4.25	5.75	7.5	9.5	11.5										
50 unfit	3.25	4.75	6.5	8.5	Too much to be attempted											
Limit Line																

The fitness level in the first column is the time it takes to climb 300m in 800m and can be determined through series of trials.

The following corrections to Tranter's Corrections should also be made for the following conditions:

20kg load being carried	Drop one fitness level
Conditions underfoot	Drop one level or more according to conditions
Conditions overhead	Drop one level for journey at night or if wind is blowing against you

Appendix E-8 Land SAR Probability of Detection (Land)

Caveat: POD for land is a new concept within Australia. It is more common in Canada, UK and New Zealand. The theory behind this is based on the Marine POD. The theory and mathematics is scientifically sound though has yet to be tested in a legal situation within Australia.

Area of Search: Area of Search (S) is the actual area, in square kilometres, to be searched by a particular team. The desired effective sweep width is a function of detection capability. The more difficult the target to detect, the closer the searchers should be. Decreasing the sweep width increases the POD, but at the expense of reducing the area searched in a given time. There is a limit to which S may be reduced due to the limits of the search asset's navigation ability and accuracy. The optimum sweep width is one which permits the maximum expectation of target detection in the available time, or is consistent with the economic employment of search assets. Whenever possible the Area Searched (W) used should be equal to the Area of Search (S)

Coverage Factor (C): The coverage for a land search is a relationship between Area Swept and the Area of Search. The relationship is termed Coverage Factor.

$$\text{Coverage Factor (C)} = \frac{\text{Area Swept (W)}}{\text{Area of Search (S)}}$$

The relationship between Area Swept and the Area of Search determines the Probability of Detection (POD). The area swept is the actual area that was covered by the searchers (Calculated using ATNPS or on area determined at team debrief), while the area of search is the area given to that team to search. Higher coverage factors indicate that a search has been thorough and offer a higher probability of target detection; however the higher POD is not proportional to the extra search effort required. Where possible the SMC should be aiming for a coverage factor of 1, that is, the area given to the team is capable of being searched in the time frames available. There will be many occasions when terrain, time limitations, largeness of the search area, or shortage of searchers will prevent this. These situations will need an alternative approach that balances the factors of available search hours, size of area and C.

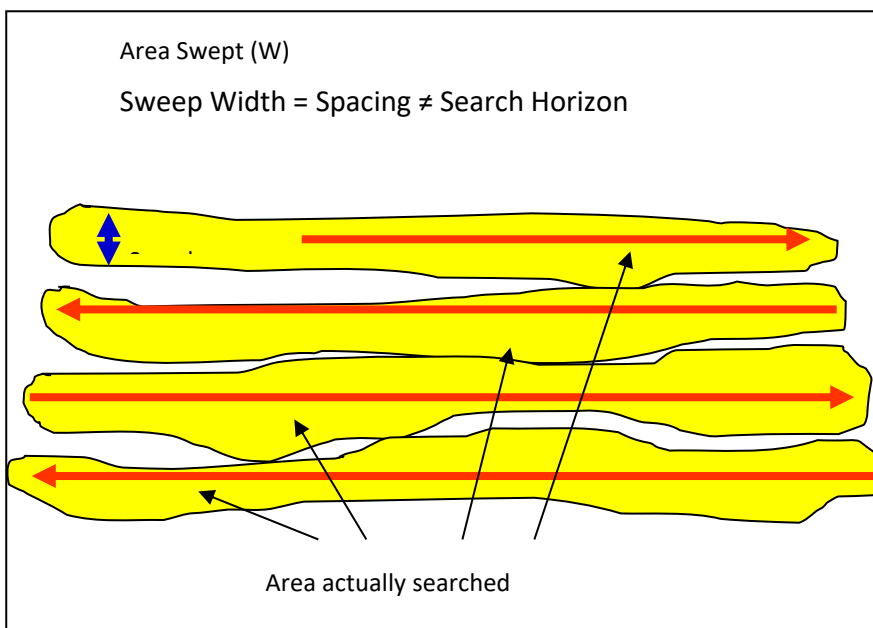

Figure E-8:1: Area Swept

Probability of Detection (POD): Probability of detection (POD) is the statistical measure of search detection performance. It is a function of:

- a) Number of searchers
- b) Size of area to be searched
- c) Speed of searchers
- d) Spacing of searchers
- e) Fatigue
- f) Responsiveness or not of the target
- g) Detectability of target
- h) Daylight or darkness
- i) Vegetation and terrain
- j) Weather

These factors ultimately equate to the ratio of the Area Swept and the Area of Search. It is also conditional, meaning that search planners assume the search target is in the search area. A definite POD exists for each scan made by an individual searcher. The probability that a discovery will be made in a single search scan is called the instantaneous POD. The instantaneous POD, repeated by successive scans as the searcher moves along the track, develops the probability pattern of a given search. The POD is not uniform over the swept area. In general, it is highest near the searcher and decreases with distance from the searcher. Although POD is based upon each searcher the end calculation will pertain to the SRA. POD is a function of the coverage factor (C), which itself is derived from the relationship of Area Swept and the Area of Search. Researching areas for second or subsequent searches will have the effect of increasing the cumulative POD. The application of this concept results in a progressive increase in the POD of a target in the most likely sector of the search area by repeatedly searching the original area within progressively larger areas, a part of each overlaying the original.

Early search efforts should not be limited in anticipation of the benefits of the expanded search technique; these will take time to accrue, and time, in the rescue of survivors, is of the essence. Neither should a particular search be prolonged unnecessarily in similar anticipation. The concept of expanded search does allow flexibility in search planning in as much as the desired quality of search, if unattainable on account of limitations in the availability of search assets, may be attained by repeated effort, while ensuring that the most likely area is rapidly and repeatedly covered.

Utilising the land POD v Coverage Table below it can be seen that, when compared with maritime SAR, there is only one search line which is to be used for all searches. A Coverage Factor (C) of 1.0 will give a POD of approximately 63%, whereas a Coverage Factor (C) of 0.5 will give a POD of approximately 40%. Some confusion may exist over this graph. It is generally assumed that if the area swept and the area of search is the same, the Coverage Factor (C) will be 1 or 100%. This is not the case as land search is in a three dimensional environment and it is not possible for any SRA to search every location within a land search area, hence the 63% POD (Searchers may be looking left instead of right, down instead of up). This is because there are always going to be gaps in where searchers search, refer to the Area Swept diagram on the previous page. The yellow areas are those searched while the white areas in between are those that were missed. In reality, a searcher has searched approximately 63% of the area assigned to them. The following example will make this clearer:

There are 2 hours to search an area of 1km². There is a team of 10 personnel who will walk at 2kph with a space of 20 metres between searchers. (20m = 0.02km). All measurements need to be in the same terms, either metres or kilometres.

$$\text{Area Swept (A)} = \text{Time (T)} \times \text{Number (N)} \times \text{Pacing (P)} \times \text{Spacing (S)}$$

$$\text{i.e. } A = \text{TNPS}$$

$$A = 2\text{hrs} \times 10 \text{ searchers} \times 2\text{kph} \times 0.02\text{km}$$

$$A = 0.8\text{km}^2$$

Coverage:

$$C = \text{Area Swept} \div \text{Area of search}$$

$$C = 0.8\text{km}^2 \div 1.0\text{km}^2$$

$$C = 0.8$$

This figure can now be used in a Land SAR POD Table as shown below. Using the 0.8 on the bottom line we arrive at a coverage figure of 56%. This is because land search is always a compromise between spacing and the ability to see objects on the ground. It is almost impossible to achieve a 100% POD for any land SAR.

A coverage factor of less than 0.5 may be unsatisfactory.

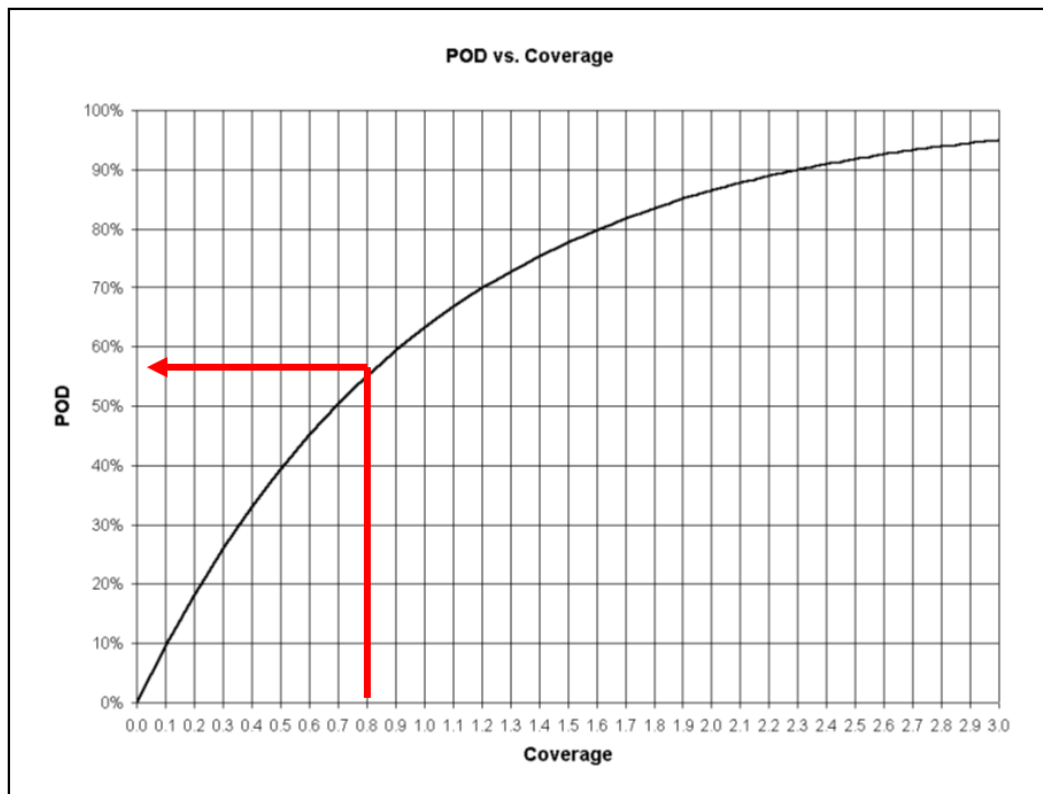

Figure E-8:2: Land SAR POD Table

Technically it is not possible to search an area greater than that assigned so how do you get a Coverage Factor (C) greater than 1? If you have a 2km² area to search and have the following: 2 hours, 10 searchers walking at 2kph and spacing of 50m.

Appendices

Using the ATNPS formula this will give a Coverage Factor (C) of 1

$$A = 2\text{hrs} \times 10 \text{ searchers} \times 2\text{kph} \times 0.05\text{km spacing} = 2\text{km}^2$$

$$C = 2\text{km}^2 \div 2\text{km}^2 = 1 = 63\%$$

If I increase the number of searchers by 5, but utilise them in the same area:

$$A = 2\text{hrs} \times 15 \text{ searchers} \times 2\text{kph} \times 0.05\text{km spacing} = 3\text{km}^2$$

$$C = 3\text{km}^2 \div 2\text{km}^2 = 1.5 = 78\%$$

Although the formula gives a larger area searched, in reality we have searched the original area to a greater extent, with the five extra searchers. We can increase either the time allowed to search an area, the number of searchers, search pacing or their distance apart to increase the C. (Twice the speed will double the area searched, or in our case, searching the same area twice, going up and back. The same will apply if the spacing is increased.)

The Land Cumulative POD Table (At end of this appendix) shows that two searches with an initial C of 0.5 (39% POD) will combine to produce a total POD of 64%, which is equivalent to conducting one search with a C of 1.0. It can also be seen that as more searches are conducted within that particular search area the POD slowly increases, as would be expected. Two searches in a particular area can be worked directly off the Land Cumulative POD table with the first search POD being entered on the left and the second across the top. For a third search the cumulative POD for the first two searches is entered into the left side of the table and the new search POD across the top. Eg. Search 1 has a POD of 40%, search 2 has a POD of 50%. A cumulative POD for these two searches is 70%. Search 3 has a POD of 40%. Using the 70% from the first two searches on the left of the table and the new POD of 40% across the top a three search cumulative POD is 82%. This process is continued for each subsequent search. From the foregoing, it is apparent that for lengthy and repeated searches when searcher numbers are limited, a coverage factor of 0.5 offers a reasonable coverage of an expanded area resulting, over time, in a good POD. Search of areas at a coverage factor less than 0.5 is not recommended. Statistically, the target is more likely to be nearer the last known position than in the extremities of the search area. Application of the expanded search concept ensures that the greatest search effort is concentrated over the most probable position of the target where the POD is highest. Clearly, the expanding search procedure is best suited to situations where the approximate position or, at least, the planned route of the target is known. The projected value of the POD may be used by a SMC in determining the area of search. Use of POD may also be conveniently made in describing the results of a search, or part of a search, to interested persons not familiar with search planning techniques. Should the target not be located within the entire search area, the SMC must decide whether to continue searching it, recalculate the probability area using alternative data, or recommend the suspension of search effort.

Cumulative POD Table (Land SAR)																				
		POD for current search																		
		%	5	10	15	20	25	30	35	40	45	50	55	60	65	70	75	80	85	90
POD for previous search	5	10	15	19	24	29	34	38	43	48	53	57	62	67	72	76	81	86	91	95
	10	15	19	24	28	33	37	42	46	51	55	60	64	69	73	78	82	87	91	96
	15	19	24	28	32	36	41	45	49	53	58	62	66	70	75	79	83	87	92	96
	20	24	28	32	36	40	44	48	52	56	60	64	68	72	76	80	84	88	92	96
	25	29	33	36	40	44	48	51	55	59	63	66	70	74	78	81	85	89	93	96
	30	34	37	41	44	48	51	55	58	62	65	69	72	76	79	83	86	90	93	97
	35	38	42	45	48	51	55	58	61	64	68	71	74	77	81	84	87	90	94	97
	40	43	46	49	52	55	58	61	64	67	70	73	76	79	82	85	88	91	94	97
	45	48	51	53	56	59	62	64	67	70	73	75	78	81	84	86	89	92	95	97
	50	53	55	58	60	63	65	68	70	73	75	78	80	83	85	88	90	93	95	98
	55	57	60	62	64	66	69	71	73	75	78	80	82	84	87	89	91	93	96	98
	60	62	64	66	68	70	72	74	76	78	80	82	84	86	88	90	92	94	96	98

65	67	69	70	72	74	76	77	79	81	83	84	86	88	90	91	93	95	97	98
70	72	73	75	76	78	79	81	82	84	85	87	88	90	91	92	94	96	97	99
75	76	78	79	80	81	83	84	85	86	88	89	90	91	92	93	95	96	98	99
80	81	82	83	84	85	86	87	88	89	90	91	92	93	94	95	96	97	98	99
85	86	87	87	88	89	90	90	91	92	93	93	94	95	96	96	97	98	98	99
90	91	91	92	92	93	93	94	94	95	95	96	96	97	97	98	98	99	99	99
95	96	96	96	96	96	97	97	97	97	98	98	98	98	99	99	99	99	99	99

Figure E-8:3: Cumulative POD for Land Search

Appendix E-9 Mattson Consensus

Mattson Consensus Worksheet							
Search areas	Area A	Area B	Area C	Area D	Area E	ROW	Subtotal Across (b)
Name 1	10	12	30	10	5	2	69
Name 2	15	21	50	2	2	0	90
Name 3	10	20	30	10	10	10	90
Name 4	5	30	40	5	10	5	95
Name 5	10	20	20	10	10	10	80
Subtotal Down (a)	50	103	170	37	37	27	424 (c)
Consensus Weight (d). (c) ÷ (a) = weight	50/424 = 0.12	103/424 = 0.24	170/424 = 0.40	37/424 = 0.087	37/424 = 0.087	27/424 = 0.06	
Percentage (e) = (d) x 100	12%	24%	40%	9%	9%	6%	100%

Figure E-8:4: Cumulative POD for Land Search

The Mattson Consensus is used when two or more search areas have an equal chance of being the area of highest probability. The search areas are identified across the top of the form (Areas A, B, C etc.) as it the Rest of the World (ROW) as it may be the case that the MP is outside the identified search areas. The names of the senior or more expert members of the SAR Team are listed on the left side (Name 1, Name 2 etc.), remembering that there should be at least five members.

Each member then independently gives a weighting score to each search area and the ROW. Generally the higher number weighting, the greater belief by the member that the target will be in that search area. There is no need for the weightings to add up to one hundred as this can cause skewing to ensure a fit.

The columns and rows are totalled and recorded in the appropriate places. The Consensus Weight is the total in each column at (a) divided by the total at (c). The Consensus Weight (d) is then multiplied by 100 to obtain the search area percentage (e). The search area with the highest percentage is considered, by consensus, to be the area of highest probability and would be searched first, followed by search area 2 and so on.

Appendix E-10 Land Search Organisation Chart Example

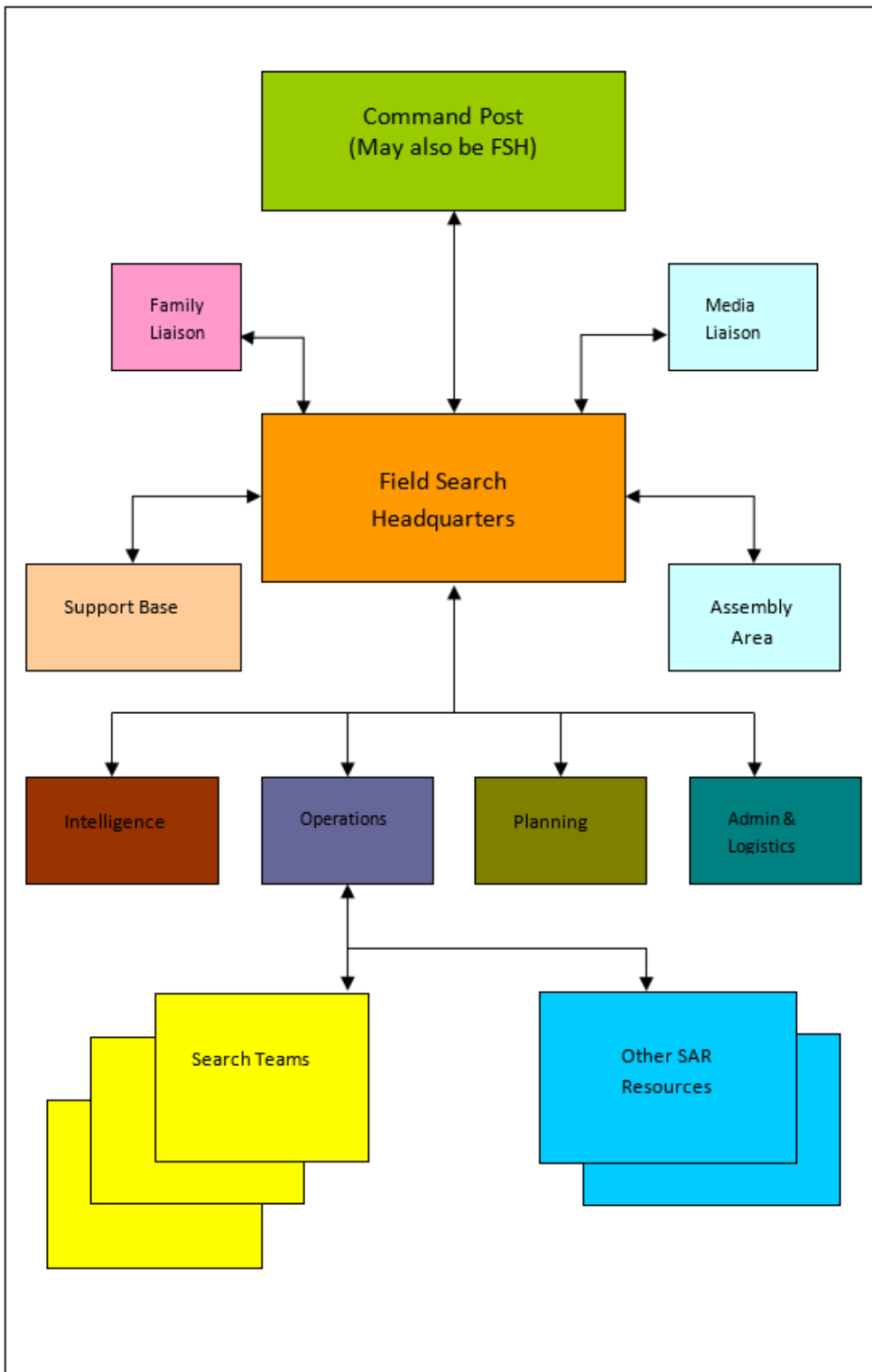

Figure E-10:1: Land Search Organisation Chart

Appendix E-11 Field Search Headquarters Layout Example

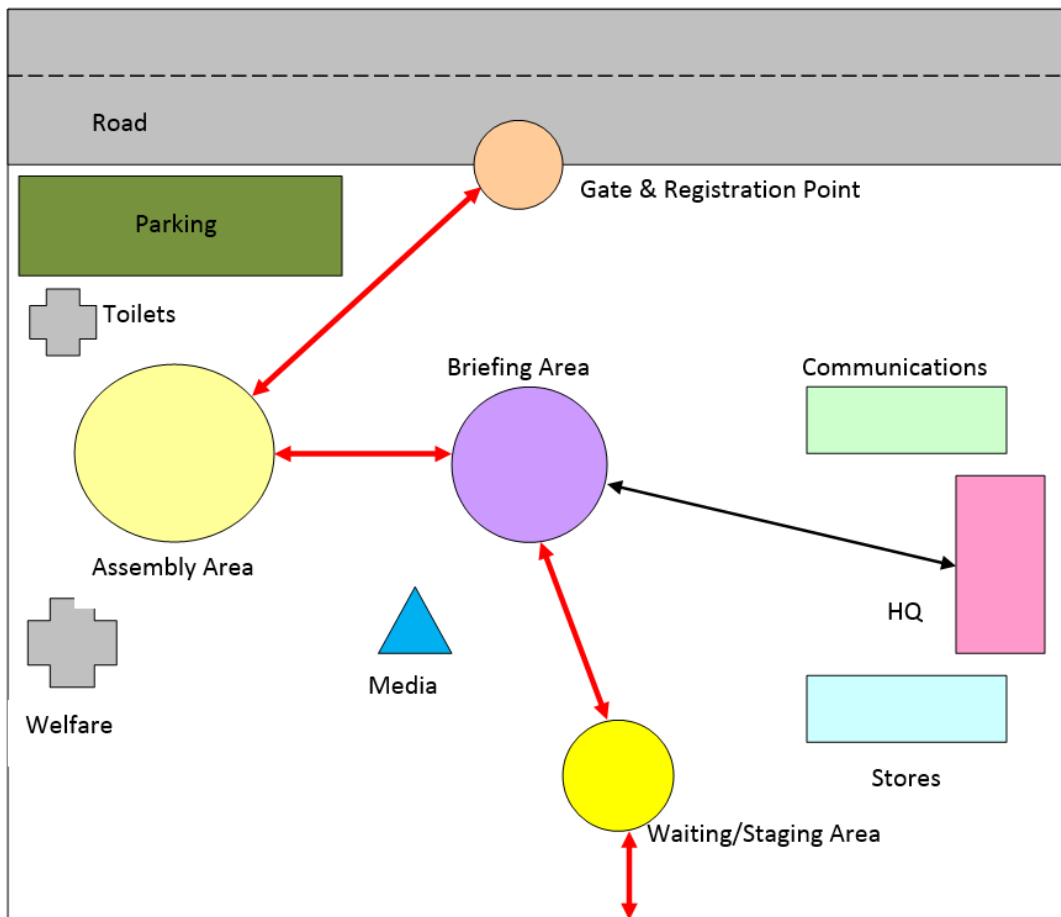

Figure E-11:1: Headquarters Layout

Appendix E-12 Search Communications Network Example

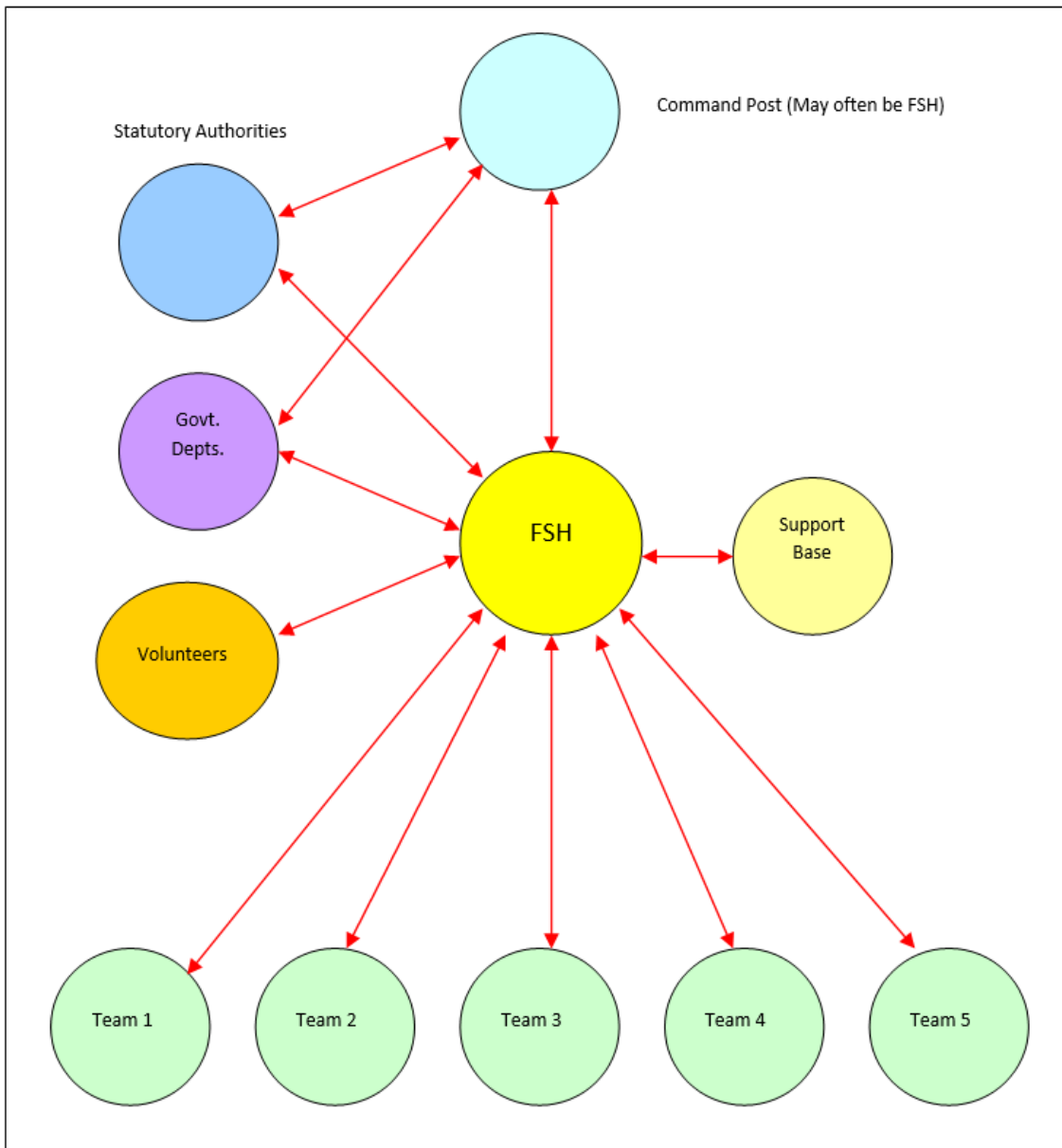

Figure E-12:1 Search Communications Network

Appendix E-13 Clue Recognition

A clue is a fact, an object, information or some type of evidence that helps to solve a mystery or problem. The purpose of seeking clues (gathering all the facts and information) is to assist in the reasoning of a problem and its ultimate solution. In SAR this assists in the ongoing development and assessment of the SAR Plan.

General Principles:

The following principles apply:

- a) Clue seeking is an ongoing process that starts with the planning, continues throughout a mission until the debrief concludes.
- b) Clue seeking is a skill and must be practiced to develop a sense of what is the minimum information to work with.
- c) Avoid forming opinions and then gathering information to support that opinion.
- d) Don't immediately form an opinion about the value of a clue.
- e) Gather information from everyone, as no one person can adequately gather all the facts.
- f) Assemble a complete profile of the missing target and the situation, and let it offer direction.

Tracking Skills

The ability for searchers to recognise signs that are not obvious clues within their search area can dramatically reduce the duration of the search. These signs may be quite obvious to some searchers but may go unseen by others. Developing skills in reading signs of activity within the landscape can greatly benefit the searcher and enhance their observation skills.

Trail signs

Once the size and shape of footprints is determined, another factor that can aid your search is terrain. Look at the ground. If no footprints are apparent, look for freshly overturned stones (darker on top than the others, maybe even moist looking).

Look for broken twigs and tree branches. They will usually break forward as a person pushes through unless deliberately snapped back to lay a false trail. Fresh breaks will show up as unweathered timber, differently coloured to the rest of the tree. The underside of the leaves will be duller or more brightly coloured as well, depending on the species.

Through thick bush a lighter area can often be apparent when scrub is pushed aside, much like long grass that is flattened in the direction of travel.

When footprints are found, use the weather that has occurred since the person went missing to estimate the time since the print was left. The amount of dryness of the print can determine an approximate time the person passed that way. Other factors that should be considered are described below:

- a) If the weather was previously damp and windy, a predominantly dry print will indicate it has been in the open to the wind longer and has had time to dry out.
- b) If wetter weather had occurred but no real rain has fallen recently, the same print may have been there for a lesser period. The heel will be the last area to dry. If the heel depression is dry, the person travelled that area a longer time ago than if the print is partially damp.
- c) If heavy rain has fallen, most prints will appear to wash back into the soil and be little more than a depression. Newer laid prints will be more defined.
- d) If it is currently drizzling/raining, fresh footprints may disturb the ground surface layer and produce a dry under surface.

Scuff marks on the ground, which also kicks up rocks, scuff marks on rocks where someone has climbed, broken pieces of rotted wood are all indicators of someone, or something, having travelled that way. A lost person may sit down and rest regularly, so look for heel and seat marks where they may have sat down. Think what you would do in their position and identify likely locations for rest.

Flattened ground beneath trees or amongst the undergrowth can indicate a sleeping place, either of the missing person or fauna. A check for animal cast may indicate occupation by animals. A thorough search of the area might show footprints where a person has used an animal lair. Personal items or human faeces may also be detected in these areas.

Keep an eye out for signals that have been made by the missing person. These include rock piles (sometimes a message may have been left within the layers of rocks), arrows or other marks left on the ground to indicate their direction of travel, flashes from mirrors, or items of clothing.

When tracking, work as a pair if possible. Work to either side of the track rather than directly on top of the person's track. With this method if you lose the trail you can backtrack and pick it up again and resume. If you have trampled all over it, you will have destroyed the clues.

When finding signs treat them the same as when finding search clues. Preserve them for analysis and report them.

Like all other search aspects, tracking takes much practice to develop the skill. The eye needs to be thoroughly trained, and then is used in conjunction with a knowledge of the bush.

Sight

- a) Smoke from campfires (day)
- b) Light from campfires (night)
- c) Light from torches (night)
- d) Footprints
- e) Clothing
- f) Pieces of foam sleeping mat
- g) Trail register
- h) Disturbed foliage
- i) Witnesses
- j) Discardables such as lolly wrappers, drink or food cans, cigarette butts etc.

Appendix E-14 SAR Tasking Sheet Example

SAR TASKING SHEET					
Incident No.		Task No.		How Tasked	
Date Task Issued		Time Task Issued		Call Sign	
Search Location				Radio Ch	
GPS Issued	Y/N	GPS No.		Radio No.	
Role	Name	DOB	Organisation	Phone	
Team Leader					
Search Category		Search Pattern			
SEARCH BRIEF - Map attached Y/N					
Time Out		Search Start		Search Finish	
Time In		T/L - Understood & Signed			
RESULTS					
Signed - T/L		Date & Time			
SARO/FSC COMMENTS - PFC USE					
Signed - SARO/FSC		Date & Time		Finalised	Y/N

Appendix E-15 Search for Skeletal Remains

The search for human remains from crime involves a number of techniques depending on the stage of decomposition of the target. Searches may be for the following target types:

- a) Grave sites, deep or shallow: Searchers are looking for disturbances in the landscape, vegetation changes, dips or hollows, ground discolouration and cracking. It is near impossible to dig a grave and return the scene to its original condition. An aerial search may uncover potential sites of ground and/or vegetation disturbance. Historically, once a victim is buried they are generally undisturbed until located by a search team, although there is evidence that shallow graves have been disturbed by wild and/or domestic animals.
- b) Disposal locations: Bodies may be quickly disposed of by criminals using what is readily available. (Covered with sticks and branches, leaf litter, rolled in carpet or other items, pushed into hollow items such as pipes and logs). There may be signs of darkened earth or dead vegetation caused by volatile fatty acids leeching from the body.
- c) Initial crime scene locations: The initial crime scene will provide forensic evidence and may be identified by signs of a struggle, broken branches, trampled grasses, ground disturbance, clothing, blood stains and/or other visible signs of a crime. This may not necessarily be the location of the victim.
- d) Skeletal remains and bone dispersion: Searches conducted after lengthy periods of disappearance may be looking for skeletal remains. The search for skeletal remains is dependent on a number of factors:
 - i) Length of time since initial incident: Skeletisation periods can vary from 2-3 years for persons buried in deep graves, 6-12 months for those in shallow graves and much shorter periods for those left on the surface or loosely covered. Cold weather will also slow the process of decomposition down but warm, moist weather can have the opposite effect. Wildlife distribution in the area, insects, dogs, pigs, cats, birds and other carnivores will contribute to decomposition.
 - ii) Method of disposal: Burial inhibits decomposition due to a number of factors, including limited oxygen, limited exposure to flies and animals and generally cooler temperatures.
 - iii) Animal predation in area: Animals will hasten the decomposition of flesh, leaving only the skeletal remains. Evidence shows that bone dispersion often results from animal activity. There are some generalisations for bone dispersal:
 - During the initial stages of decomposition the tendons and ligaments tend to hold a body together. This limits animal activity to removing flesh and softer body parts.
 - The body disarticulates from the outside in, with the limbs being the first to separate, allowing them to be moved by predatory animals. The skull will also separate from the vertebra and the neck vertebra from each other.
 - The limbs may be taken as a whole by predators, to be further disarticulated at other locations.
 - The skull is one of the last items to be moved due to its size and the difficulty in grasping it with teeth.
 - Bone dispersal is generally in an oval shape, with the body core being at the higher elevation focus of the oval. The limbs and other bones are mostly located in a downhill direction.
 - The oval shape is dependent on the terrain, with animals skirting rocky outcrops, thicker vegetation and waterways. The bone dispersion will generally follow animal tracks.
 - As limbs disarticulate the dispersal pattern will go from the larger bones, femur and humerus, to the medium bones of tibia, fibula, radius and ulna to the individual hand and foot bones. The smaller bones are often difficult to recognise as bones so it is recommended that a forensic osteologist be available on scene to assist with identification.

Appendices

- The main section of the body will eventually collapse on itself with some of the smaller bones, such as ribs, being moved by animals.
- The length of the dispersal oval can be between 10 and 135m depending on the local animal population. It is recommended that the latter be considered during the initial stages of the search.
- Bones can be discoloured by the environment and are often not the bleached white colour expected by searchers. They can take on the hues of the local environment due to the leeching effect of rain and the natural tannins found in plant life. The search briefing should be very clear on this point (Bone details are contained at end of this appendix).
- The age of the victim will also impact on what bones remain to be found. The bones of children and teenagers will not have fully ossified or calcified leaving only misshapen slivers or portions of bone to be discovered.
- Any objects suspected of being a bone should be examined *insitu*, as the location of each bone can provide an indication of what position the victim was originally placed.



Figure E-15:1: Bone scattering

Two search methods are recommended for skeletal searching:

- Single direction contact search. All search members are lined up shoulder to shoulder and proceed at a set pace through the search area. They should be armed with a hooked pole to move vegetation and other ground debris. Each member is responsible for their own search path. The usual rules on locating an object will apply. When a bone is located the searchers will commence a hands and knees search of the area at least 10m around the located bone.
- Search teams start at opposite ends of the search area, shoulder to shoulder and walk towards each other. The teams pass and continue on to the end of the search area. While this is more labour intensive it does allow the area to be search twice, from different directions at once, increasing to probability of detection to beyond what would be possible from two separate searches.

The pre-search briefing must be comprehensive with respect to potential search objects, bone shape, colour and size, to ensure a thorough search is undertaken. Good investigative information is necessary to reduce the potential search area to a minimum as these types of searches are labour intensive, physically tiring and mentally straining.

Bone characteristics.

Exposure on ground surface causes a number of effects:

- Bone collagen protein content is degraded by UV light and water (rain) exposure
- Bone mineral content is degraded by water exposure
- Overall, the loss of collagen is greater than the loss of bone mineral.
- The key phenomenon with ground surface exposure is transpiration.
 - Bone acts as a wick, drawing moisture from the soil and evaporating that moisture from the uppermost surface of the bone.
 - The result is the deposition of minerals from the soil pore water inside the bone cavities and the formation of surface crusts of evaporate minerals on the uppermost surface of the bone.
- Bones can be heavily degraded in as little as 2-15 years.

Surface exposed bones are typically white or light grey in colour, their surface is cracked or has a “wood-grain” appearance and is rough to the touch like sandpaper. Surface exposed bones often get snagged on clothing due to their rough texture.



Bone exposed on ground surface showing mineral crust formed on the uppermost surface of the bone due to transpiration



Bone exposed on ground surface showing brittle cracking due to loss of collagen



A series of 6 pictures of animal bones exposed on ground surface demonstrating cracking of the bone



cortex and "wood grain" appearance



Plant growth on bones

Plant root growth on bones causes shallow, etched depressions.



Plant roots may also obscure the shape of bones, making them difficult to detect.
Buried up to 20 yrs.





Botanical evidence used in a Spanish case to demonstrate time since death.

Experiments had demonstrated that skeletonisation in Spain takes 3 yrs. Plant growth on bones would occur after skeletonisation.

- a) Plant growth consistent with person missing for 6 yrs. Rib case encased in shrub root growth consistent with >3 yrs growth.
- b) Plant growth consistent with person missing for 6 yrs. Bryophyte growth on exposed tibia. Bryophytes only grow on bone when organic matter is absent (i.e. after skeletonisation). Skeletonisation takes up to 3 yrs in Spain. Bryophyte annual segments on its stems indicates 3 yrs of growth.



Fungal growth on bones

Fungal attack indicates that the bone has been in an oxygenated environment. Fungi are stunted or do not grow in low oxygen/sealed environments.



Irregular white or dark grey patches of fungal growth on surface of human hip bone.

Predator damage to bones

Bone that has passed through a carnivore's digestive system. The bone cortex can be eroded to reveal the spongy bone underneath. There may be hair sticking to the bones from the rest of the carnivore's meal.



Appendix E-16 Peer Review Form Example

This is a Peer Review of a search and rescue operation under Volume 2 Chapter 6 of the National Search and Rescue Manual. This process is aimed at identifying issues within the SAR system and providing recommendations to address any such findings.

Reviewer	
Date of review	
Missing person/s	
Incident location	
Date of incident	
SAR Coordinator/s	
Reference number	
Review Sections	Outcomes (Suggested lines of enquiry)
Situation	<ul style="list-style-type: none"> a. A brief summary of the events leading to the incident. b. Summary of targets (description, age, experience, clothing, equipment carried, medical history, mental issues, disabilities). c. Summary of location, topography, vegetation, day light hours, weather, hazards d. Identification of SAR Coordinators and experience
The National SAR Arrangements	<ul style="list-style-type: none"> a. Does this incident fall into one of the categories identified in Appendix A-2? b. Which SAR authority was best placed to initiate a response? c. Which SAR authority was responsible for this incident?
Assessment of the survivability of the incident	<ul style="list-style-type: none"> a. Time elapsed since the incident; b. Environmental conditions; c. Age, experience and physical condition of (potential) survivors; d. Survival equipment available; e. Studies or information relating to survival in similar circumstances; f. Survivability of the incident g. Were survivors able to walk/drift away from incident site? h. Was there a possibility of third party involvement
Assessment of the Last Known Position (LKP) or Splash Point (SP)	<ul style="list-style-type: none"> a. Calculations of LKP/SP utilising information available at the time. b. Correct application of current and leeway/ or Lost Person Behaviour c. Review the initial information available and any subsequent intelligence.
Examination of the search plan	<ul style="list-style-type: none"> a. Were proper assumptions were made on the information obtained b. Was a Search Urgency (SU) Form was completed c. Was the appropriate priority given to the urgency d. Were tasking sheets used, and signed upon return e. Were assigned areas were searched; f. Were resources activated and briefed in accordance with information g. Is a copy of the briefing/s available h. Was compensation made for search degradation caused by weather, navigation, mechanical or other difficulties
Assessment of the Time Frame for Survival (TFFS) and	<ul style="list-style-type: none"> a. Was an initial TFFS calculated and updated with medical advice b. Were POD calculations made c. Was the POD of a sufficiently high value to provide the best chance of location of the target/s

Probability of Detection (POD)	d. Were there factors that impacted on the POD
Assessment of the rescue plan	<ul style="list-style-type: none"> a. Was best use was made of available resources; b. Were contingency plans were sufficient to cater with unexpected developments; c. Was coordination with other agencies was effective in ensuring best treatment of survivors. d. The probability of detection was as high as desired
Assessment of intelligence, information, clues and leads	<ul style="list-style-type: none"> a. Were all available sources of information used? b. Was a review done of the information obtained c. Was the intelligence collated and evaluated? d. Was the intelligence disseminated as necessary? e. Was all intelligence utilised and appropriate weight given to it? f. Were items of information missed or overlooked? g. Was a SAR Log kept and available h. Were tasking sheets used, returned and filed i. Were data entry systems completed j. Was a termination Form completed and available k. What other strategies were used to locate target (Banks, ATO, Centrelink, Tolls, Telephone etc.)
Conclusion	<ul style="list-style-type: none"> a. Search location b. Urgency c. Sufficient and experienced coordinators d. SMC advised e. Value of search f. TFFS and POD g. Search reasoning h. Identified deficiencies in SAR (staffing, training, experience, support, POD)
Recommendations	<ul style="list-style-type: none"> a. Incident issues b. System issues or amendments c. Policy issues d. Support issues

Name:

Title:

Division/Branch/Unit/Police Station:

Distribution:

Original goes back to requesting Unit

Copy direct to State SAR Coordinator/Manager for information

Attachments

List attachments if applicable

Appendices

NATIONAL SEARCH AND RESCUE MANUAL

2023 EDITION Version 1 – February 2023

Appendix E-17 Body Flotation Information

While as accurate as possible the data contained below is based on historical incidents throughout Australia. There has been no systematic study of human body flotation after immersion in water.

Humans have large numbers of bacteria within the body cavities such as the gut and chest. These bacteria don't immediately die when a body does, but continue to metabolise and produce gas. It is this accumulation of body gasses that can raise a deceased body to the surface.

The actions of the surface, waves, and movement, combined with bird and animal activities quickly causes the built up gas to dissipate into the atmosphere. Without this buoyancy a body will then sink back down, more than likely to never re-emerge.

Issues that will affect floatation times:

- a) For every 10m of depth the pressure increases by one (1) atmosphere. This means that for depths of 30-40m or more the increased pressure and lower temperatures with generally retard any floatation of a body.
- b) Temperatures of below 5°C may not allow sufficient gas build up for a body to float. In these instances it may take until the water warms for any floatation to occur.
- c) Food ingestion is a factor that should be considered. A last meal high in carbohydrates will facilitate gas production, whereas a meal high in proteins will produce gas at a slower rate.
- d) Water temperature is an important factor for consideration. The below graph represents likely floatation times based on water temperature. This graph is based on reported floatation times for deceased bodies in inland waterways, rivers and dams. There is considerable leeway involved and is only to be used as a guide.
- e) Some medications and all alcohol will assist in gas production.
- f) Body composition is an important factor, a large obese person has more opportunity to float than a lighter muscled person. Fat or adipose is lighter than muscle mass.
- g) Children, although lighter, also have proportionally less gut. This can have the effect of slowing their floatation, and contrary to this, their higher proportion of body fat can aid in floatation.
- h) Clothing will impact the ability to float. It has been found that fishing waders and the like can inhibit floatation, whereas heavy clothing can require a significantly larger amount of gas generation for floatation. Layered clothing has been found to aid floatation in the short term, possibly through the retention of air between the layers, while in the long term it becomes an extra weight to be overcome. Light clothing and swimmers will generally have no effect.
- i) Any significant injuries to the body have been found to slow floatation. Open wounds, particularly in the chest and abdomen area can allow body gasses to escape, limiting floatation. The gasses produced by the body, hydrogen, hydrogen sulphide, carbon dioxide and methane, are all water soluble, meaning that they will dissolve if water is able to enter the body. Dissolved gasses have no lifting power. These gasses are also compressible, meaning that as depth increases their lifting power decreases.
- j) Because humans are not hydrodynamic in shape it takes very little in the way of snags to trap a body. The composition of the bottom in shallower areas can have an effect on floatation, things such as flood debris, rocks, car bodies etc. Mud and silt can have a strong vacuum suction effect on a body.
- k) People who are already deceased when they enter the water may not immediately sink. Without active respiration water entry into the lungs and gut may not immediately occur.
- l) Floatation of suicidal drowning victims can be problematic. Most of these people are weighted down by either an object such as a large concrete brick or layered clothing. Floatation does happen on occasion but it is often more likely that they are located by a diver.

- m) Almost all bodies will surface face down, the arms and legs hanging down will cause this. Bodies thrown into the water during the early stages of rigor mortis may float face up, but this is rare.

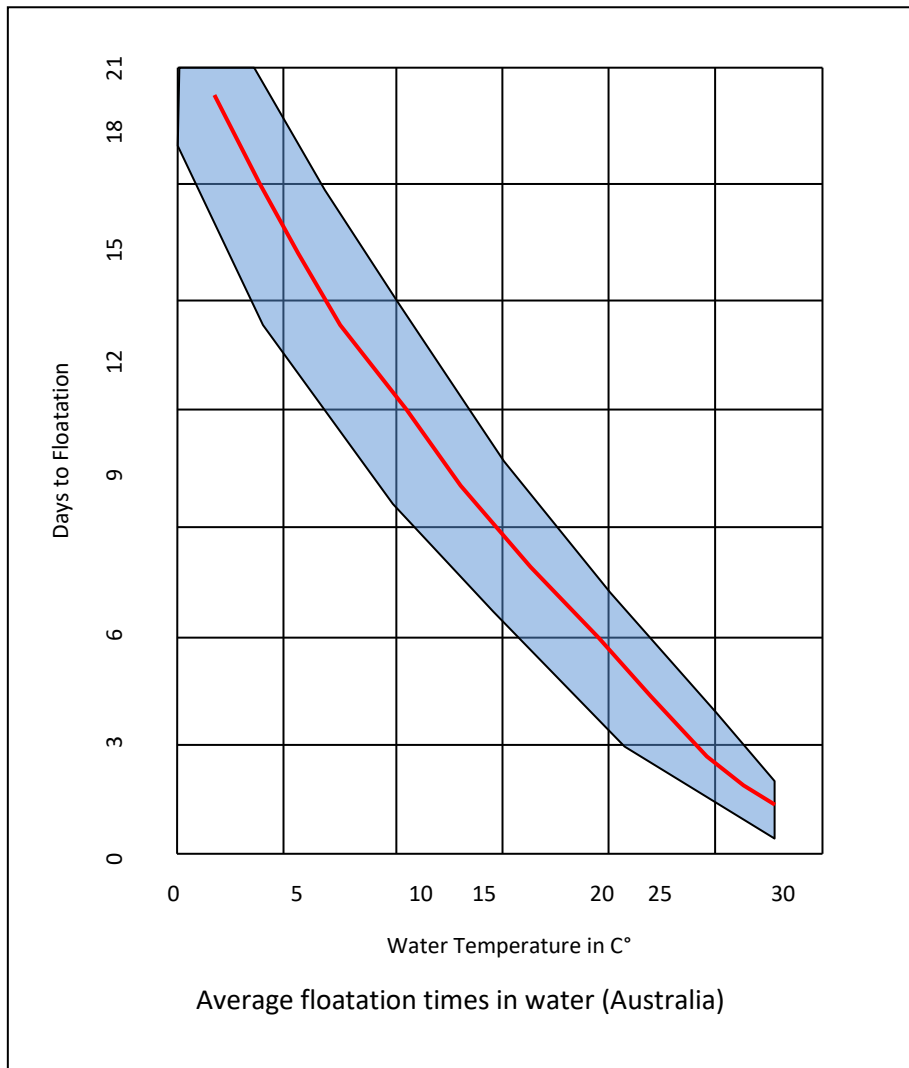

Figure E-16:1 Average floatation times in water (Australia)

Appendix F - Aircraft Electronic Night Search Guidance

Term	Definition
EO/IR, or Electro-Optic/Infrared systems	Electronic imaging systems which include both visible and infrared sensors that can be used day and night and in low light conditions with the ability to view objects at long distance.
NVD, or night vision device	Night vision enhancement equipment fitted to, or mounted in or on, an aircraft, vessel or vehicle, or worn by a person, that can: <ol style="list-style-type: none"> 1. detect and amplify light in both the visual and near infrared bands of the electromagnetic spectrum; or 2. provide an artificial image representing topographical displays.
NVIS, or night vision imaging system	A self-contained binocular night vision enhancement device, usually including goggles, that: <ol style="list-style-type: none"> 1. is helmet mounted or otherwise worn by a person; and 2. can detect and amplify light in both the visual and near infrared bands of the electromagnetic spectrum. <p>NVIS is a term used to incorporate all aspects associated with night vision, including NVD.</p>

General Considerations

1. This information provides general guidance for search planners when considering night searches by aircraft using Electro-Optic/Infrared (EO/IR) equipment and/or Night Vision Imaging Systems (NVIS).

Note 1 - day searches using visual observation plus EO may be beneficial, but this guidance focuses on night search only.

Note 2 – NVIS is used in this guidance as a collective term incorporating all aspects associated with night vision such as Night Vision Devices (NVDs) and Night Vision Goggles (NVGs).

2. It is preferable, safer, and normally more effective to search in daylight. Of course, the timing of distress situations is not always optimal for a daylight search. Where suitably capable night search aircraft with aircrew trained and competent in safe night search operations are available, SMCs may consider a night search is necessary where the urgency of the situation may be critical to saving lives.
3. Factors generally common to selection of aircraft and the ability for pilots to safely accept any search task apply such as regulatory requirements, risk factors, aircraft performance and capability, equipment fitted, aircrew training and experience, weather, nature of search area (topography, vegetation, distance offshore, availability of forced landing areas, obstacles, and powerlines, etc), fuel endurance available, transit times, available time on scene, fatigue, etc.
4. Search planners and coordinators should have a good understanding of the capability and limitations of EO/IR and NVIS searching to be able to discuss and brief an effective search plan with the aircrew to establish reasonable expectations of possible outcomes and best use of the asset. Given the range of variables for these types of searches, search planners should be guided by the aircrew's expertise and plan the search accordingly with safety of the operation the priority.

Aircraft and equipment factors

5. Aircraft type and the type of EO/IR and NVIS equipment available on board provide different search options. Aircrew training and experience play a central role in night search effectiveness.
6. Ideally the use of a combination of EO/IR and NVIS is the most effective. NVIS can provide a wide viewing area with any sightings being able to be examined in more detail using IR which has a narrower field of view and greater acuity. EO/IR cameras with the ability to zoom in on sightings provides advantages over EO/IR systems without this capability. Aircraft lighting, both internal and external, needs to be compatible with NVIS.
7. It is possible that an object can be visible in the NVIS but not be visible in the EO/IR, or vice versa depending on the object's characteristics. This may present challenges where search aircraft equipped with only one of these two types of electronic night search capability needs to transfer sighting details to another search aircraft with the other means of detection for investigation.
8. Advanced systems integrated with navigation systems, moving map displays and recording capabilities provide additional benefits to assist operators to provide greater search integrity, efficiency, and effectiveness. For search aircraft suitably fitted, the ability for the RCC to send search patterns and search areas via data files (e.g., KML files) to be uploaded to aircraft mission management systems, GNSS units or aircrew portable electronic devices (if equipped) can provide efficiencies by reducing the need for complex conversations, relay of information and human error. Such aircraft if also fitted with a GNSS flight tracking system may also be able to provide the RCC with a debrief of the actual search tracks flown.
9. Visual and IR lasers are visible using NVIS. SAR coordinators should note that some aircraft operators may have visual or IR laser capability which may be used for the purpose of guiding other aircraft and surface SAR units to a distress location. IR lasers can also be used by crew members on the same aircraft operating with different sensors to help each other acquire a sighting, for example, the crew member operating the EO/IR is having difficulty acquiring a sighting detected on NVIS by another crew member. Depending on the laser type there may be hazards associated with their use. SAR units who intend to use lasers should be appropriately authorised and trained in their use. Other assets involved in a search operation, both aircraft and surface units, should be informed when lasers are being used by search assets so they can take their own precautions with respect to laser safety and prevent confusion as to the reason for the laser.
10. Aircraft fitted with an external public address or loudhailer system may assist with providing verbal directions to a person on the surface and may give comfort to a missing person not yet located that they are being looked for.
11. Safety and capability can be enhanced for aircraft fitted with a terrain warning system, weather, or ground mapping radar and, for helicopters, auto-hover.
12. Some Light Emitting Diode (LED) lighting systems, clearly visible to the naked eye, fall outside the combined visible and near-infrared spectrum of NVIS and therefore will not be visible to aircrew using NVIS. This may present a hazard where LED lighting is used for surface obstacles. Emergency or other equipment fitted with LED lighting used by survivors may also impact detectability using NVIS.
13. Poor visibility due to contaminants in the air such as dust or smoke may compromise EO/IR and NVIS effectiveness. In maritime areas, strong winds can blow salt spray across camera lenses and windows obscuring the electronic image or view through windows, potentially leading to missed detection. Rain in the area can help clear this residue away.

Appendices

-
14. In maritime areas, detectability of unlit targets on the sea surface using NVIS will be degraded, particularly in calm conditions because of the low albedo (reflective properties) and contrast.

Survivor factors

15. Search success can be limited where people being searched for are not actively trying to be located or are not capable of actively aiding search crews, for example due to exposure or injury, or if they are hiding.
16. Ideally persons in distress will have a light source which can be easily seen by NVIS equipped crews, such as a torch, light from a mobile phone or signal fire. Reflective material may also assist. It is also possible that laser pointers may be used by persons in distress.
17. A person in the water without a light or reflective surface in broad scale searches where a specific splash point is not known is very difficult to locate at night. A known splash point with a short time frame between the splash point time and arrival of the search aircraft will increase the probability of locating the target.
18. To assist survivor awareness of the presence of the search aircraft and to elicit a survivor response signal, when the aircraft first arrives in the search area, if possible, the aircraft should be made as conspicuous as it can be by flying through the search area or orbiting at lowest safe altitude with as many external lights visible before commencing the search pattern.
19. A person in distress may see or hear the search aircraft and respond by activating a light or flare. Crews should be alert that it is possible the person in distress may not have had the opportunity to activate their light signal by the time their aircraft passes and where possible adjust their search technique accordingly, for example, by flying both directions along the same search leg or, if capable and practicable, directing their detection equipment to search both forward and behind the aircraft.
20. Survivor morale can be lifted when a search aircraft is sighted or heard during the night, even if the search aircraft does not find the survivor.

Search planning factors

21. The timeliness and accuracy of intelligence information for search area determination has a bearing on search effectiveness.
22. Search coordinators should also consider that a NVIS capable aircraft may not necessarily be capable of conducting a NVIS search. This is because:
 - a. NVIS may be used by pilots and aircrew solely for the purposes of safe air navigation and terrain avoidance functions in compliance with aviation regulations and may not have any capacity to conduct dedicated NVIS searching, whereas
 - b. other aircrew not directly involved in air navigation and terrain avoidance functions may use NVIS solely for the purposes of searching and observation.
23. Search planning should also take into account that search crews, when using EO/IR and NVIS equipment, will need periodic breaks to manage operator fatigue and provide an opportunity to view the search area with unaided electronic vision which may pick up lights that both EO/IR and NVIS cannot.
24. It is important to note that aircraft EO/IR equipment can normally only search one side of a search leg at a time, or only a forward or rear splay area at any time. Using NVIS to detect possible search targets, then using the EO/IR to investigate those sightings is generally the most effective search technique especially for small targets.

-
25. The target type will influence the type of night search to be conducted. Considerations include whether the primary target is to be a person, aircraft, vessel, or other object, its size, and its potential to provide a light source or light signal, and the amount of heat it may produce. The potential condition of the target should also be considered such as whether a survivor is likely to be capable of signalling or moving, a distressed aircraft has been damaged, or a vessel has capsized or is semi-submerged.
 26. Night searches may be more effective in areas with reduced numbers of people to avoid false sightings. Wildlife and livestock can be a distraction.
 27. Environmental conditions to consider include:
 - a. **Weather conditions** - both for search effectiveness and compliance with flight operations regulations, such as NVIS minima, ability to maintain visual meteorological conditions (VMC), risk of inadvertently entering instrument meteorological conditions (IMC), availability of optimal search altitude due to amount of cloud cover, precipitation, visibility, the action of wind over terrain and impacts of turbulence, freezing level, surface and air temperature, humidity, fog or mist, thunderstorms and sea conditions.
 - b. **Ambient light** - amount of moonlight and moon phase, position and elevation, effect of twilight and other ambient light sources. Nights with good ambient light enables more effective searching with NVIS.
 - c. **Thermal crossover** - the natural phenomenon that normally occurs twice daily when temperature conditions result in a loss of contrast between two adjacent objects on IR imagery which may have an adverse effect on IR detection.
 - d. **Bushfire activity** - EO/IR detection capability will be affected by the heat from the fire(s). NVIS detection capability will be affected by the light from the fire(s) which can cause blooming (distortion or blotting out of the image) and smoke can reduce visibility.
 - e. **Thunderstorms** – search aircraft should avoid thunderstorms by a safe distance to avoid the hazardous effects of severe turbulence, lightning, icing, etc. Distances from thunderstorms may be difficult to estimate visually when using NVIS and the fitment of airborne weather radar or other electronic detection devices to the aircraft will assist. The NVIS image may be adversely affected by lightning flashes.
 - f. **For searches over land** - the topography including type of terrain, type and degree of vegetation, ground cover such as snow, and shadows from overhanging rocks and cliffs can impact search effectiveness. Different terrain can have positive and negative impacts on night searches. For EO/IR, a hot night may cause image wash out and a lack of obvious contrast between hot and cold and cause other structures and material to maintain heat for a longer period. Rocky terrain can be difficult to search by EO/IR where objects have the ability to retain heat during the day and provide ‘false positives’ during a night search. Time spent by ground crews checking these sightings can limit overall search effort.
 - g. **For searches over water** - sea conditions will determine search effectiveness. Rough water, waves, choppy surfaces, and whitecaps can impede identification of people in the water. Whitecaps splashing over the head of a survivor limits detectability.

-
28. Searching over water presents different challenges to searching over land. Helicopter operations may be limited by the ability of the crew to maintain continuous visual contact using NVIS with land or a shoreline, including any illumination levels and potential hover references. Large areas of open water such as oceans can be difficult to comprehensively search. Operations in close proximity to coastline, islands or other obstacles can limit ability to search at optimum search altitude due to minimum safe altitude requirements.
 29. A more finite and smaller search area would benefit from a low altitude and slow speed search however a vast expansive search area such as in an open rural environment might require a higher altitude and faster search speed to cover. Higher probability locations may need smaller and repeated sweep widths or multiple orbits depending on field of view and to vary the slant ranges to potentially reveal previously unseen detail. Lower altitudes and low search speeds are most suitable for searching for a person in the water.
 30. For best use of available aircraft search time, the best search progression will generally be in order of firstly covering the Last Known Position, then the intended route, likely routes or locations based on local knowledge and intelligence, before a broad area search. For overwater searches, search planners will need to allow for drift of the target.
 31. Search pattern and sweep width choice and suitability will be dependent on the various factors described in this guidance and should be guided by aircrew expertise. Search patterns using parallel legs may be best in some cases while flying orbits/circular patterns may be better. Adjustments may be required when the aircraft arrives in the search area due to the conditions encountered and aircrews should be provided with flexibility to adjust their search parameters where possible.
 32. Search altitude variations may be applicable depending on the type of search, search aircraft type, its electronic night search capability and aviation regulatory requirements. The lowest safe search altitude at night over land is terrain and weather dependant but generally 1,500 – 2,000 feet above ground level (AGL) would be reasonable. For helicopters with NVIS capability and regulatory approval, lower altitudes may be possible where conditions allow, and it is safe to do so. Higher search altitudes may be optimal such as the those generally flown by AMSA’s Challenger CL604 using a circle search technique which would normally be flown between 5,000 – 10,000 feet AGL and typically not above 15,000 feet AGL. As different aircraft operators, both civil and military, may have different capabilities and regulatory authorisations, SAR coordinators should be guided by the operator/aircrew on a case-by-case basis when planning search altitudes.
 33. Searching areas of thick vegetation such as forested areas can be difficult. Searching over forested areas can be more effective at a higher altitude to allow for a higher viewing angle through the tree canopy. Circling an area of thick vegetation to provide a view from different angles may also assist.
 34. EO/IR and NVIS can fail to detect a person due to the limitations and variables outlined in this guidance, and depending on where and how they are situated, for example under thick vegetation, covered in mud, etc. Search planning decisions made regarding potentially discounting areas searched by EO/IR and NVIS need to be carefully considered and searching those areas again by different search methods are likely to be needed for better search integrity.
 35. Sector searches over a datum improve detectability through the cumulative effect of repeatedly covering the datum area. Circular patterns or orbits may also offer the same effect.
 36. Most night search operations are likely to occur outside controlled airspace and where more than one aircraft is to be used for searching in the same area, as for day searches, those aircraft should be planned to allow aircrew to maintain deconflicted operations, both laterally and vertically, not only for safety

purposes but also to maximise available search time while minimising the need for pilots to organise self-separation with other aircraft. For helicopter NVD operations, Australian civil aviation rules (*CAO 82.6, Appendix 3, 12 Close proximity flights*) require those flights operating in close proximity to another aircraft to be a minimum of 250 metres horizontally and 500 feet vertically apart and to be arranged and discussed between the pilots in command of those aircraft before the close proximity flight begins. For operations within controlled airspace, Air Traffic Services (ATS) requirements will need to be factored into the planning in consultation with the responsible ATS unit.

Surface unit support

37. The success of night searches can be dependent on surface (land or marine) unit support to investigate sightings by search aircraft. The deployment of surface units in the search area in support of the aircraft night search may also assist the aircrew to establish suitable reference parameters for their sensor equipment for the search conditions.
38. Where aircraft and surface resources are to search concurrently, identification of high probability areas suitable for air search while surface resources search more easily accessible areas can provide more efficient search area coverage.
39. Where surface search personnel are likely to be present there should be a method for the aircraft search crew to easily identify them, for example, radio communications, identifying light signals, and IR strobes where aircraft NVIS are used. Surface units may be assisted by search aircraft to locate distress locations or identify a point of interest, for example by use of helicopter search lights to illuminate a search location or use of search aircraft laser systems

NOTE – see precautions regarding aircraft laser systems in *Aircraft and equipment factors* section above.

40. Helicopter night winching has limitations, especially overwater, where a suitable visual reference is required or an auto-hover capability. NVIS capability may assist to safely permit a night winching within regulatory requirements, however, using surface unit support to investigate sightings or perform a rescue presents a lower risk option.

Circle Search technique - General guidance

41. A circle search is based on the search aircraft having the capability to search using a combination of EO/IR and NVIS operating at a fixed distance around a datum. As the aircraft flies the circular search pattern, the aircraft's NVIS and EO/IR are used as search sensors. Observers are afforded a broad but less detailed view of the search area utilising NVIS while EO/IR may provide both a wide field of view for target acquisition and a detailed, narrow field of view for target investigation. Due to the nature of this search technique and aircraft bank angle, observers and search equipment only search from the one side of the aircraft, i.e., towards the inside of the circle.
42. The circle search flight profile depends on three key inputs:
 - a. A datum to define the centre of the search area;
 - b. A search radius, typically 3NM for faster fixed-wing aircraft, to balance search area coverage against the aircraft's NVIS and EO/IR capability, aircraft handling characteristics and search platform stability. The optimum radius will depend on the aircraft performance limitations; and
 - c. An altitude, normally between 5,000-10,000ft AGL and typically not above 15,000ft for aircraft capable of higher altitudes.

Appendices

-
43. Search planners need to be guided by the aircrew as to the optimum circle search radius, search altitude and speed.
 44. The search area should be relatively confined and made up of terrain considered suitable for a circle search.
 45. Before the search is initiated, the aircrew sensor operator breaks the search area into several smaller areas defined by human made or geographic boundaries such as roads, rivers, and property lines. Multiple orbits of the search area allow for each sub-area to be observed from multiple angles until the crew is confident the entire area has been searched as effectively as possible within the limits of the aircraft sensor capability and search conditions. For this reason, circle searches are ordinarily confined to land areas and are not normally appropriate for over water searches due to the lack of maritime surface features available. However, if multiple fixed points of reference are available overwater, like islands, reefs, and mud flats, then a circle search may be an option if the search area is geographically constrained to those areas.
 46. For broader areas, several circle searches may be combined adjacent to each other to complete that area in stages, for example a search along a track. This is dependent, of course, on aircraft endurance, crew duty time and on-scene search time available.
 47. The number of circle searches required will depend on the time taken to clear each individual search area and this will depend on the nature of the terrain, weather, light levels, and aircrew operator skill.
 48. The nature of terrain will determine the ideal search altitude. For example, heavily wooded or mountainous terrain are best searched at higher altitudes to improve the look down capability of the EO/IR, but the ideal search height will always be secondary to the Lowest Safe Altitude.
 49. Cloud and/or poor visibility may compromise a circle search; however, the EO/IR capability can be utilised to look through cloud breaks where they occur.
 50. When search planners are considering tasking suitably capable aircraft for a sector or expanding square search, the use of a circle search should also be considered.